

## 2-INPUT 3CHANNEL VIDEO SWITCH

### ■ GENERAL DESCRIPTION

NJM2283 is a switching IC for switching over from one audio or video input signal to another. Internalizing 2 inputs and 1 output, and then each set of 3 can be operated independently. It is a higher efficiency video switch, featuring the supply voltage range 4.75 to 13.0V, the frequency feature 10MHz, and then Crosstalk 75dB (at 4.43MHz).

### ■ FEATURES

- 2 Input-1 Output 3 Circuits internalizing
- Wide Operating Voltage (4.75 ~ 13.0V)
- Crosstalk 75dB(at 4.43MHz)
- Wide Operating Supply Range 10MHz(2V<sub>P-P</sub> Input)
- Wide Bandwidth Frequency
- Package Outline DIP16, DMP16, SSOP16

### ■ APPLICATIONS

VCR, Video Camera, AV-TV, Video Disk Player.

### ■ PACKAGE OUTLINE

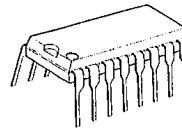

NJM2283D

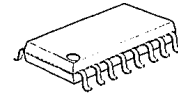

NJM2283M

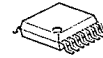

NJM2283V

### ■ BLOCK DIAGRAM

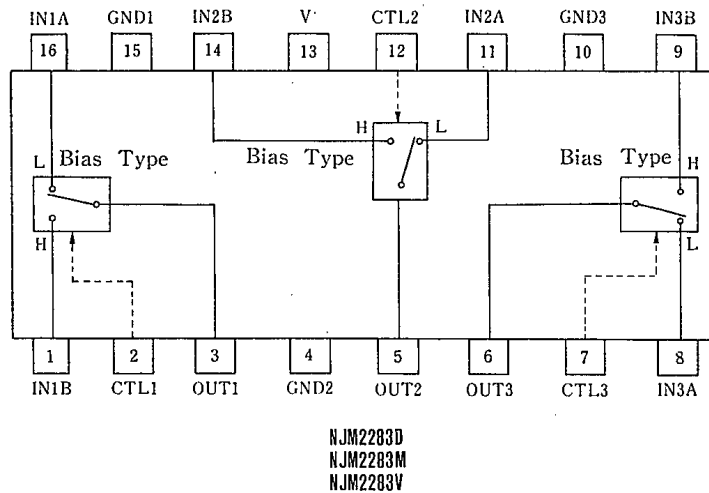

## ■ MAXIMUM RATINGS

(Ta=25°C)

PARAMETER	SYMBOL	RATINGS	UNIT
Supply Voltage	V <sup>+</sup>	14	V
Power Dissipation	P <sub>D</sub>	(DIP16) 700	mW
		(DMP16) 350	mW
		(SSOP16) 300	mW
Operating Temperature Range	T <sub>opr</sub>	-40~+85	°C
Storage Temperature Range	T <sub>stg</sub>	-40~+125	°C

## ■ ELECTRICAL CHARACTERISTICS

(V<sup>+</sup>=5V, Ta=25°C)

PARAMETER	SYMBOL	TEST CONDITION	MIN.	TYP.	MAX.	UNIT
Operating Current (1)	I <sub>CC1</sub>	V <sup>+</sup> =5V (Note1)	8.3	11.8	15.3	mA
Operating Current (2)	I <sub>CC2</sub>	V <sup>+</sup> =9V (Note1)	10.4	14.8	19.2	mA
Voltage Gain	G <sub>V</sub>	V <sub>I</sub> = 100kHz, 2V <sub>P-P</sub> , V <sub>O</sub> /V <sub>I</sub>	-0.6	-0.1	+0.4	dB
Frequency Gain	G <sub>F</sub>	V <sub>I</sub> = 2V <sub>P-P</sub> , V <sub>O</sub> (10MHz)/V <sub>O</sub> (100kHz)	-1.0	0	+1.0	dB
Differential Gain	DG	V <sub>I</sub> = 2V <sub>P-P</sub> , Standard Staircase Signal	—	0.3	—	%
Differential Phase	DP	V <sub>I</sub> = 2V <sub>P-P</sub> , Standard Staircase Signal	—	0.3	—	deg
Output Offset Voltage	V <sub>OS</sub>	(Note2)	-10	0	+10	mV
Crosstalk	CT	V <sub>I</sub> = 2V <sub>P-P</sub> , 4.43MHz, V <sub>O</sub> /V <sub>I</sub>	—	-75	—	dB
Switch Change Over Voltage	V <sub>CH</sub>	All inside switch ON	2.5	—	—	V
Switch Change Over Voltage	V <sub>CL</sub>	All inside switch OFF	—	—	1.0	V

(Note1) S1=S2=S3=S4=S5=S6=S7=1

(Note2) S1=S2=S3=S4=S5=S6=1, S7=1→2 Measure the output DC voltage difference

## ■ TERMINAL EXPLANATION

PIN No.	PIN NAME	VOLTAGE	INSIDE EQUIVALENT CIRCUIT
16 1 11 14 8 9	IN 1 A IN 1 B IN 2 A IN 2 B IN 3 A IN 3 B (Input)	2.5V	
2 12 7	CTL 1 CTL 2 CTL 3 (Switching)		
3 5 6	OUT 1 OUT 2 OUT 3 (Output)	1.8V	
13	V+	5V	
15 4 10	GND 1 GND 2 GND 3		

5

## TEST CIRCUIT

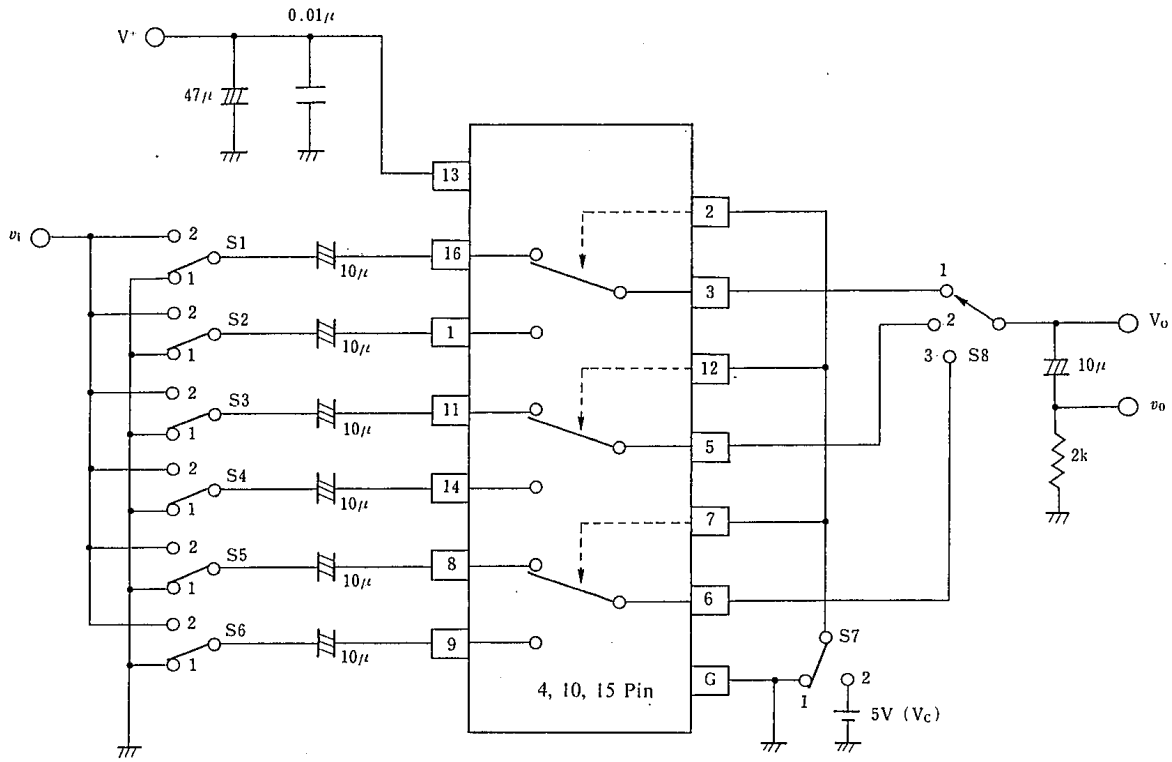

5

Parameter	S 1	S 2	S 3	S 4	S 5	S 6	S 7	S 8	Test Part
I <sub>cc1</sub>	1	1	1	1	1	1	1	1	V <sup>+</sup>
I <sub>cc2</sub>	1	1	1	1	1	1	1	1	V <sup>+</sup>
G <sub>v1</sub>	2	1	1	1	1	1	1	1	v <sub>o</sub>
G <sub>f1</sub>	2	1	1	1	1	1	1	1	v <sub>o</sub>
DG <sub>1</sub>	2	1	1	1	1	1	1	1	v <sub>o</sub>
DP <sub>1</sub>	2	1	1	1	1	1	1	1	v <sub>o</sub>
CT 1	2	1	1	1	1	1	2	1	v <sub>o</sub>
CT 2	1	2	1	1	1	1	1	1	v <sub>o</sub>
CT 3	1	1	2	1	1	1	2	2	v <sub>o</sub>
CT 4	1	1	1	2	1	1	1	2	v <sub>o</sub>
CT 5	1	1	1	1	2	1	2	3	v <sub>o</sub>
CT 6	1	1	1	1	1	2	1	3	v <sub>o</sub>
V <sub>OS1</sub>	1	1	1	1	1	1	1/2	1	V <sub>o</sub>
V <sub>c1</sub>	1/2	2/1	1	1	1	1	V <sub>c</sub>	1	V <sub>c</sub>
THD	2	1	1	1	1	1	1	1	v <sub>o</sub>

■ TYPICAL CHARACTERISTICS

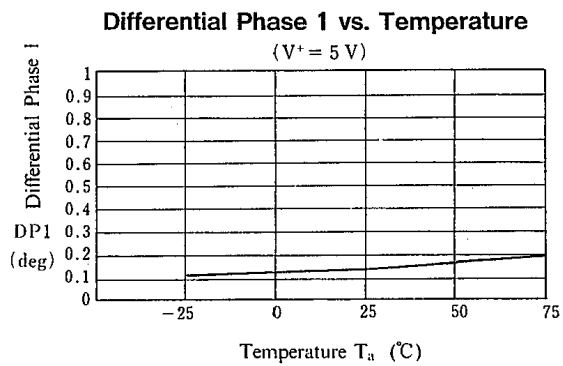
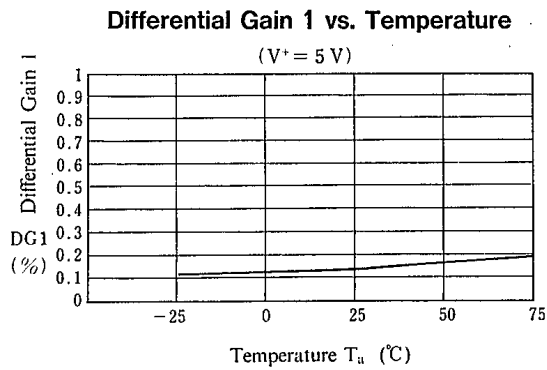
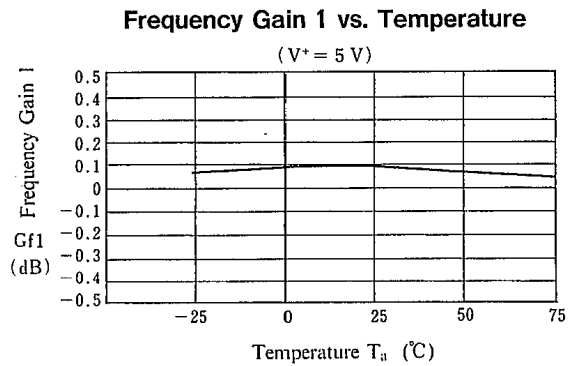
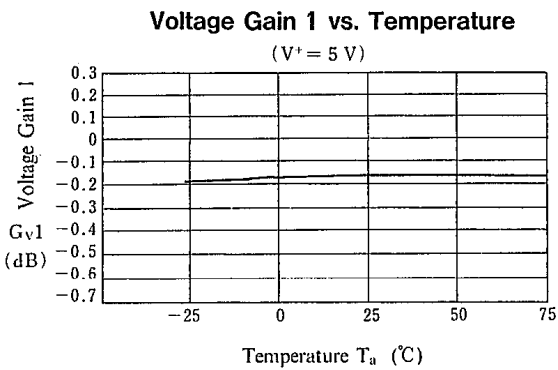
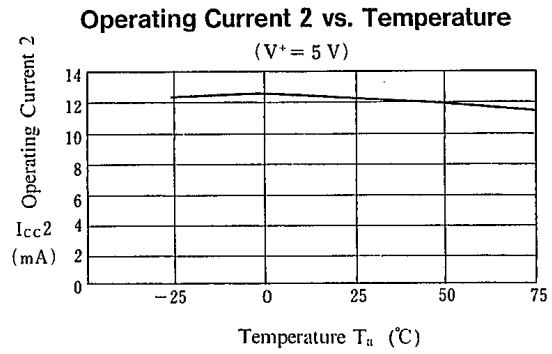
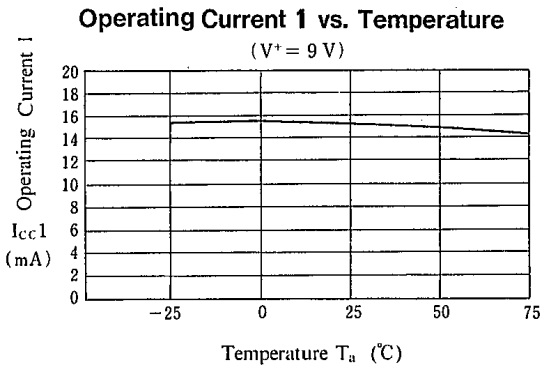

## ■ TYPICAL CHARACTERISTICS

**Offset Voltage 1 vs. Temperature**

( $V^+ = 5\text{ V}$ )

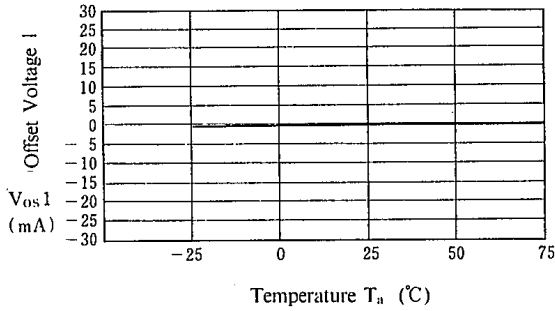

**Crosstalk 1 vs. Temperature**

( $V^+ = 5\text{ V}$ )

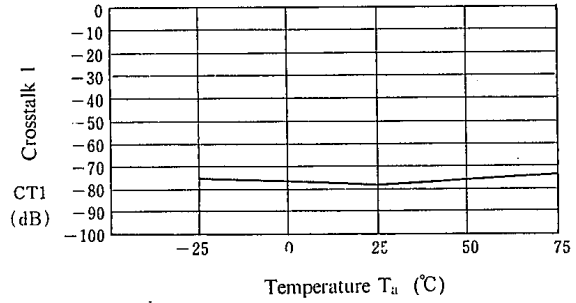

**Crosstalk 2 vs. Temperature**

( $V^+ = 5\text{ V}$ )

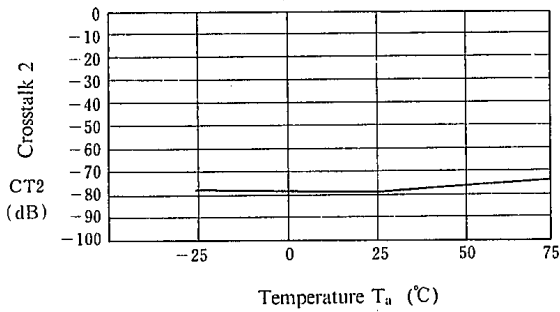

**Crosstalk 3 vs. Temperature**

( $V^+ = 5\text{ V}$ )

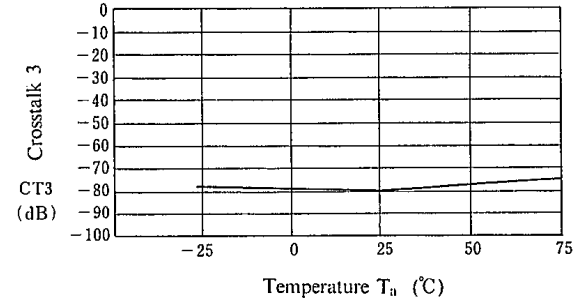

**Crosstalk 4 vs. Temperature**

( $V^+ = 5\text{ V}$ )

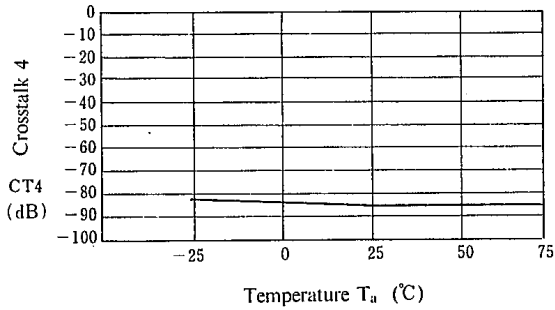

**Crosstalk 5 vs. Temperature**

( $V^+ = 5\text{ V}$ )

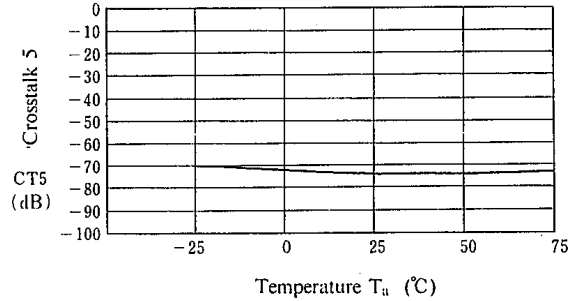

5

## TYPICAL CHARACTERISTICS

### Crosstalk 6 vs. Temperature

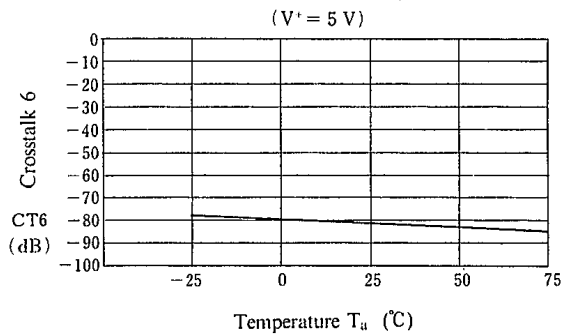

### Switch Change Over 1 vs. Operating Voltage

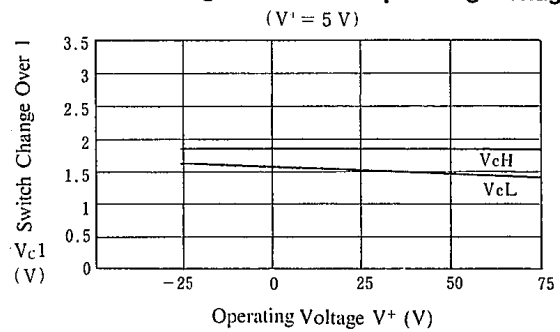

### Operating Current vs. Operating Voltage

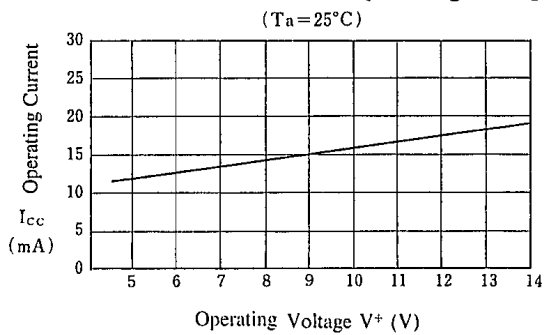

### Voltage Gain 1 vs. Operating Voltage

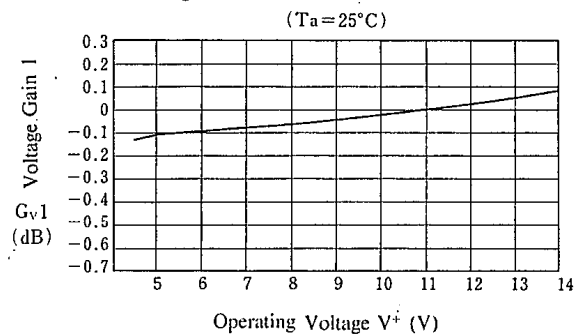

### Frequency Gain 1 vs. Operating Voltage

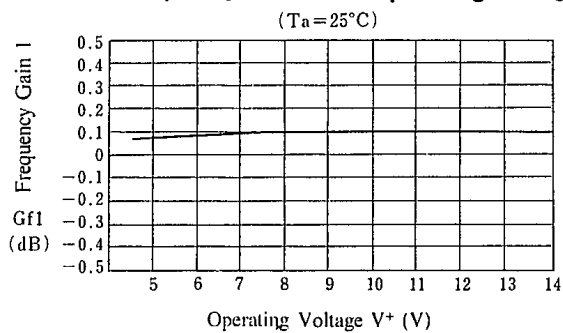

### Differential Gain 1 vs. Operating Voltage

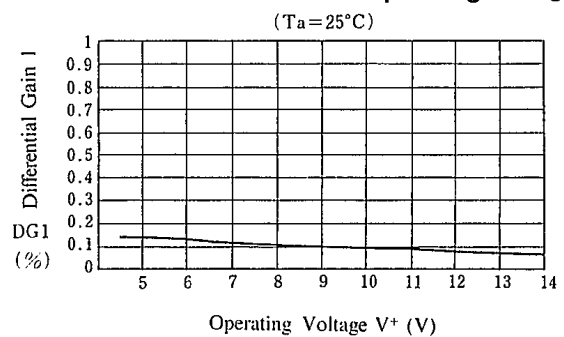

## ■ TYPICAL CHARACTERISTICS

Differential Phase 1 vs. Operating Voltage

( $T_a = 25^\circ\text{C}$ )

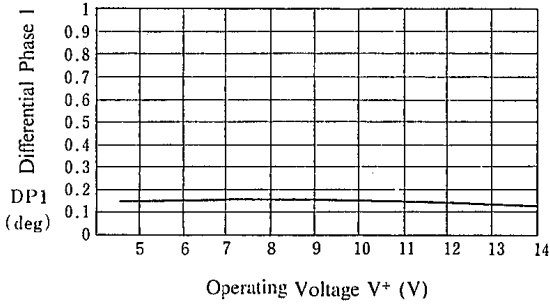

Offset Voltage 1 vs. Operating Voltage

( $T_a = 25^\circ\text{C}$ )

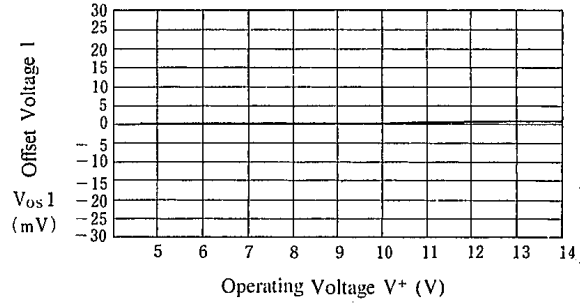

Crosstalk 1 vs. Operating Voltage

( $T_a = 25^\circ\text{C}$ )

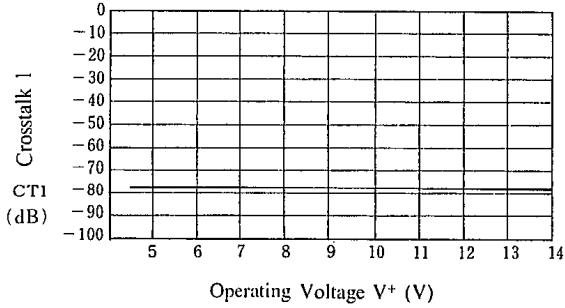

Crosstalk 2 vs. Operating Voltage

( $T_a = 25^\circ\text{C}$ )

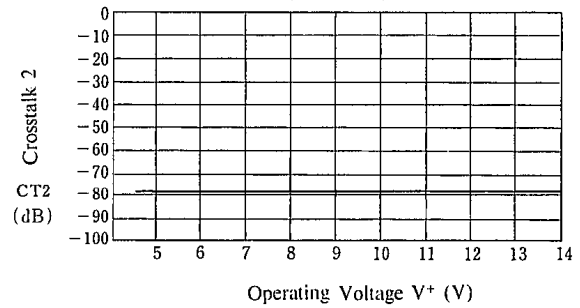

Crosstalk 3 vs. Operating Voltage

( $T_a = 25^\circ\text{C}$ )

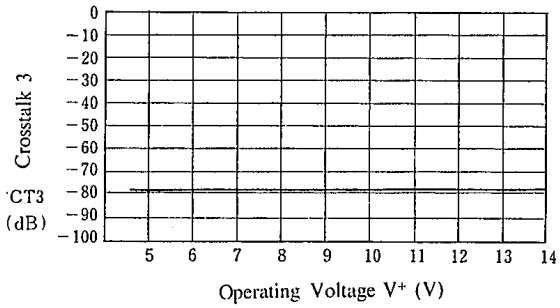

Crosstalk 4 vs. Operating Voltage

( $T_a = 25^\circ\text{C}$ )

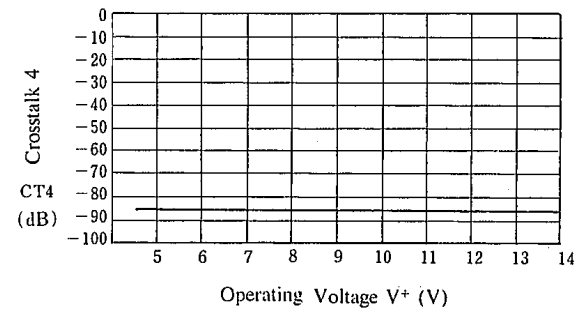

5



■ TYPICAL CHARACTERISTICS

Crosstalk 5 vs. Operating Voltage

( $T_a=25^\circ\text{C}$ )

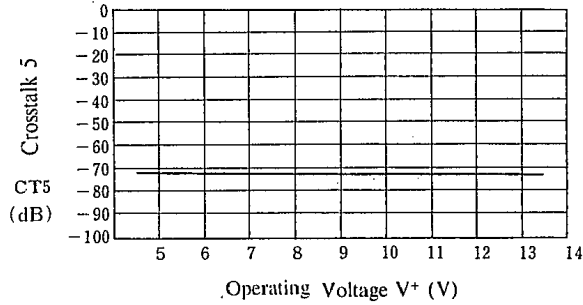

Crosstalk 6 vs. Operating Voltage

( $T_a=25^\circ\text{C}$ )

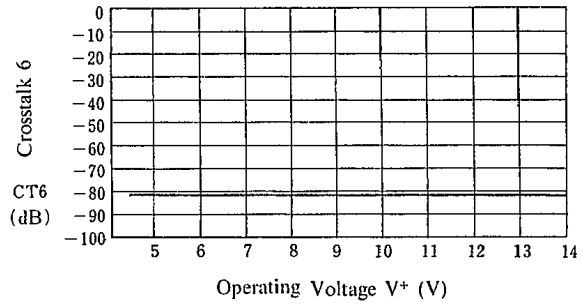

Switch Change Over 1 vs. Operating Voltage

( $T_a=25^\circ\text{C}$ )

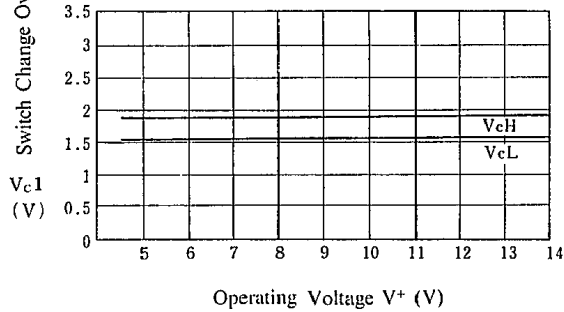

Voltage Gain 1 vs. Frequency Feature

( $T_a=25^\circ\text{C}$ )

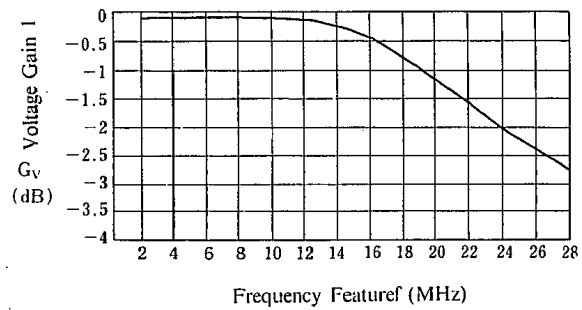

Differential Gain 1 vs. Load Resistor

( $T_a=25^\circ\text{C}$ )

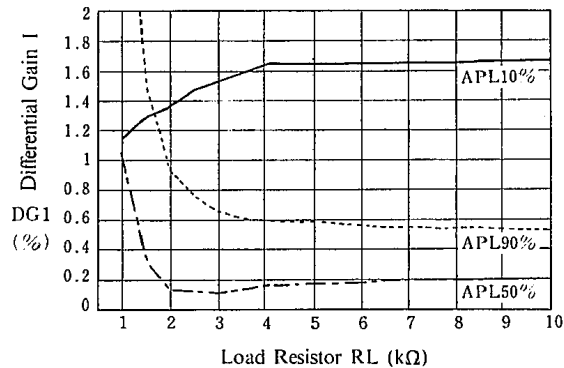

Differential Phase 1 vs. Load Resistor

( $T_a=25^\circ\text{C}$ )

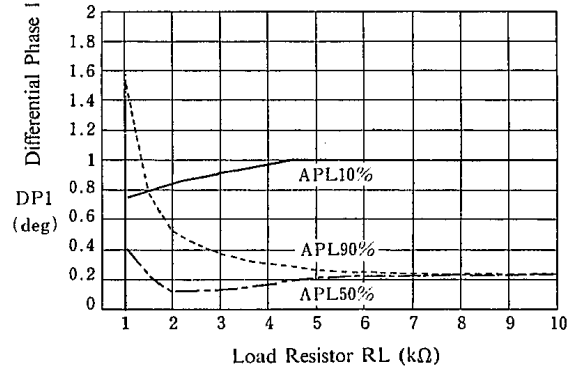

## ■ TYPICAL CHARACTERISTICS

**Differential Gain 1 vs. APL**  
( $T_a = 25^\circ\text{C}$ )

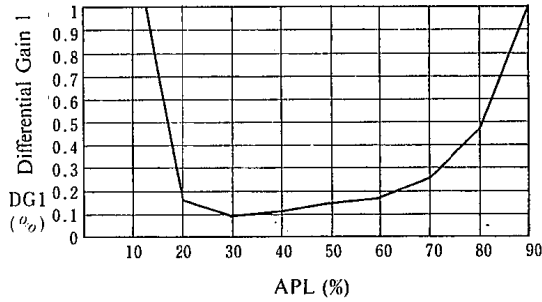

**Differential Phase 1 vs. APL**  
( $T_a = 25^\circ\text{C}$ )

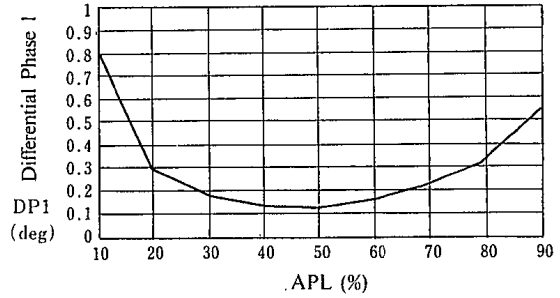

**Total Harmonic Distortion vs. Load Resistor**  
( $T_a = 25^\circ\text{C}$ )

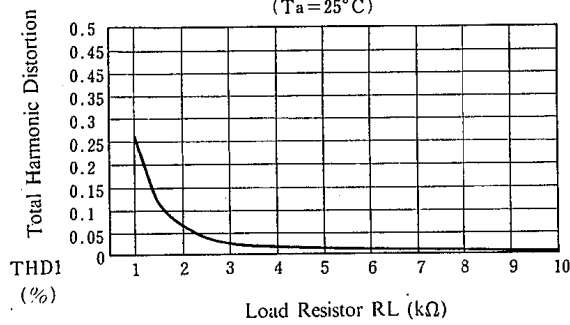

5

## MEMO

**[CAUTION]**

The specifications on this databook are only given for information, without any guarantee as regards either mistakes or omissions. The application circuits in this databook are described only to show representative usages of the product and not intended for the guarantee or permission of any right including the industrial rights.