

Silicon PIN Photodiode

Description

S153P is a high speed and high sensitive PIN photodiode in a hermetically sealed short TO-5 package. Due to its flat, waterclear glass window the device is sensitive to visible and near infrared radiation. The large active area combined with a flat case gives a high sensitivity at a wide viewing angle.

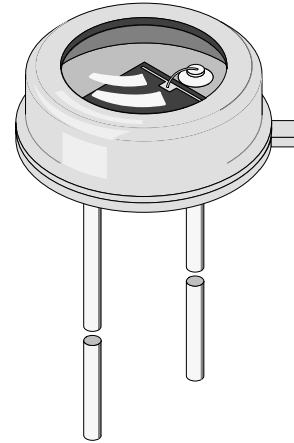

94 8482

Features

- High photo sensitivity
- Large radiant sensitive area $A=7.5 \text{ mm}^2$
- Fast response times
- Small junction capacitance
- For photodiode and photovoltaic operation
- Hermetically sealed case
- Wide angle of half sensitivity $\varphi = \pm 55^\circ$
- Suitable for visible and near infrared radiation
- Suitable to couple with glass fiber

Applications

Applications requiring high speed and high sensitive PIN photodiodes in hermetically sealed packages.

Absolute Maximum Ratings

$T_{\text{amb}} = 25^\circ\text{C}$

Parameter	Test Conditions	Symbol	Value	Unit
Reverse Voltage		V_R	50	V
Power Dissipation	$T_{\text{amb}} \leq 50^\circ\text{C}$	P_V	300	mW
Junction Temperature		T_j	125	$^\circ\text{C}$
Operating Temperature Range		T_{amb}	-55...+125	$^\circ\text{C}$
Soldering Temperature	$t \leq 5 \text{ s}$	T_{sd}	260	$^\circ\text{C}$
Thermal Resistance Junction/Ambient		R_{thJA}	250	K/W

Basic Characteristics

$T_{amb} = 25^{\circ}\text{C}$

Parameter	Test Conditions	Symbol	Min	Typ	Max	Unit
Breakdown Voltage	$I_R = 100 \mu\text{A}, E = 0$	$V_{(BR)}$	50			V
Reverse Dark Current	$V_R = 10 \text{ V}, E = 0$	I_{ro}		2	30	nA
Diode Capacitance	$V_R = 0 \text{ V}, f = 1 \text{ MHz}, E = 0$	C_D		75		pF
	$V_R = 3 \text{ V}, f = 1 \text{ MHz}, E = 0$	C_D		25	40	pF
Open Circuit Voltage	$E_A = 1 \text{ klx}$	V_o		350		mV
Temp. Coefficient of V_o	$E_A = 1 \text{ klx}$	TK_{V_o}		-2.6		mV/K
Short Circuit Current	$E_A = 1 \text{ klx}$	I_k		80		μA
	$E_e = 1 \text{ mW/cm}^2,$ $\lambda = 950 \text{ nm}$	I_k		47		μA
Temp. Coefficient of I_k	$E_A = 1 \text{ klx}$	TK_{I_k}		0.18		%/K
Reverse Light Current	$E_A = 1 \text{ klx}, V_R = 5 \text{ V}$	I_{ra}		85		μA
	$E_e = 1 \text{ mW/cm}^2,$ $\lambda = 950 \text{ nm}, V_R = 5 \text{ V}$	I_{ra}	40	50		μA
Absolute Spectral Sensitivity	$V_R = 5 \text{ V}, \lambda = 900 \text{ nm}$	$s(\lambda)$		0.6		A/W
Angle of Half Sensitivity		φ		± 55		deg
Wavelength of Peak Sensitivity		λ_p		900		nm
Range of Spectral Bandwidth		$\lambda_{0.5}$		600...1050		nm
Noise Equivalent Power	$V_R = 10 \text{ V}, \lambda = 950 \text{ nm}$	NEP		4.2×10^{-14}		W/ $\sqrt{\text{Hz}}$
Rise Time	$V_R = 10 \text{ V}, R_L = 1 \text{ k}\Omega,$ $\lambda = 820 \text{ nm}$	t_r		100		ns
Fall Time	$V_R = 10 \text{ V}, R_L = 1 \text{ k}\Omega,$ $\lambda = 820 \text{ nm}$	t_f		100		ns

Typical Characteristics ($T_{amb} = 25^{\circ}\text{C}$ unless otherwise specified)

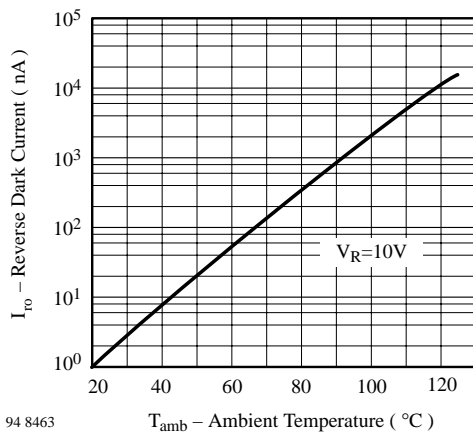

Figure 1. Reverse Dark Current vs. Ambient Temperature

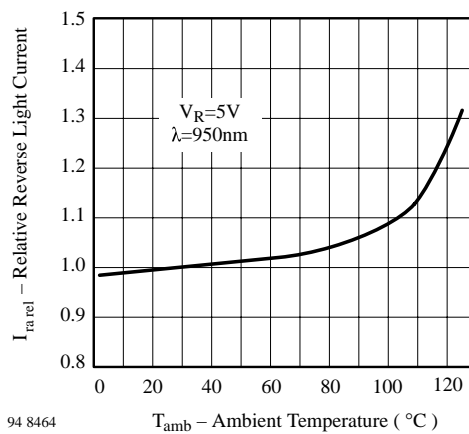

Figure 2. Relative Reverse Light Current vs. Ambient Temperature

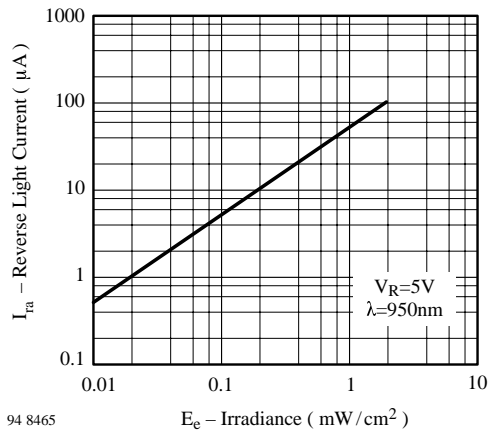

Figure 3. Reverse Light Current vs. Irradiance

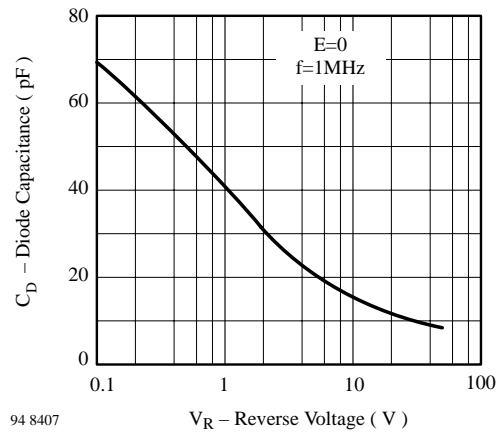

Figure 6. Diode Capacitance vs. Reverse Voltage

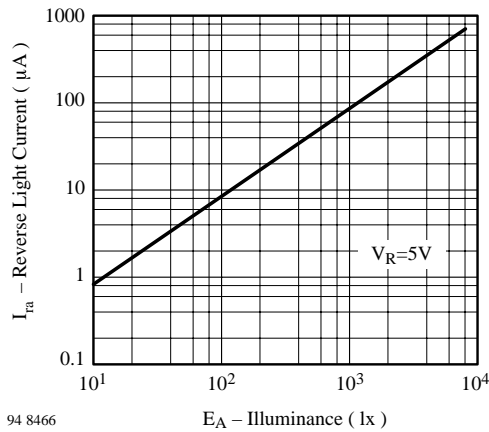

Figure 4. Reverse Light Current vs. Illuminance

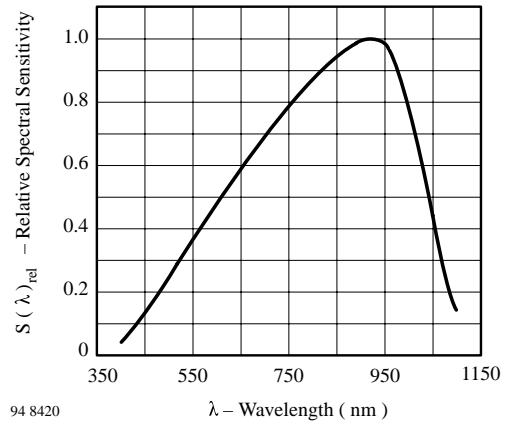

Figure 7. Relative Spectral Sensitivity vs. Wavelength

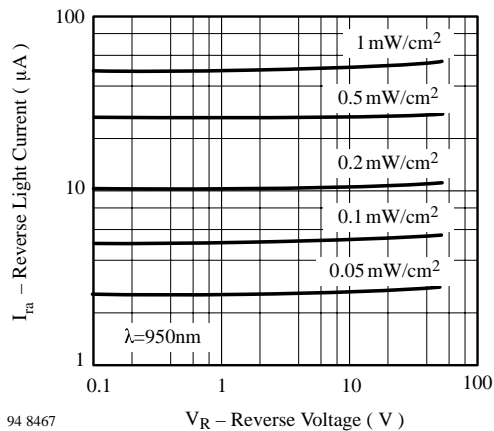

Figure 5. Reverse Light Current vs. Reverse Voltage

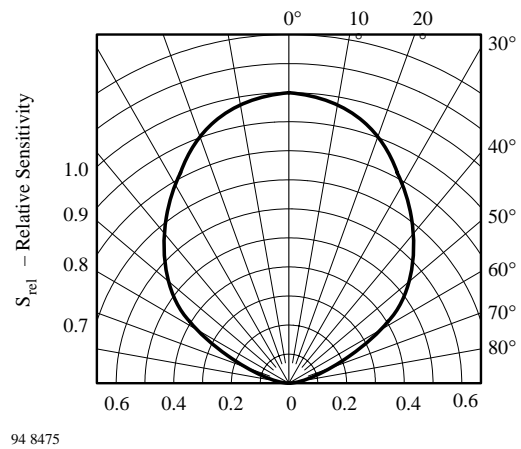
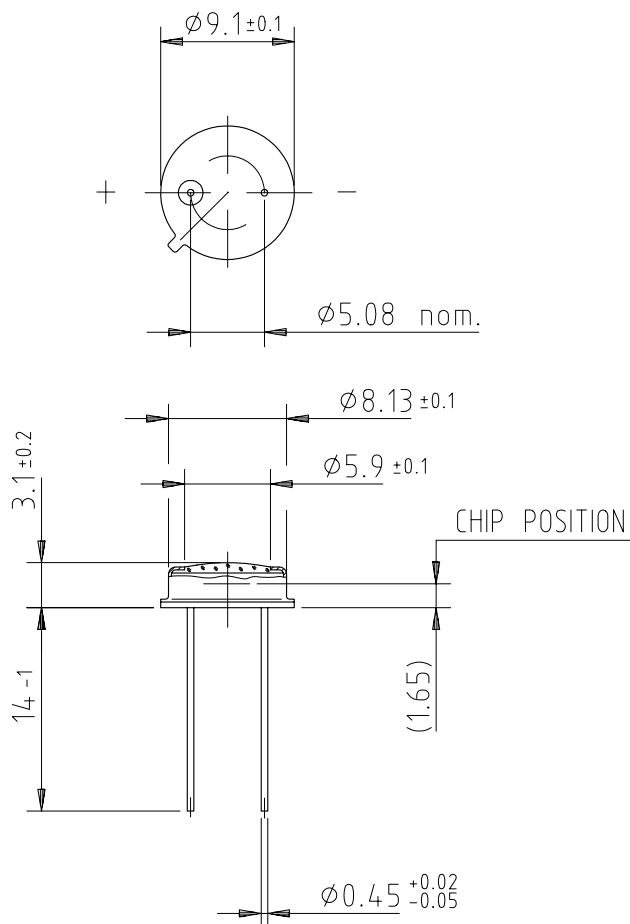
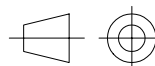

Figure 8. Relative Radiant Sensitivity vs. Angular Displacement

Dimensions in mm



96 12181



technical drawings
according to DIN
specifications



Ozone Depleting Substances Policy Statement

It is the policy of **Vishay Semiconductor GmbH** to

1. Meet all present and future national and international statutory requirements.
2. Regularly and continuously improve the performance of our products, processes, distribution and operating systems with respect to their impact on the health and safety of our employees and the public, as well as their impact on the environment.

It is particular concern to control or eliminate releases of those substances into the atmosphere which are known as ozone depleting substances (ODSs).

The Montreal Protocol (1987) and its London Amendments (1990) intend to severely restrict the use of ODSs and forbid their use within the next ten years. Various national and international initiatives are pressing for an earlier ban on these substances.

Vishay Semiconductor GmbH has been able to use its policy of continuous improvements to eliminate the use of ODSs listed in the following documents.

1. Annex A, B and list of transitional substances of the Montreal Protocol and the London Amendments respectively
2. Class I and II ozone depleting substances in the Clean Air Act Amendments of 1990 by the Environmental Protection Agency (EPA) in the USA
3. Council Decision 88/540/EEC and 91/690/EEC Annex A, B and C (transitional substances) respectively.

Vishay Semiconductor GmbH can certify that our semiconductors are not manufactured with ozone depleting substances and do not contain such substances.

We reserve the right to make changes to improve technical design and may do so without further notice.

Parameters can vary in different applications. All operating parameters must be validated for each customer application by the customer. Should the buyer use Vishay-Telefunken products for any unintended or unauthorized application, the buyer shall indemnify Vishay-Telefunken against all claims, costs, damages, and expenses, arising out of, directly or indirectly, any claim of personal damage, injury or death associated with such unintended or unauthorized use.

Vishay Semiconductor GmbH, P.O.B. 3535, D-74025 Heilbronn, Germany
Telephone: 49 (0) 7131 67 2831, Fax number: 49 (0) 7131 67 2423