

TRANSISTOR COUPLER

MT5350

GaAs INFRARED EMITTING DIODE & NPN SILICON PHOTO TRANSISTOR

T-41-83

APPLICATIONS

- AC LINE/DIGITAL LOGIC ISOLATOR
- DIGITAL LOGIC/DIGITAL LOGIC ISOLATOR
- TELEPHONE LINE RECEIVER
- TWISTED PAIR LINE RECEIVER
- HIGH FREQUENCY POWER SUPPLY FEEDBACK CONTROL
- RELAY CONTACT MONITOR

The MT5350 consists of a gallium arsenide infrared emitting diode coupled with a silicon photo transistor in a dual in-line package.

FEATURES

- Small package size and low cost.
- Fast switching speeds: 5μs.
- High DC current transfer ratio: *50% Min.
*CTR Rank (@ I_F = 10mA, V_{CE} = 10V).
Standard Type: 50% Min.
Selected Rank GB: 100% Min.
Selected Rank BL: 200% Min.
- High isolation resistance: 10¹¹Ω.
- High isolation voltage: 2500 V_{RMS}.
- UL recognized.

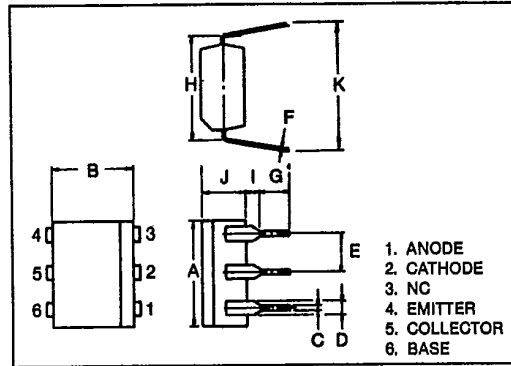

SYMBOL	INCHES	MM
A	0.280 ± 0.010	7.12 ± 0.25
B	0.252	6.40
C	0.020	0.50
D	0.047	1.20
E	0.1 TYP	2.54 TYP
F	0.010	0.25
G	0.100 MIN	2.50 MIN
H	0.300	7.62
I	0.031	0.80
J	0.144	3.65
K	0.309 ~ 3.465	7.85 ~ 8.80

PIN CONFIGURATIONS (TOP VIEW)

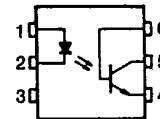

TRANSISTOR COUPLER

T-41-83

MAXIMUM RATINGS (Ta = 25°C)

	CHARACTERISTIC	SYMBOL	RATING	UNIT
A	Forward Current	I _F	60	mA
	Forward Current Derating	ΔI _F /°C	0.8*	mA/°C
	Peak Forward Current (Note)	I _{pF}	3	A
	Power Dissipation	P _D	100	mW
	Power Dissipation Derating	ΔP _D /°C	1.33*	mW/°C
	Reverse Voltage	V _R	3	V
B	Collector-Emitter Voltage	V _{CEO}	35	V
	Collector-Base Voltage	V _{CBO}	70	V
	Emitter-Collector Voltage	V _{ECO}	7	V
	Collector Current	I _C	100	mA
	Power Dissipation	P _C	150	mW
	Power Dissipation Derating	ΔP _C /°C	2.0*	mW/°C
C	Storage Temperature Range	T _{stg}	-55 ~ 150	°C
	Operating Temperature Range	T _{opr}	-55 ~ 100	°C
	Lead Soldering Temperature (at 10 sec.)	T _{sold}	260	°C
	Total Package Dissipation	P _T	200	mW
	Total Package Power Dissipation Derating	ΔP _T /°C	2.6*	mW/°C

Note: Pulse Width 1μs, 300pps.

*Above 25°C ambient.

OPTO-ELECTRICAL CHARACTERISTICS (Ta = 25°C)

	CHARACTERISTIC	SYMBOL	TEST CONDITION	MIN.	TYP.	MAX.	UNIT	
A	Forward Voltage	V _F	I _F = 10mA	1.0	1.15	1.3	V	
	Reverse Current	I _R	V _R = 3V	—	—	100	μA	
	Capacitance	C _D	V = 0, f = 1MHz	—	30	—	pF	
B	DC Forward Current Gain	h _{FE}	V _{CE} = 5, I _C = 500μA	100	200	—	—	
	Collector-Emitter Breakdown Voltage	V _{(BR)CEO}	I _C = 1mA, I _F = 0	35	—	—	V	
	Collector-Base Breakdown Voltage	V _{(BR)CBO}	I _C = 100μA, I _F = 0	70	—	—	V	
	Emitter-Collector Breakdown Voltage	V _{(BR)ECO}	I _E = 100μA, I _F = 0	7	—	—	V	
	Collector Dark Current	I _{CEO}	V _{CE} = 10V, I _F = 0	—	1	50	nA	
	Collector Dark Current	I _{CBO}	V _{CB} = 10V, I _F = 0	—	0.1	20	nA	
	Collector-Emitter Capacitance	C _{CE}	V = 0, f = 1MHz	—	10	—	pF	
	Current Transfer Ratio	I _C /I _F	GB	I _F = 10mA, V _{CE} = 10V	50	—	—	%
					100	—	—	
200					—	—		
Saturation Voltage	V _{CE(SAT)}	I _F = 10mA, I _C = 2mA	—	0.1	0.3	V		
Capacitance Input to Output	C _S	V = 0, F = 1MHz	—	0.8	—	pF		
Isolation Resistance	R _S	V = 500V	—	10 ¹¹	—	Ω		
C	AC Isolation Voltage	BV _S	AC 1 minute	2500	—	—	V _{RMS}	
	Peak Isolation Voltage	BV _S	Peak	3550	—	—	V	
Rise/Fall Time	t _r /t _f	V _{CE} = 10V, I _C = 2mA, R _L = 100Ω	—	5	—	μs		
Rise/Fall Time Photo Diode	t _r /t _f	V _{CB} = 10V, I _{CB} = 50μA, R _L = 100Ω	—	200	—	ns		
Turn-on Time	t _{on}	V _{CC} = 5V, R _L = 1.9kΩ	—	2	—	μs		
Storage Time	t _s	I _F = 16mA	—	12	—			
Turn-off Time	t _{off}	R _{BE} = 220kΩ	—	20	—			

A - LED B - PHOTO-TRANSISTOR C - COUPLED

TRANSISTOR COUPLER T-41-83

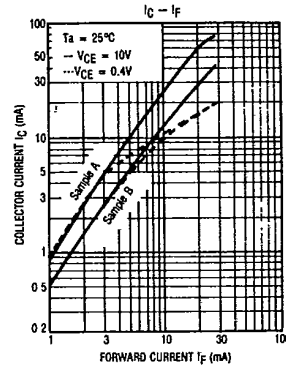
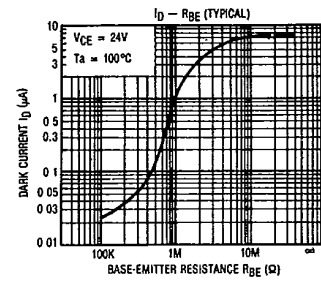
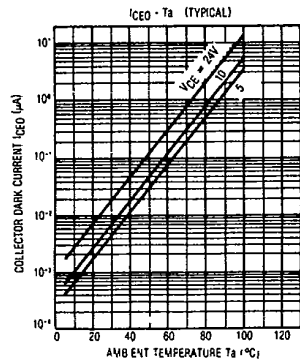
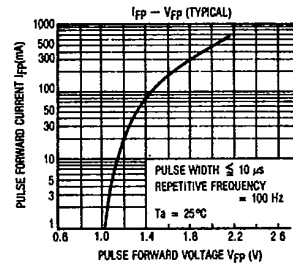
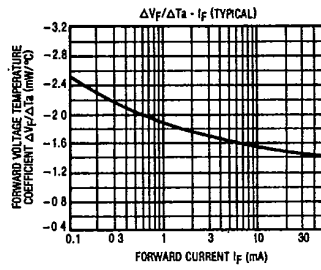
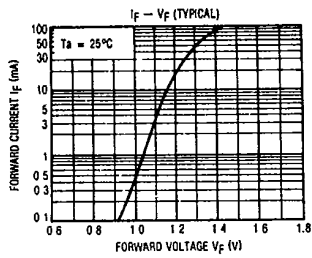
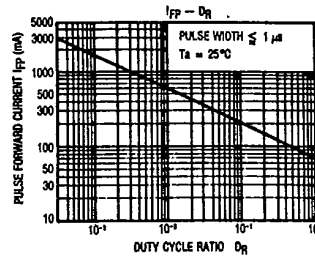
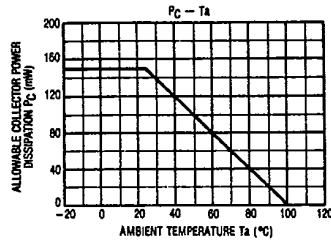
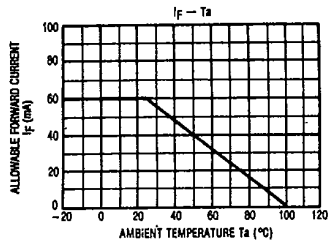

TRANSISTOR COUPLER

T-41-83

