

M54587P/FP

8-UNIT 500mA DARLINGTON TRANSISTOR ARRAY WITH CLAMP DIODE

DESCRIPTION

M54587P and M54587FP are eight-circuit collector-current-synchronized Darlington transistor arrays. The circuits are made of PNP and NPN transistors. Both the semiconductor integrated circuits perform high-current driving with extremely low input-current supply.

FEATURES

- High breakdown voltage ($BV_{CEO} \geq 50V$)
- High-current driving ($I_{C(max)} = 500mA$)
- "L" active level input
- With input diode
- With clamping diodes
- Wide operating temperature range ($T_a = -20$ to $+75^\circ C$)

APPLICATION

Interfaces between microcomputers and high-voltage, high-current drive systems, drives of relays and MOS-bipolar logic IC interfaces

FUNCTION

The M54587 is produced by adding PNP transistors to M54585 inputs. Eight circuits having active L-level inputs are provided.

Resistance of $7k\Omega$ and diode are provided in series between each input and PNP transistor base. The input diode is intended to prevent the flow of current from the input to the V_{CC} . Without this diode, the current flow from "H" input to the V_{CC} and the "L" input circuits is activated, in such case where one of the inputs of the 8 circuits is "H" and the others are "L" to save power consumption. The diode is inserted to prevent such misoperation.

This device is most suitable for a driver using NMOS IC output especially for the driver of current sink.

Collector current is 500mA maximum. Collector-emitter supply voltage is 50V.

The M54587FP is enclosed in a molded small flat package, enabling space saving design.

PIN CONFIGURATION

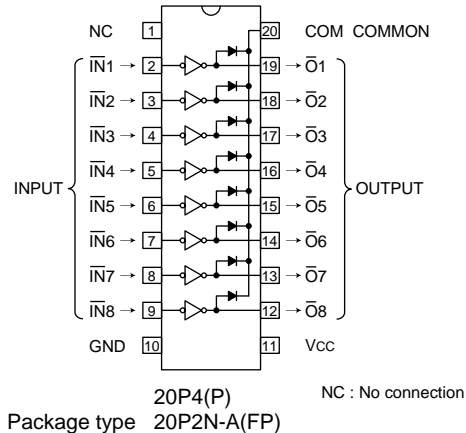

CIRCUIT DIAGRAM (EACH CIRCUIT)

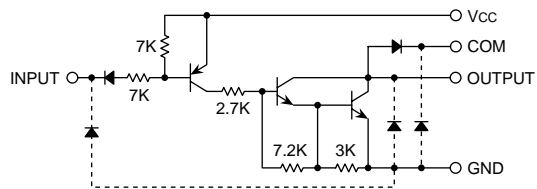

The eight circuits share the V_{CC} , COM and GND

The diode, indicated with the dotted line, is parasitic, and cannot be used.

Unit : Ω

8-UNIT 500mA DARLINGTON TRANSISTOR ARRAY WITH CLAMP DIODE

ABSOLUTE MAXIMUM RATINGS (Unless otherwise noted, Ta = -20 ~ +75°C)

Symbol	Parameter	Conditions	Ratings	Unit
Vcc	Supply voltage		10	V
VCEO	Collector-emitter voltage	Output, H	-0.5 ~ +50	V
Vi	Input voltage		-0.5 ~ Vcc	V
Ic	Collector current	Current per circuit output, L	500	mA
IF	Clamping diode forward current		500	mA
VR	Clamping diode reverse voltage		50	V
Pd	Power dissipation	Ta = 25°C, when mounted on board	1.79/1.1	W
Topr	Operating temperature		-20 ~ +75	°C
Tstg	Storage temperature		-55 ~ +125	°C

RECOMMENDED OPERATING CONDITIONS (Unless otherwise noted, Ta = -20 ~ +75°C)

Symbol	Parameter	Limits			Unit	
		min	typ	max		
Vcc	Supply voltage	4	5	8	V	
Ic	Collector current Per channel	Vcc = 5V, Duty Cycle P : no more than 6% FP : no more than 5%	0	—	400	mA
		Vcc = 5V, Duty Cycle P : no more than 34% FP : no more than 15%	0	—	200	
VIH	"H" input voltage	Vcc-0.7	—	Vcc	V	
VIL	"L" input voltage	0	—	Vcc-3.6	V	

ELECTRICAL CHARACTERISTICS (Unless otherwise noted, Ta = -40 ~ +85°C)

Symbol	Parameter	Test conditions	Limits			Unit	
			min	typ*	max		
V (BR) CEO	Collector-emitter breakdown voltage	ICEO = 100µA	50	—	—	V	
VCE(sat)	Collector-emitter saturation voltage	Vi = Vcc-3.6V	Ic = 400mA	—	1.2	2.4	V
			Ic = 200mA	—	0.95	1.6	
II	Input current	Vi = Vcc-3.6V	—	-290	-600	µA	
VF	Clamping diode forward voltage	IF = 400mA	—	1.4	2.4	V	
IR	Clamping diode reverse current	VR = 50V	—	0.1	100	µA	
Icc	Supply current (AN only Input)	Vcc = 5V, Vi = Vcc-3.5V	—	1.9	3	mA	
hFE	DC amplification factor	Vcc = 5V, VCE = 4V, Ic = 350mA, Ta = 25°C	2000	3500	—	—	

* : The typical values are those measured under ambient temperature (Ta) of 25°C. There is no guarantee that these values are obtained under any conditions.

SWITCHING CHARACTERISTICS (Unless otherwise noted, Ta = 25°C)

Symbol	Parameter	Test conditions	Limits			Unit
			min	typ	max	
ton	Turn-on time	CL = 15pF (note 1)	—	120	—	ns
toff	Turn-off time		—	2400	—	ns

M54587P/FP

8-UNIT 500mA DARLINGTON TRANSISTOR ARRAY WITH CLAMP DIODE

NOTE 1 TEST CIRCUIT

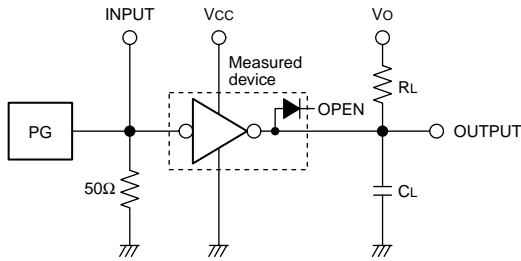

- (1) Pulse generator (PG) characteristics : PRR=1kHz, $t_w = 10\mu s$, $t_r = 6ns$, $t_f = 6ns$, $Z_o = 50\Omega$
 $V_i = 0.4 \sim 4V$
- (2) Input-output conditions : $R_L = 30\Omega$, $V_o = 10V$, $V_{cc} = 4V$
- (3) Electrostatic capacity C_L includes floating capacitance at connections and input capacitance at probes

TIMING DIAGRAM

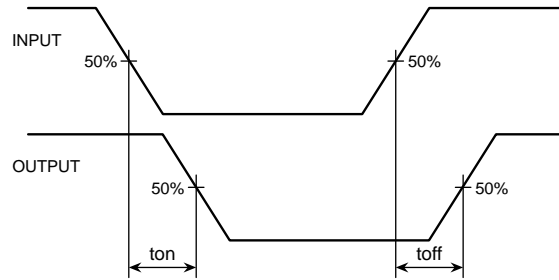

TYPICAL CHARACTERISTICS

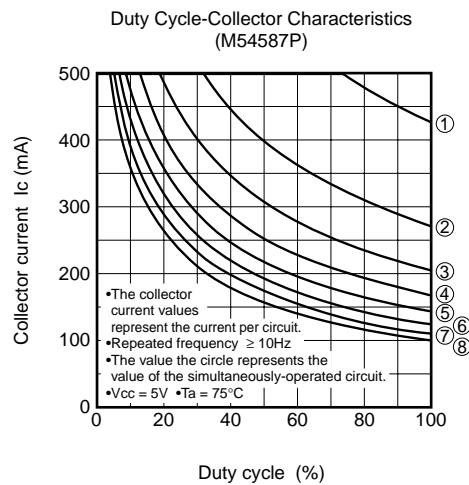
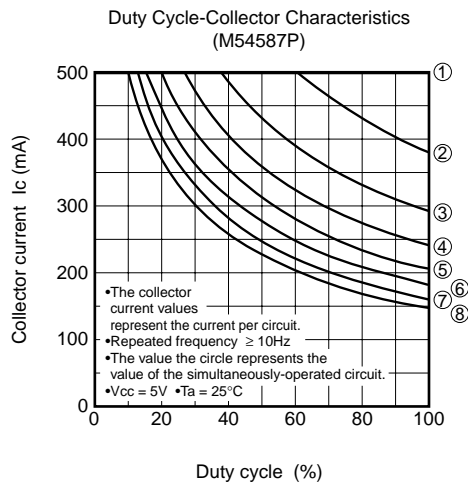
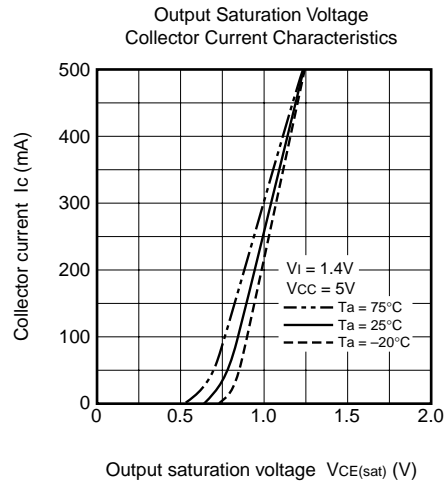
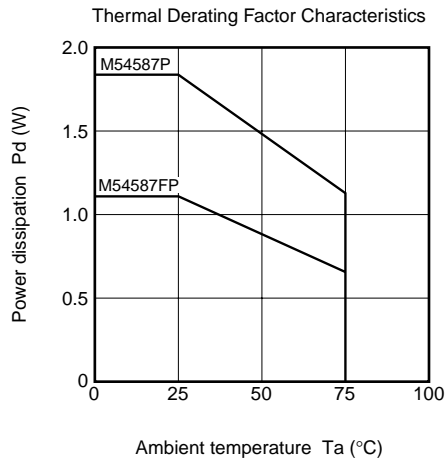

8-UNIT 500mA DARLINGTON TRANSISTOR ARRAY WITH CLAMP DIODE

Duty Cycle-Collector Characteristics (M54587FP)

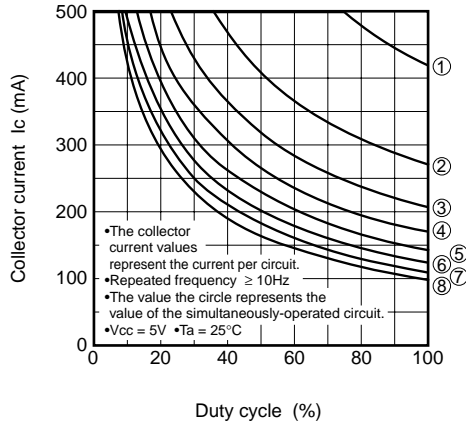

Duty Cycle-Collector Characteristics (M54587FP)

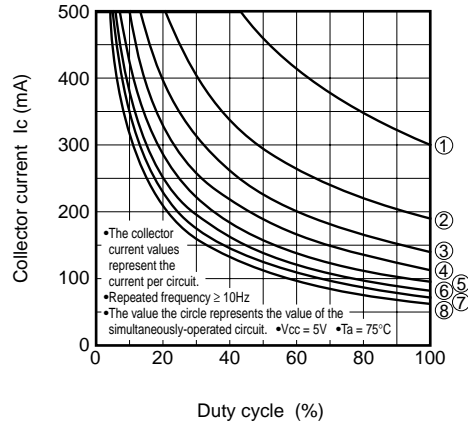

Output Current Characteristics

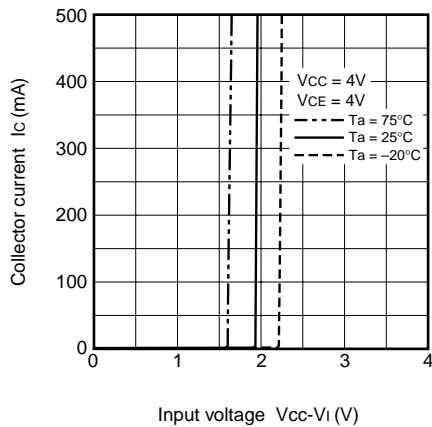

DC Amplification Factor Collector Current Characteristics

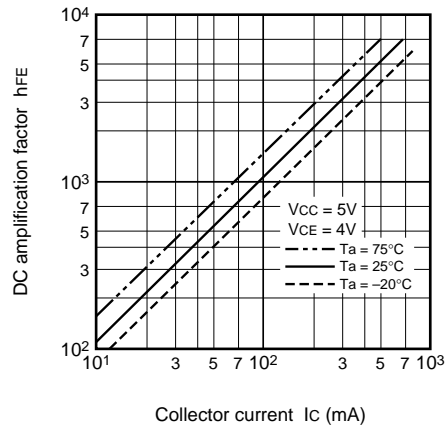

Input Characteristics

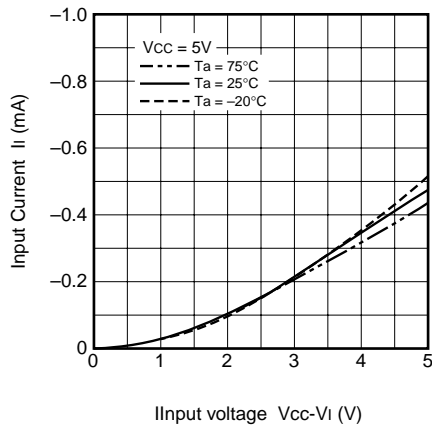

Driver Supply Characteristics

