

power light source

Luxeon™ Dental

Technical Data DS35

Luxeon™ is a revolutionary, energy efficient and ultra compact new light source, combining the lifetime and reliability advantages of Light Emitting Diodes with the brightness of conventional lighting.

Luxeon Dental Solutions include both Luxeon and Luxeon V alternatives, offering both a low and high power-curing source. Luxeon Dental is available in either the emitter or star form, allowing flexibility in curing system design.

Luxeon Dental products are selected from the peak wavelength range most effective for short curing times, and are produced to elevated minimum power levels to deliver the powerful short wavelength blue power required to reduce curing times while enabling handheld curing wands.

This revolutionary new product line is specifically tailored to the dental curing industry to provide the source most effective for this application.



Luxeon Dental is available in radiometric dental blue.

Features

- Highest Flux per LED in the world
- Very long operating life (up to 100k hours)
- More Energy Efficient than Incandescent and most Halogen lamps
- Low voltage DC operated
- Cool beam, safe to the touch
- Instant light (less than 100 ns)
- Fully dimmable
- No UV
- Superior ESD protection

Benefits

- Radiometric power levels and peak wavelength specifications matched to the response curves of many dental resins.
- Extreme radiometric power results in short curing times, <10 seconds for the Luxeon devices and on the order of 5 seconds for the Luxeon V devices.
- Low voltage DC operation allows for handheld cordless curing wand designs.
- Directed light from the source of the desired wavelength eliminates the need for inefficient color filters.
- Long life eliminates the need for bulb replacement



Mechanical Dimensions - Emitter

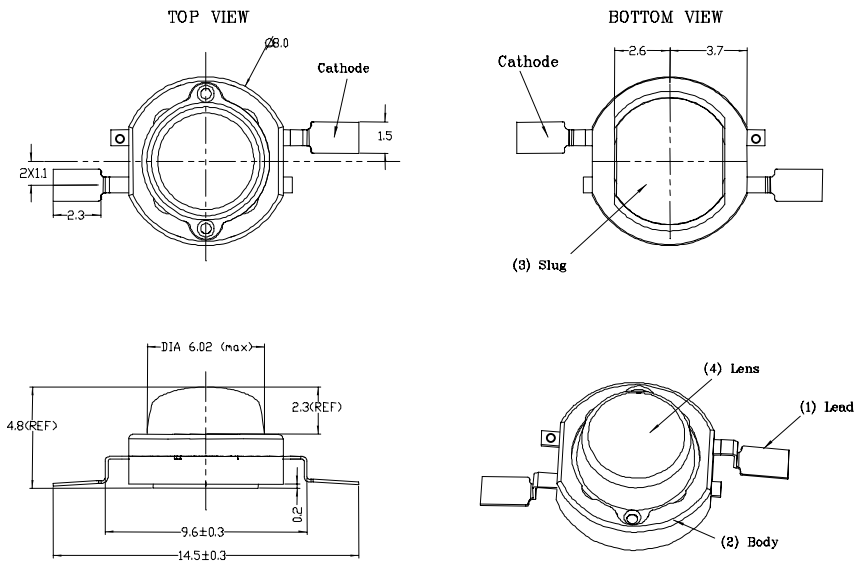

Batwing (Low Dome) – LXHL-BRD1

Notes:

1. The anode side of the device is denoted by a hole in the lead frame. Electrical insulation between the case and the board is required – slug of device is not electrically neutral. Do not electrically connect either the anode or cathode to the slug.
2. Drawings not to scale.
3. All dimensions are in millimeters.
4. All dimensions without tolerances are for reference only.

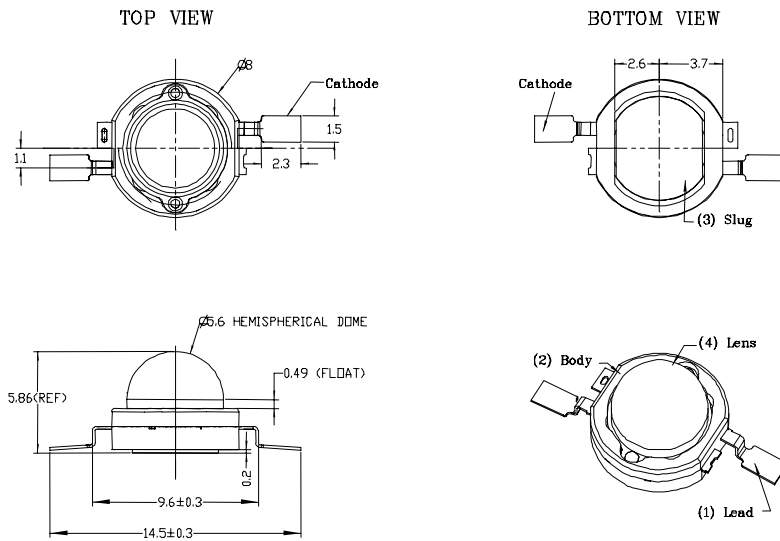

Lambertian (High Dome) – LXHL-PRD5

Notes:

1. The anode side of the device is denoted by a hole in the lead frame. Electrical insulation between the case and the board is required – slug of device is not electrically neutral. Do not electrically connect either the anode or cathode to the slug.
2. Drawings not to scale.
3. All dimensions are in millimeters.
4. All dimensions without tolerances are for reference only.

Mechanical Dimensions - Star

Luxeon Star

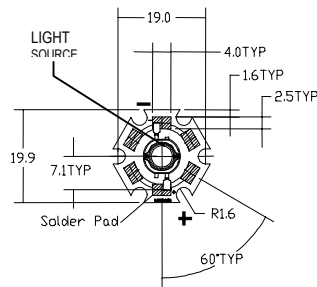

Batwing (Low Dome)

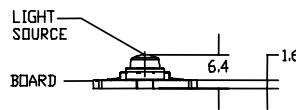

LXHL-MRD1

Notes:

1. Slots in aluminum-core PCB for M3 or #4 mounting screw.
2. Electrical interconnection pads labeled on the aluminum-core PCB with "+" and "-" to denote positive and negative, respectively. All positive pads are interconnected, as are all negative pads, allowing for flexibility in array interconnection.
3. Drawings not to scale.
4. All dimensions are in millimeters.

Luxeon V Star

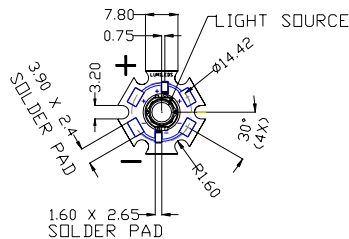

Lambertian

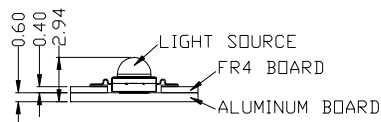

LXHL-LRD5

Notes:

1. Slots in aluminum-core PCB for M3 or #4 mounting screw.
2. Electrical interconnection pads labeled on the aluminum-core PCB with "+" and "-" to denote positive and negative, respectively. All positive pads are interconnected, as are all negative pads, allowing for flexibility in array interconnection.
3. Electrical insulation between neighboring Stars is required – aluminum board is not electrically neutral.
4. Drawings not to scale.
5. All dimensions are in millimeters.

Part Number Matrix

PART NUMBER	BEAM PATTERN	CONFIGURATION	PRODUCT TYPE	DRIVE CURRENT
LXHL-BRD I	BATWING	EMITTER	LUXEON	350 mA
LXHL-MRD I	BATWING	STAR	LUXEON	350 mA
LXHL-PRD5	LAMBERTIAN	EMITTER	LUXEON V	700 mA
LXHL-LRD5	LAMBERTIAN	STAR	LUXEON V	700 mA

Radiometric Power Characteristics at 350mA, Junction Temperature, $T_j = 25^\circ\text{C}$

LUXEON	CONFIGURATION	RADIATION PATTERN	MINIMUM RADIOMETRIC POWER (mW) $\Phi_V^{[1,2]}$	TYPICAL RADIOMETRIC POWER (mW) $\Phi_V^{[2]}$
LXHL-BRD I	EMITTER	BATWING	115	140
LXHL-MRD I	STAR	BATWING	115	140

Notes (for both power tables):

1. Minimum radiometric power performance guaranteed within published operating conditions. Lumileds maintains a tolerance of $\pm 10\%$ on power measurements.
2. Luxeon types with even higher radiometric power levels will become available in the future. Please consult your Lumileds Authorized Distributor or Lumileds sales representative for more information.

Radiometric Power Characteristics at 700mA, Junction Temperature, $T_j = 25^\circ\text{C}$, Continued

LUXEON V	CONFIGURATION	RADIATION PATTERN	MINIMUM RADIOMETRIC POWER (mW) $\Phi_V^{[1,2]}$	TYPICAL RADIOMETRIC POWER (mW) $\Phi_V^{[2]}$
LXHL-PRD5	EMITTER	LAMBERTIAN	500	600
LXHL-LRD5	STAR	LAMBERTIAN	500	600

Optical Characteristics at 350 or 700mA, Junction Temperature, $T_j = 25^\circ\text{C}$

PART NUMBER	PEAK WAVELENGTH ^[3] λ_P			SPECTRAL HALF-WIDTH ^[4] (nm) $\Delta\lambda_{1/2}$	TEMP COEFFICIENT OF DOMINANT WAVELENGTH (nm/ $^\circ\text{C}$) $\Delta\lambda_0/\Delta T_j$	TOTAL INCLUDED ANGLE ^[5] (DEGREES) $\theta_{0.90V}$	VIEWING ANGLE ^[6] (DEGREES) $2\theta_{1/2}$
	MIN.	TYP.	MAX.				
LXHL-BRD I ^[11]	450	460	470	20	0.04	110	110
LXHL-MRD I ^[11]	450	460	470	20	0.04	110	110
LXHL-PRD5 ^[2]	450	460	470	20	0.04	150	150
LXHL-LRD5 ^[2]	450	460	470	20	0.04	150	150

Notes:

1. Rated driver current of 350 mA for Luxeon Dental products.
2. Rated drive current of 700 mA for Luxeon V Dental products.
3. Lumileds maintains a tolerance of $\pm 2\text{nm}$ for peak wavelength measurements.
4. Spectral width at $1/2$ of the peak intensity.
5. Total angle at which 90% of total luminous flux is captured.
6. $\theta_{1/2}$ is the off axis angle from lamp centerline where the luminous intensity is $1/2$ of the peak value.
7. All products built with Indium Gallium Nitride (InGaN).
8. All power light sources represented here are IEC825 Class 2 for eye safety.

Electrical Characteristics at 350 or 700mA, Junction Temperature, $T_J = 25^\circ\text{C}$

PART NUMBER	FORWARD VOLTAGE V_F (V) ⁽³⁾			DYNAMIC RESISTANCE ⁽⁴⁾ (Ω) R_D	TEMPERATURE COEFFICIENT OF FORWARD VOLTAGE ⁽⁵⁾ (mV/ $^\circ\text{C}$) $\Delta V_F / \Delta T_J$	THERMAL RESISTANCE, JUNCTION TO SLUG OR CASE ⁽⁶⁾ ($^\circ\text{C/W}$) $R_{\theta_{JC}}$
	MIN.	TYP.	MAX.			
LXHL-BRD I ⁽¹⁾	2.79	3.42	3.99	1.0	-2.0	15
LXHL-MRD I ⁽¹⁾	2.79	3.42	3.99	1.0	-2.0	20
LXHL-PRD5 ⁽²⁾	5.43	6.84	7.83	1.0	-4.0	8
LXHL-LRD5 ⁽²⁾	5.43	6.84	7.83	1.0	-4.0	11

Notes:

1. Rated drive current of 350 mA for Luxeon Dental products.
2. Rated drive current of 700 mA for Luxeon V Dental products.
3. Lumileds maintains a tolerance of $\pm 0.06\text{V}$ on forward voltage measurements.
4. Dynamic resistance is the inverse of the slope in linear forward voltage model for LEDs. See Figures 3a and 3b.
5. Measured between $25^\circ\text{C} \leq T_J \leq 110^\circ\text{C}$ at $I_F = 350$ or 700mA .
6. Thermal resistance junction to slug for emitter products, junction to board for star products.

Absolute Maximum Ratings

PARAMETER	LXHL-BRD I LXHL-MRD I	LXHL-PRD5 LXHL-LRD5
DC FORWARD CURRENT (mA) ⁽¹⁾	350	700
PEAK PULSED FORWARD CURRENT (mA)	500	1000
AVERAGE FORWARD CURRENT (mA)	350	700
ESD SENSITIVITY ⁽²⁾	$\pm 16,000\text{V HBM}$	
LED JUNCTION TEMPERATURE ($^\circ\text{C}$)	135	135
EMITTER STORAGE TEMPERATURE ($^\circ\text{C}$)	-40 to +120	-40 to +120
EMITTER SOLDERING TEMPERATURE ($^\circ\text{C}$) ⁽³⁾	260 FOR 5 SECONDS MAX	260 FOR 5 SECONDS MAX
STAR ALUMINUM-CORE PCB TEMPERATURE ($^\circ\text{C}$)	105 ⁽⁴⁾	70 ⁽⁴⁾
STAR STORAGE TEMPERATURE ($^\circ\text{C}$)	-40 to +105	-40 to +105

Notes:

1. Proper current derating must be observed to maintain junction temperature below the maximum. For more information, consult the Luxeon Design Guide, available upon request.
2. LEDs are not designed to be driven in reverse bias. Please consult Lumileds' Application Brief AB11 for further information.
3. Measured at leads, during lead soldering and slug attach, body temperature must not exceed 120°C . Luxeon emitters cannot be soldered by general IR or Vapor-phase reflow, nor by wave soldering. Lead soldering is limited to selective heating of the leads, such as by hot-bar reflow, fiber focussed IR, or hand soldering. The package back plane (slug) may not be attached by soldering, but rather with a thermally conductive adhesive. Electrical insulation between the slug and the board is required. Please consult Lumileds' Application Brief AB10 on Luxeon Emitter Assembly Information for further details on assembly methods.
4. Allowable MCPCB temperature to avoid exceeding maximum junction temperature at maximum V_f limit at rated DC forward current based on thermal resistance of Star assembly.

Wavelength Characteristics, $T_J = 25^\circ\text{C}$

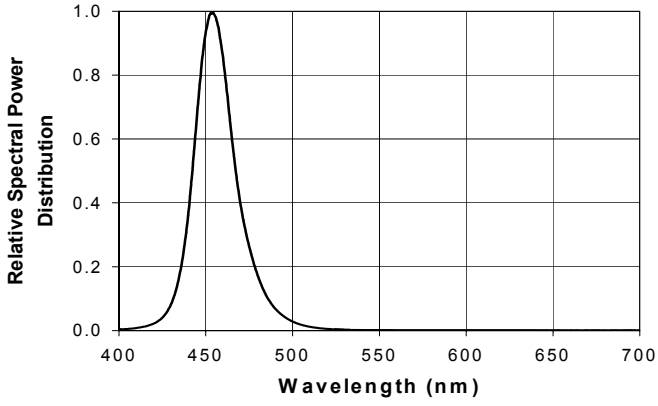

Figure 1.
Relative Intensity vs. Wavelength.

Light Output Characteristics

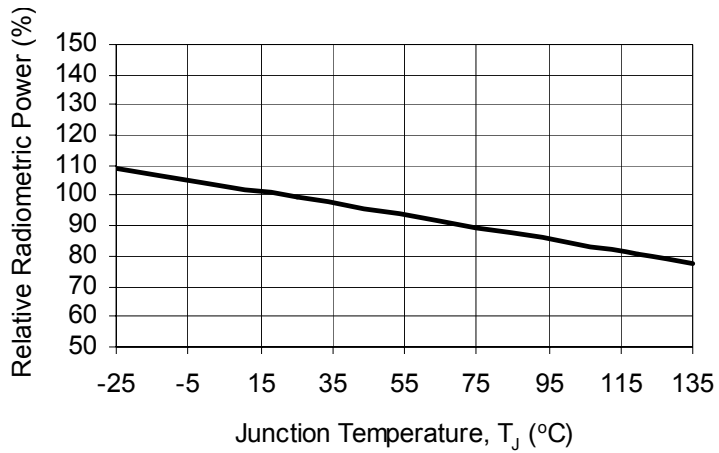

Figure 2.
Relative Radiometric Power vs. Junction Temperature

Forward Current Characteristics, $T_J = 25^\circ\text{C}$

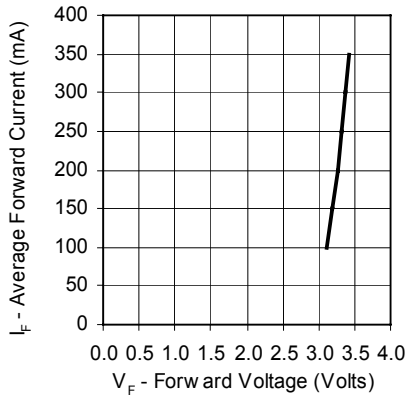

Figure 3a.
Forward Current vs. Forward Voltage for LXHL-BRD1 and LXHL-MRD1

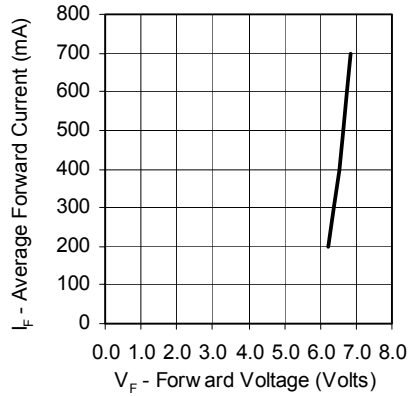

Figure 3b.
Forward Current vs. Forward Voltage for LXHL-PRD5 and LXHL-LRD5

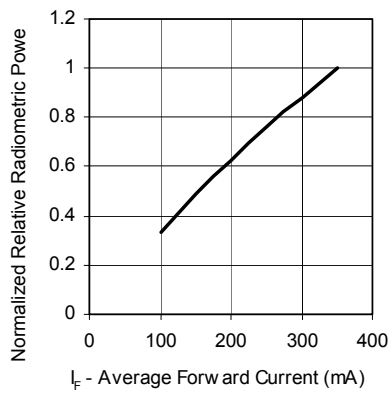

Figure 4a.
Relative Luminous Flux vs. Forward Current for LXHL-BRD1 and LXHL-MRD1 at $T_J = 25^\circ\text{C}$ maintained.

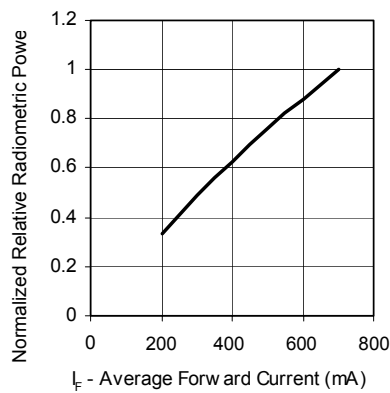

Figure 4b.
Relative Luminous Flux vs. Forward Current for LXHL-PRD5 and LXHL-LRD5 at $T_J = 25^\circ\text{C}$ maintained.

Note:

Driving these high power devices at currents less than the test conditions may produce unpredictable results and may be subject to variation in performance. Pulse width modulation (PWM) is recommended for dimming effects.

Current Derating Curves – Luxeon

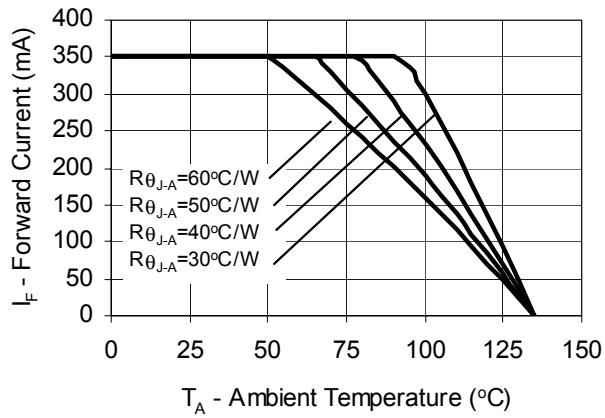

Figure 5.
Maximum Forward Current vs. Ambient Temperature. Derating based on $T_{JMAX} = 135^\circ\text{C}$ for LXHL-BRD1 and LXHL-MRD1.

Current Derating Curves – Luxeon V

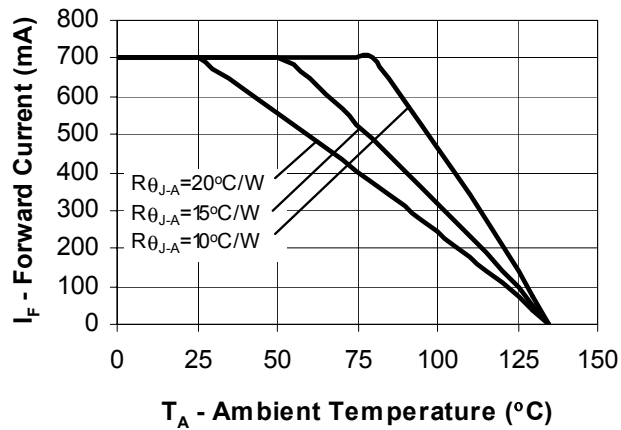

Figure 6.
Maximum Forward Current vs. Ambient Temperature. Derating based on $T_{JMAX} = 135^\circ\text{C}$ for LXHL-PRD5 and LXHL-LRD5.

Representative Spatial Radiation Pattern

Note:

For more detailed technical information regarding Luxeon radiation patterns, please consult your Lumileds Authorized Distributor or Lumileds sales representative.

Batwing Radiation Pattern

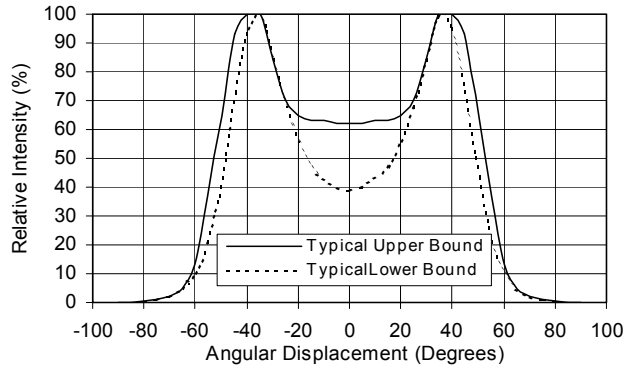

Figure 7.
Representative Spatial Radiation Pattern for LXHL-BRD1 and LXHL-MRD1

Lambertian Radiation Pattern

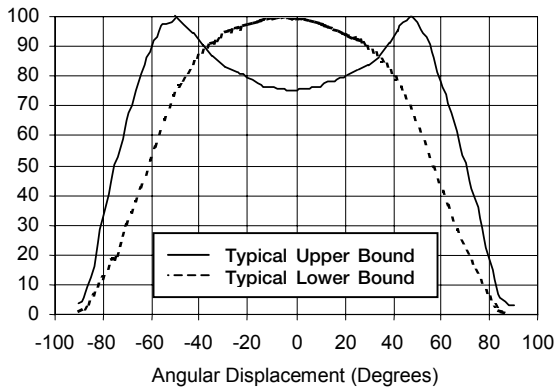

Figure 8.
Representative Spatial Radiation Pattern for LXHL-PRD5 and LXHL-LRD5

Emitter Reel Packaging

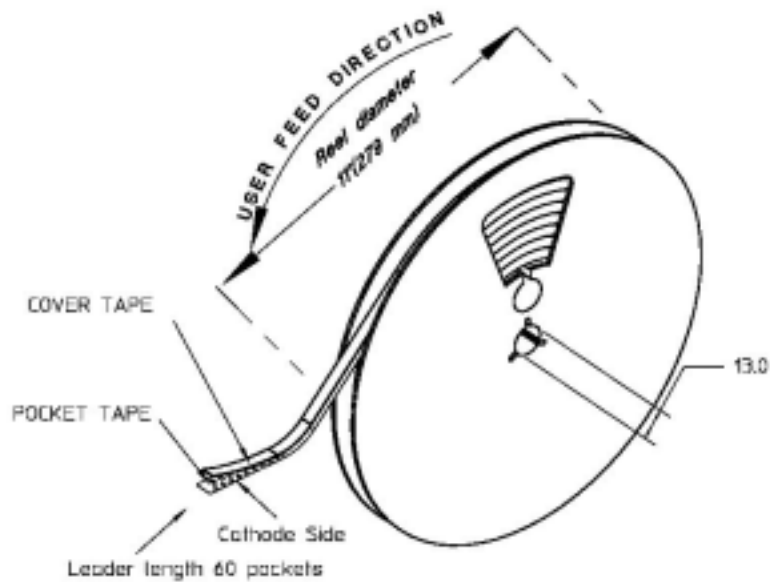

Figure 9.
Reel dimensions and orientation.

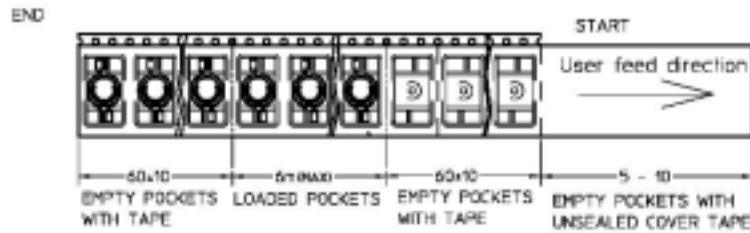
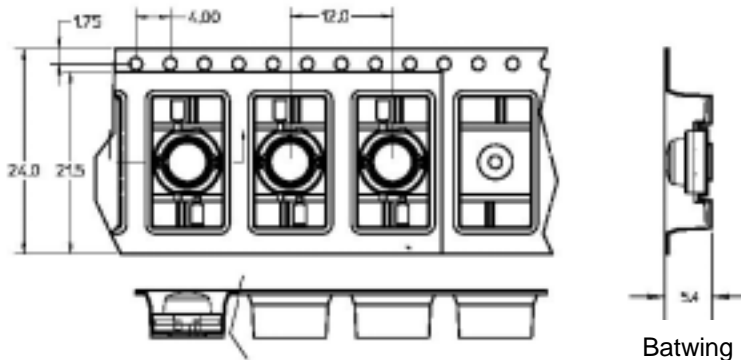

Figure 10.
Tape dimensions for Batwing radiation pattern.



Notes:

1. Luxeon emitters should be picked up by the body (not the lens) during placement. The inner diameter of the pick-up collet should be greater than or equal to 6.5 mm. Please consult Lumileds' Application Brief AB10 on Luxeon Emitter assembly information for further details on assembly methods.
2. Drawings not to scale.
3. All dimensions are in millimeters.
4. All dimensions without tolerances are for reference only.

Emitter Reel Packaging

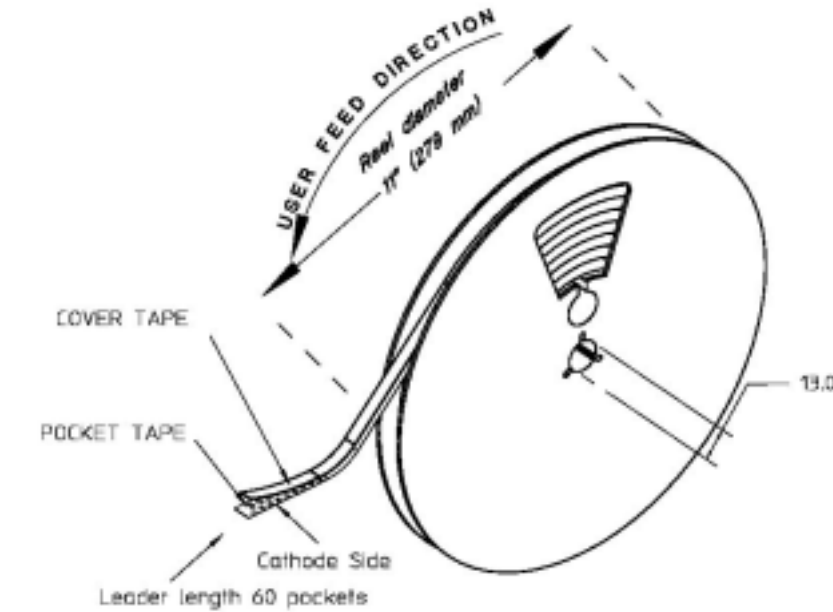

Figure 11.
Reel dimensions and orientation.

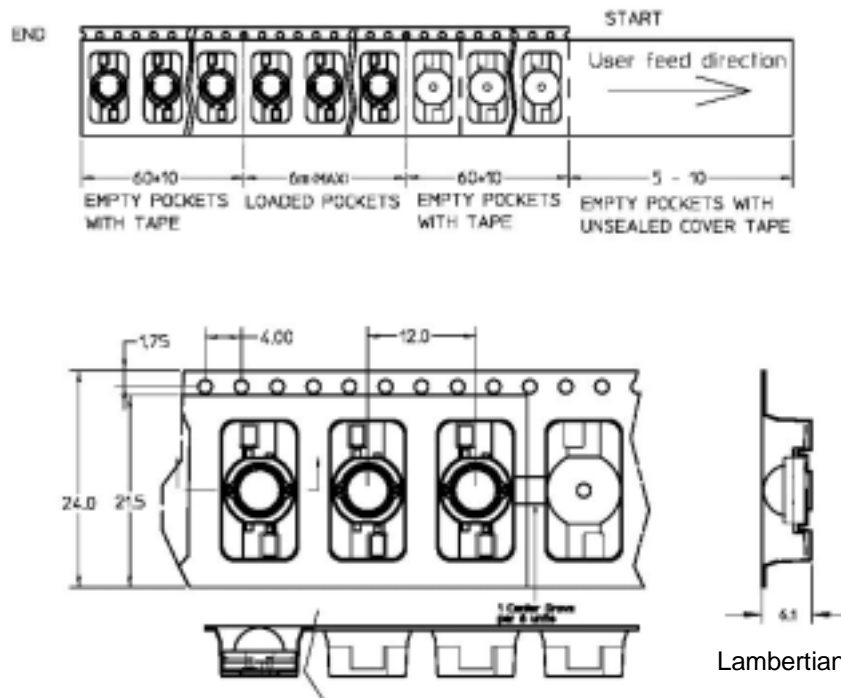

Figure 12.
Tape dimensions for Lambertian radiation pattern.

Notes:

1. Luxeon emitters should be picked up by the body (not the lens) during placement. The inner diameter of the pick-up collet should be greater than or equal to 6.5 mm. Please consult Lumileds' Application Brief AB10 on Luxeon Emitter assembly information for further details on assembly methods.
2. Drawings not to scale.
3. All dimensions are in millimeters.
4. All dimensions without tolerances are for reference only.

About Luxeon



Luxeon is the new world of solid state lighting (LED) technology. Luxeon Power Light Source Solutions offer huge advantages over conventional lighting and huge advantages over other LED solutions. Luxeon enables partners to create and market products that, until now, were impossible to create. This means the opportunity to create products with a clear competitive advantage in the market. Products that are smaller, lighter, sleeker, cooler, and brighter. Products that are more fun to use, more efficient, and more environmentally conscious than ever before possible!



Company Information

Luxeon is developed, manufactured and marketed by Lumileds Lighting, LLC. Lumileds is a world-class supplier of Light Emitting Diodes (LEDs) producing billions of LEDs annually. Lumileds is a fully integrated supplier, producing core LED material in all three base colors (Red, Green, Blue) and White. Lumileds has R&D development centers in San Jose, California and Best, The Netherlands. Production capabilities in San Jose, California and Malaysia.

Lumileds is pioneering the high-flux LED technology and bridging the gap between solid state LED technology and the lighting world. Lumileds is absolutely dedicated to bringing the best and brightest LED technology to enable new applications and markets in the Lighting world.



©2003 Lumileds Lighting. All rights reserved. Luxeon is a trademark of Lumileds Lighting, U.S., LLC. Product specifications are subject to change without notice.

Lumileds may make process or materials changes affecting the performance or other characteristics of Luxeon. These products supplied after such change will continue to meet published specifications, but may not be identical to products supplied as samples or under prior orders.

LUMILEDS

www.luxeon.com
www.lumileds.com

For technical assistance or the location of your nearest Lumileds sales office, call:

Worldwide:
+1 408-435-6044
US Toll free: 877-298-9455
Europe: +31 499 339 439
Asia: +65 6248 4759
Fax: 408-435-6855
Email us at info@lumileds.com

Lumileds Lighting U.S., LLC
370 West Trimble Road
San Jose, CA 95131