

FS50SM-3

HIGH-SPEED SWITCHING USE

FS50SM-3



- 10V DRIVE
- V_{DSS} 150V
- r_{DS (ON)} (MAX) 31mΩ
- I_D 50A
- Integrated Fast Recovery Diode (TYP.) 130ns

OUTLINE DRAWING

Dimensions in mm

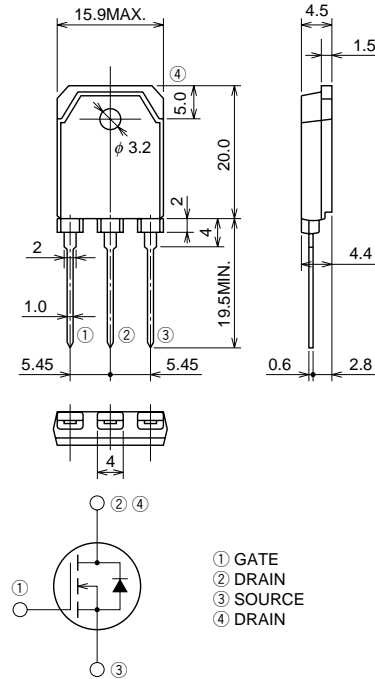

TO-3P

APPLICATION

Motor control, Lamp control, Solenoid control
DC-DC converter, etc.

MAXIMUM RATINGS (T_c = 25°C)

Symbol	Parameter	Conditions	Ratings	Unit
V _{DSS}	Drain-source voltage	V _{GS} = 0V	150	V
V _{GSS}	Gate-source voltage	V _{DS} = 0V	±20	V
I _D	Drain current		50	A
I _{DM}	Drain current (Pulsed)		200	A
I _{DA}	Avalanche drain current (Pulsed)	L = 100μH	50	A
I _S	Source current		50	A
I _{SM}	Source current (Pulsed)		200	A
P _D	Maximum power dissipation		150	W
T _{ch}	Channel temperature		-55 ~ +150	°C
T _{stg}	Storage temperature		-55 ~ +150	°C
—	Weight	Typical value	4.8	g

ELECTRICAL CHARACTERISTICS (Tch = 25°C)

Symbol	Parameter	Test conditions	Limits			Unit
			Min.	Typ.	Max.	
V(BR)DSS	Drain-source breakdown voltage	Id = 1mA, VGS = 0V	150	—	—	V
IGSS	Gate-source leakage current	VGS = ±20V, VDS = 0V	—	—	±0.1	μA
IDSS	Drain-source leakage current	VDS = 150V, VGS = 0V	—	—	0.1	mA
VGS(th)	Gate-source threshold voltage	Id = 1mA, VDS = 10V	2.0	3.0	4.0	V
rDS(ON)	Drain-source on-state resistance	Id = 25A, VGS = 10V	—	24	31	mΩ
VDS(ON)	Drain-source on-state voltage	Id = 25A, VGS = 10V	—	0.600	0.775	V
yfs	Forward transfer admittance	Id = 25A, VDS = 10V	—	55	—	S
Ciss	Input capacitance	VDS = 10V, VGS = 0V, f = 1MHz	—	6540	—	pF
Coss	Output capacitance		—	860	—	pF
Crss	Reverse transfer capacitance		—	360	—	pF
td(on)	Turn-on delay time	VDD = 80V, Id = 25A, VGS = 10V, RGEN = RGS = 50Ω	—	95	—	ns
tr	Rise time		—	155	—	ns
td(off)	Turn-off delay time		—	380	—	ns
tf	Fall time		—	180	—	ns
VSD	Source-drain voltage	IS = 25A, VGS = 0V	—	1.0	1.5	V
Rth(ch-c)	Thermal resistance	Channel to case	—	—	0.83	°C/W
trr	Reverse recovery time	IS = 50A, dis/dt = -100A/μs	—	130	—	ns

PERFORMANCE CURVES

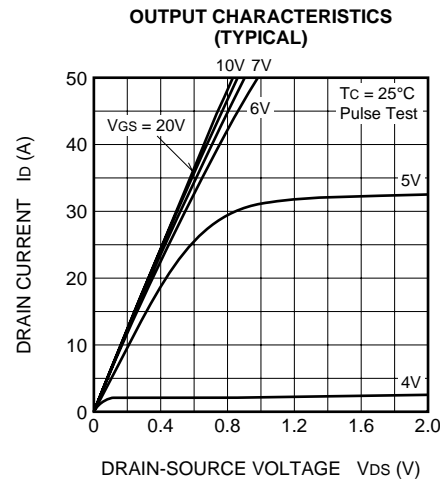
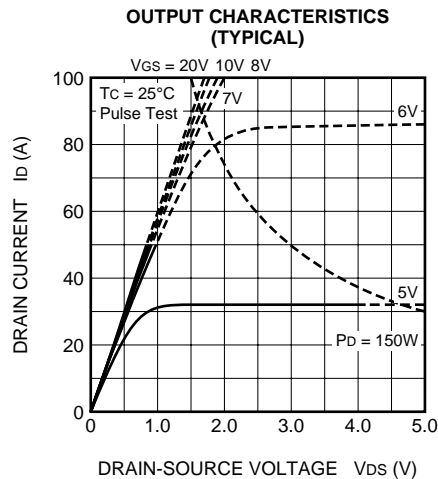
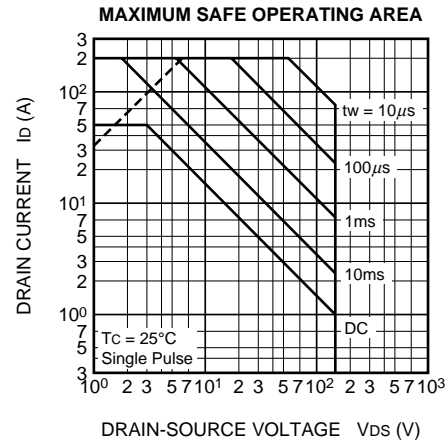
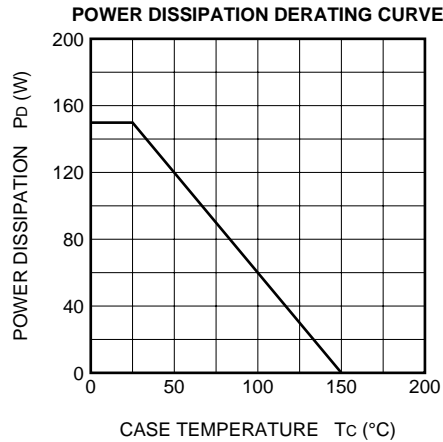

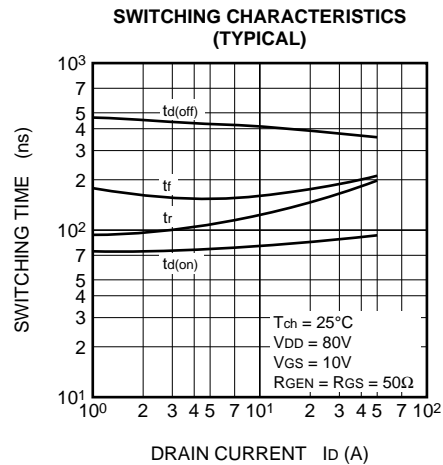
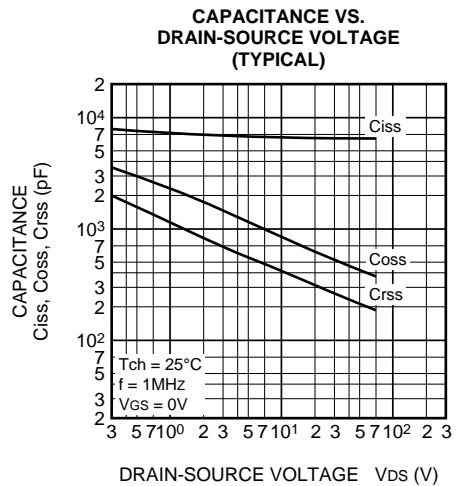
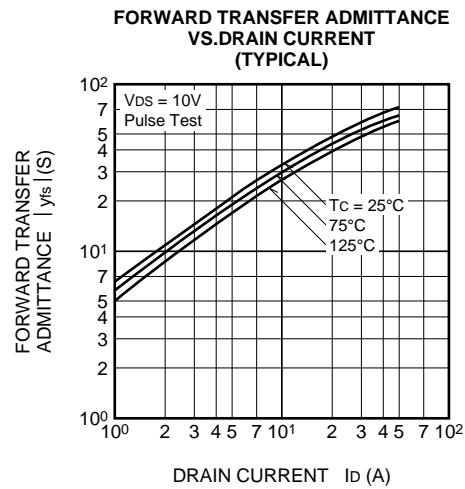
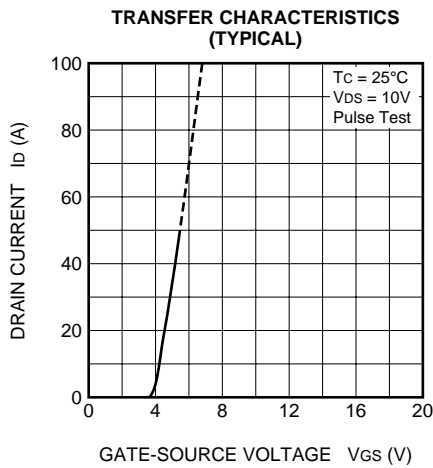
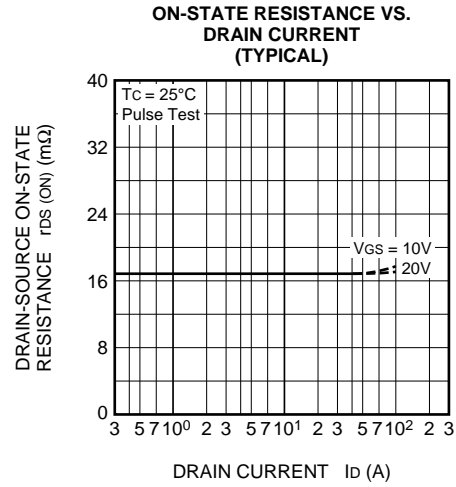
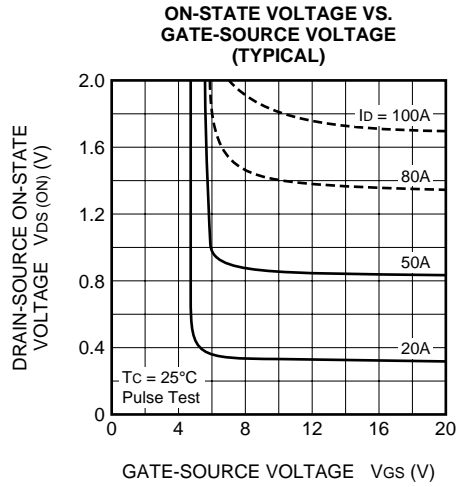

GATE-SOURCE VOLTAGE VS. GATE CHARGE (TYPICAL)

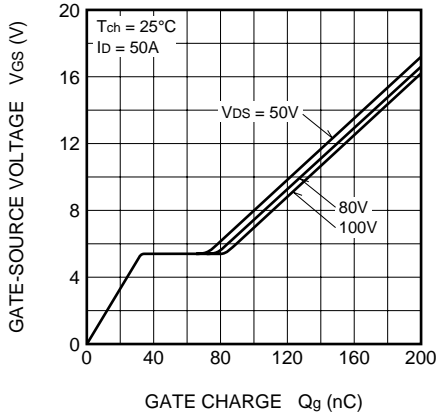

SOURCE-DRAIN DIODE FORWARD CHARACTERISTICS (TYPICAL)

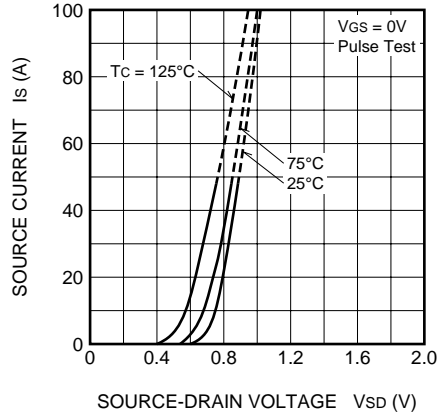

ON-STATE RESISTANCE VS. CHANNEL TEMPERATURE (TYPICAL)

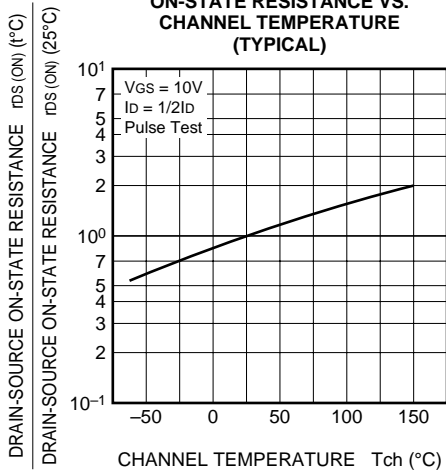

THRESHOLD VOLTAGE VS. CHANNEL TEMPERATURE (TYPICAL)

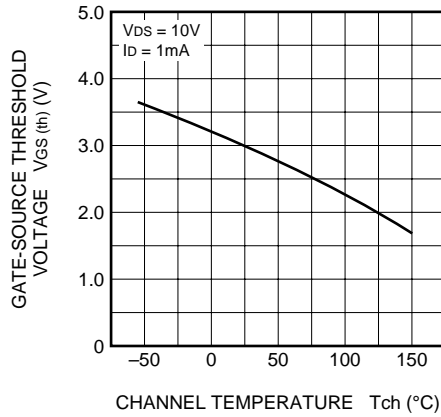

BREAKDOWN VOLTAGE VS. CHANNEL TEMPERATURE (TYPICAL)

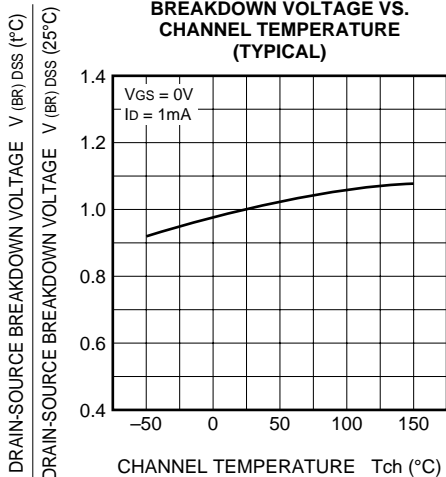

TRANSIENT THERMAL IMPEDANCE CHARACTERISTICS

