

## Source and Sink, 1.5A, Fast Transient Response Linear Regulator

### Features

- **Provide Bi-direction Output Currents**  
-Sourcing and Sinking Current up to 1.5A
- **Built-in Soft-Start**
- **Power-On-Reset Monitoring on VCNTL and VIN pins**
- **Fast Transient Response**
- **Stable with Ceramic Output Capacitors**
- **±20mV High System Output Accuracy over Load and Temperature Ranges**
- **Adjustable Output Voltage by External Resistors**
- **Current-Limit Protection**
- **On-Chip Thermal Shutdown**
- **Shutdown for Standby or Suspend Mode**
- **Simple SOP-8 and SOP-8 with Exposed Pad (SOP-8P) Packages**
- **Lead Free and Green Devices Available (RoHS Compliant)**

### Applications

- **DDRII/III SDRAM Termination Voltage**
- **Motherboard and VGA Card Power Supplies**
- **Setop Box**
- **SSTL-2/3 Termination Voltage**

### Simplified Application Circuit

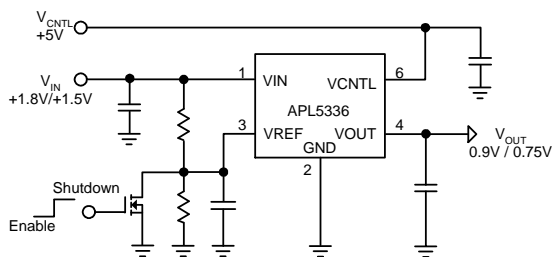

### General Description

The APL5336 linear regulator is designed to provide a regulated voltage with bi-direction output current for DDR-SDRAM termination voltage. The APL5336 integrates two power transistors to source or sink load current up to 1.5A. It also features internal soft-start, current-limit, thermal shutdown and enable control functions into a single chip.

The internal soft-start controls the rising rate of the output voltage to prevent inrush current during start-up. The current-limit circuit detects the output current and limits the current during short-circuit or current overload conditions. The on-chip thermal shutdown provides thermal protection against any combination of overload that would create excessive junction temperatures.

The output voltage of APL5336 is regulated to track the voltage on VREF pin. A proper resistor divider connected to VIN, GND, and VREF pins is used to provide a half voltage of VIN to VREF pin. In addition, connect an external ceramic capacitor and an open-drain transistor to VREF pin for external soft-start and shutdown control.

Pulling and holding the voltage on VREF below the enable voltage threshold shuts down the output. The output of APL5336 will be high impedance after being shut down by VREF or the thermal shutdown function.

### Pin Configuration

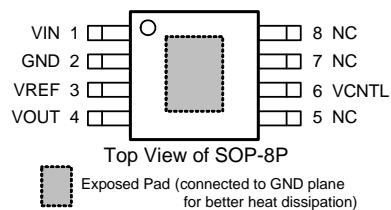
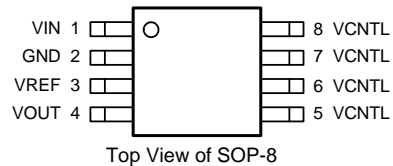

ANPEC reserves the right to make changes to improve reliability or manufacturability without notice, and advise customers to obtain the latest version of relevant information to verify before placing orders.

**Ordering and Marking Information**

<p>APL5336 □□□-□□□</p> <p>Assembly Material Handling Code Temperature Range Package Code</p>	<p>Package Code K : SOP-8      KA : SOP-8P Operating Ambient Temperature Range I : -40 to 85°C Handling Code TR : Tape &amp; Reel Assembly Material L : Lead Free Device    G : Halogen and Lead Free Device</p>
<p>APL5336 K: <span style="border: 1px solid black; padding: 2px;">APL5336 XXXXX</span>      APL5336 KA: <span style="border: 1px solid black; padding: 2px;">APL5336 XXXXX</span>      XXXXX - Date Code</p>	

Note: ANPEC lead-free products contain molding compounds/die attach materials and 100% matte tin plate termination finish; which are fully compliant with RoHS. ANPEC lead-free products meet or exceed the lead-free requirements of IPC/JEDEC J-STD-020C for MSL classification at lead-free peak reflow temperature. ANPEC defines "Green" to mean lead-free (RoHS compliant) and halogen free (Br or Cl does not exceed 900ppm by weight in homogeneous material and total of Br and Cl does not exceed 1500ppm by weight).

**Absolute Maximum Ratings** (Note 1)

Symbol	Parameter	Rating	Unit
V <sub>CNTL</sub>	VCNTL Supply Voltage (VCNTL to GND)	-0.3 ~ 7	V
V <sub>IN</sub>	VIN Supply Voltage (VIN to GND)	-0.3 ~ 7	V
V <sub>REF</sub>	VREF Input Voltage (VREF to GND)	-0.3 ~ 7	V
V <sub>OUT</sub>	VOUT Output Voltage (VOUT to GND)	-0.3 ~ V <sub>IN</sub> +0.3V	V
P <sub>D</sub>	Power Dissipation	Internally Limited	W
T <sub>J</sub>	Junction Temperature	150	°C
T <sub>STG</sub>	Storage Temperature Range	-65 ~ 150	°C
T <sub>SDR</sub>	Maximum Lead Soldering Temperature, 10 Seconds	260	°C

Note 1: Stresses above those listed in "Absolute Maximum Ratings" may cause permanent damage to the device.

**Thermal Characteristics**

Symbol	Parameter	Rating	Unit
θ <sub>JA</sub>	Junction-to-Ambient Thermal Resistance in Free Air <sup>(Note 2)</sup>		
	SOP-8	80	°C/W
	SOP-8P	55	
θ <sub>JC</sub>	Junction-to-Case Thermal Resistance in Free Air <sup>(Note 3)</sup>		°C/W
	SOP-8P	20	

Note 2: θ<sub>JA</sub> is measured with the component mounted on a high effective thermal conductivity test board in free air.

Note 3: The exposed pad of SOP-8P is soldered directly on the PCB. The case temperature is measured at the center of the exposed pad on the underside of the SOP-8P package.

**Recommended Operating Conditions**

Symbol	Parameter	Range	Unit
V <sub>CNTL</sub>	VCNTL Supply Voltage	3.0 ~ 5.5	V
V <sub>IN</sub>	VIN Supply Voltage	1.2 ~ 5.5	V
V <sub>REF</sub>	VREF Input Voltage	0.7 ~ V <sub>CNTL</sub> - 2.2	V
V <sub>OUT</sub>	VOUT Output Voltage	V <sub>REF</sub> ± 0.02	V

### Recommended Operating Conditions (Cont.)

Symbol	Parameter	Range	Unit
$I_{OUT}$	VOUT Output Current <sup>(Note 4)</sup>	-1.5 ~ +1.5	A
$C_{IN}$	Capacitance of Input Capacitor	10 ~ 100	$\mu F$
	Equivalent Series Resistor (ESR) of Input Capacitor	0 ~ 200	$m\Omega$
$C_{OUT}$	Capacitance of Output Multi-layer Ceramic Capacitor (MLCC)	8 ~ 47	$\mu F$
	Total Output Capacitance <sup>(Note 5)</sup>	10 ~ 330	$\mu F$
$T_A$	Ambient Temperature	-40 ~ 85	$^{\circ}C$
$T_J$	Junction Temperature	-40 ~ 125	$^{\circ}C$

Note 4: The symbol “+” means the VOUT sources current to load; the symbol “-” means the VOUT sinks current from load to GND.

Note 5: It's necessary to use a multi-layer ceramic capacitor 8 $\mu F$  at least as an output capacitor. **Please place the ceramic capacitor near VOUT pin as close as possible.** Besides, the other kinds of capacitors (like Electrolytic, PoSCap, tantalum capacitors) can be used as the output capacitors in parallel.

### Electrical Characteristics

Refer to the typical application circuit. These specifications apply over  $V_{CNTL}=5V$ ,  $V_{IN}=1.8V$  or  $1.5V$ ,  $V_{REF}=0.5V_{IN}$ ,  $C_{IN}=10\mu F$ ,  $C_{OUT}=10\mu F$  (MLCC) and  $T_A=-40\sim 85^{\circ}C$ , unless otherwise specified. Typical values are at  $T_A=25^{\circ}C$ .

Symbol	Parameter	Test Conditions	APL5336			Unit
			Min	Typ	Max	
<b>SUPPLY CURRENT</b>						
$I_{CNTL}$	VCNTL Supply Current	$I_{OUT}=0A$	-	1	2	mA
		$V_{REF}=0V$ (Shutdown)	-	-	5	$\mu A$
$I_{VIN}$	VIN Supply Current at Shutdown	$V_{REF} = GND$ (Shutdown)	-	-	5	$\mu A$
<b>POWER-ON-RESET (POR)</b>						
	Rising VCNTL POR Threshold	$V_{CNTL}$ Rising	2.5	2.75	2.9	V
	VCNTL POR Hysteresis		-	0.35	-	V
	Rising VIN POR Threshold	$V_{IN}$ Rising	0.7	0.9	1.05	
	VIN POR Hysteresis		-	0.3	-	V
<b>OUTPUT VOLTAGE</b>						
$V_{OUT}$	VOUT Output Voltage	$I_{OUT}=0A$ , $V_{REF}=0.7V \sim 2.8V$	-	$V_{REF}$	-	V
	System Accuracy	Over temperature and load current ranges	-20	-	20	mV
$V_{OS}$	VOUT Offset Voltage ( $V_{OUT}-V_{REF}$ )	$I_{OUT}=+10mA$	-7	-1	-	mV
		$I_{OUT}=-10mA$	-	+8	+12	
	Load Regulation	$I_{OUT}=+10mA \sim +1.5A$	-13	-8	-	mV
		$I_{OUT}=-10mA \sim -1.5A$	-	+4	+8	

**Electrical Characteristics (Cont.)**

Refer to the typical application circuit. These specifications apply over  $V_{CNTL}=5V$ ,  $V_{IN}=1.8V$  or  $1.5V$ ,  $V_{REF}=0.5V_{IN}$ ,  $C_{IN}=10\mu F$ ,  $C_{OUT}=10\mu F$  (MLCC) and  $T_A=-40\sim 85^{\circ}C$ , unless otherwise specified. Typical values are at  $T_A=25^{\circ}C$ .

Symbol	Parameter	Test Conditions	APL5336			Unit	
			Min	Typ	Max		
<b>PROTECTIONS</b>							
$I_{LIM}$	Current-Limit	Sourcing Current ( $V_{IN}=1.8V$ )	$T_J=25^{\circ}C$	1.8	2	3	A
			$T_J=125^{\circ}C$	1.6	-	-	
		Sinking Current ( $V_{IN}=1.8V$ )	$T_J=25^{\circ}C$	-2	-2.2	-3	
			$T_J=125^{\circ}C$	-1.6	-	-	
		Sourcing Current ( $V_{IN}=1.5V$ )	$T_J=25^{\circ}C$	1.6	1.8	2.6	A
			$T_J=125^{\circ}C$	1.1	-	-	
Sinking Current ( $V_{IN}=1.5V$ )	$T_J=25^{\circ}C$	-1.6	-1.8	-2.6			
	$T_J=125^{\circ}C$	-1.1	-	-			
$T_{SD}$	Thermal Shutdown Temperature	$T_J$ rising	-	150	-	$^{\circ}C$	
	Thermal Shutdown Hysteresis		-	40	-		
<b>ENABLE and SOFT-START</b>							
	VREF Enable Voltage Threshold		0.15	0.3	0.4	V	
$I_{VREF}$	VREF Bias Current		-100	-	+100	nA	
$T_{SS}$	Soft-Start Interval		0.1	0.2	0.4	ms	

Typical Operating Characteristics

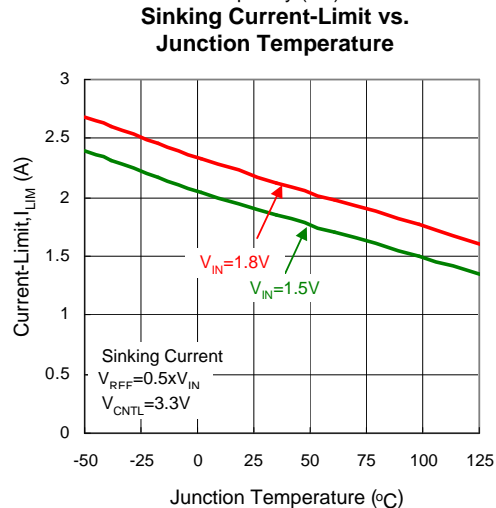
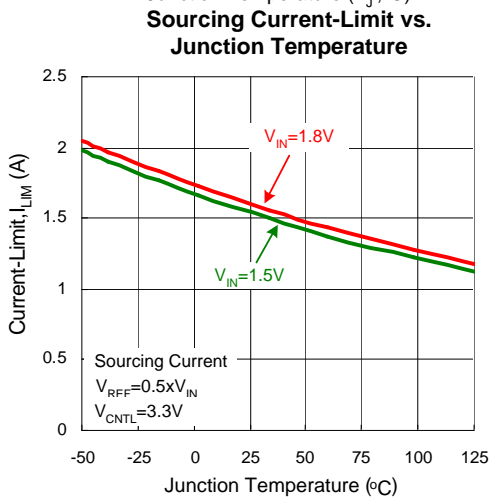
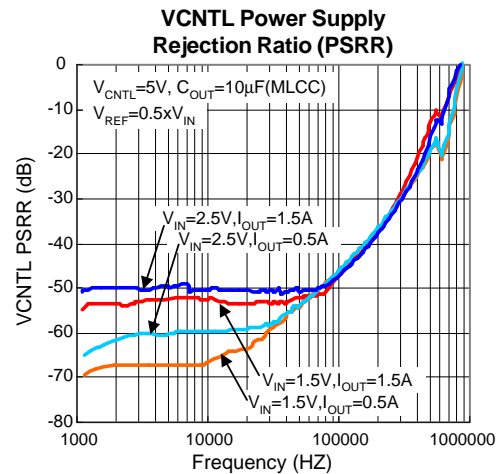
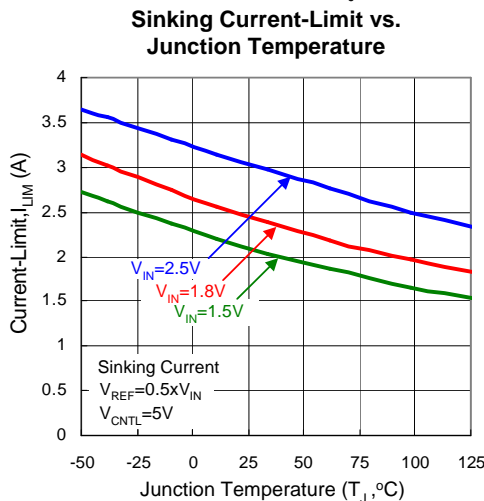
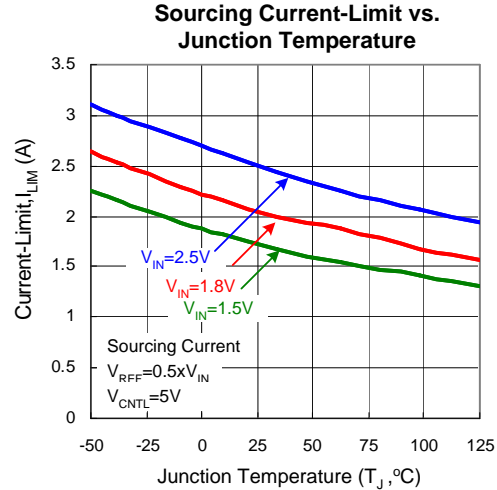
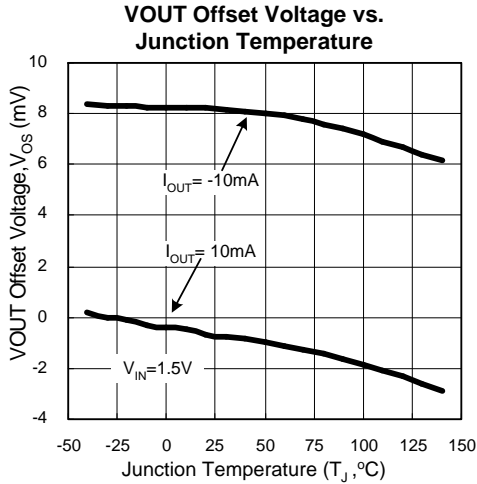

### Operating Waveforms

$V_{CNTL} = 5V$ ,  $V_{IN} = 1.8V$  or  $1.5V$ ,  $V_{REF} = 0.5 \times V_{IN}$ ,  $C_{IN} = C_{OUT} = 10\mu F$  (MLCC)

Load Transient Response ( $V_{IN} = 1.8V$ )

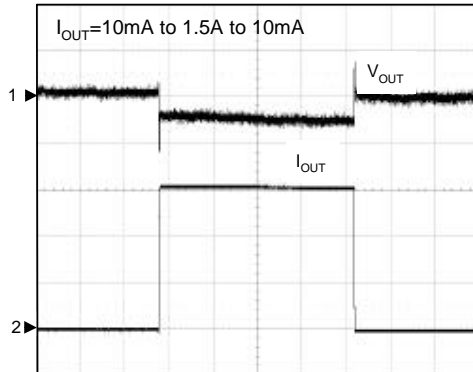

CH1:  $V_{OUT}$ , 20mV/Div, AC  
 CH2:  $I_{OUT}$ , 0.5A/Div, DC  
 TIME: 200µs/Div

Load Transient Response ( $V_{IN} = 1.8V$ )

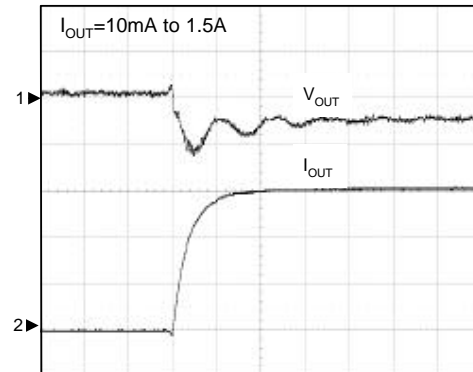

CH1:  $V_{OUT}$ , 20mV/Div, AC  
 CH2:  $I_{OUT}$ , 0.5A/Div, DC  
 TIME: 1µs/Div

Load Transient Response ( $V_{IN} = 1.8V$ )

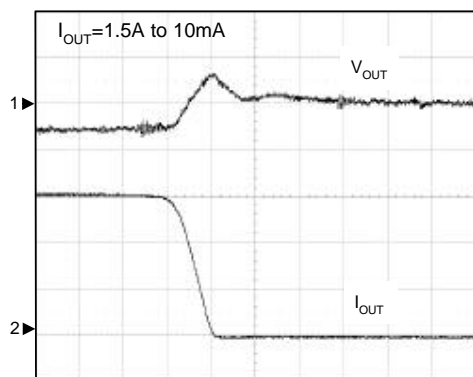

CH1:  $V_{OUT}$ , 20mV/Div, AC  
 CH2:  $I_{OUT}$ , 0.5A/Div, DC

Load Transient Response ( $V_{IN} = 1.8V$ )

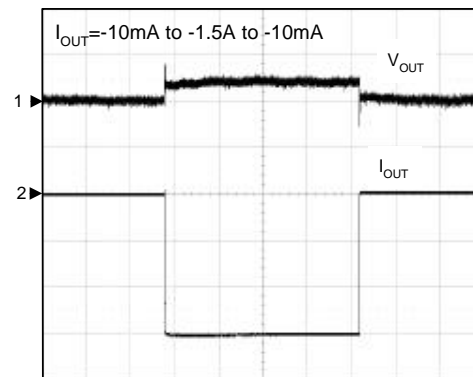

CH1:  $V_{OUT}$ , 20mV/Div, AC  
 CH2:  $I_{OUT}$ , 0.5A/Div, DC  
 TIME: 200µs/Div

Operating Waveforms (Cont.)

$V_{CNTL} = 5V$ ,  $V_{IN} = 1.8V$  or  $1.5V$ ,  $V_{REF} = 0.5 \times V_{IN}$ ,  $C_{IN} = C_{OUT} = 10\mu F$  (MLCC)

Load Transient Response ( $V_{IN} = 1.8V$ )

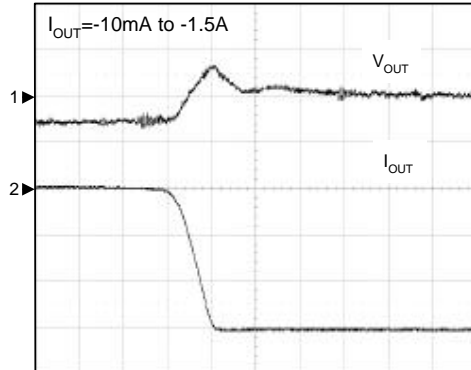

CH1:  $V_{OUT}$ , 20mV/Div, AC  
 CH2:  $I_{OUT}$ , 0.5A/Div, DC  
 TIME: 1 $\mu$ s/Div

Load Transient Response ( $V_{IN} = 1.8V$ )

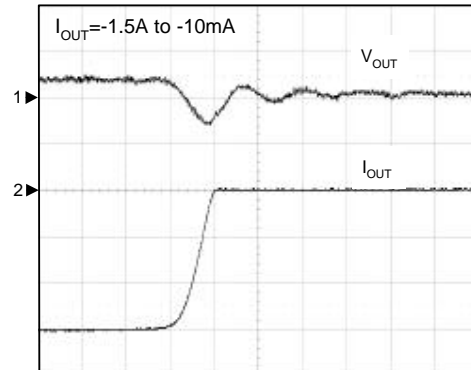

CH1:  $V_{OUT}$ , 20mV/Div, AC  
 CH2:  $I_{OUT}$ , 0.5A/Div, DC  
 TIME: 1 $\mu$ s/Div

Load Transient Response ( $V_{IN} = 1.5V$ )

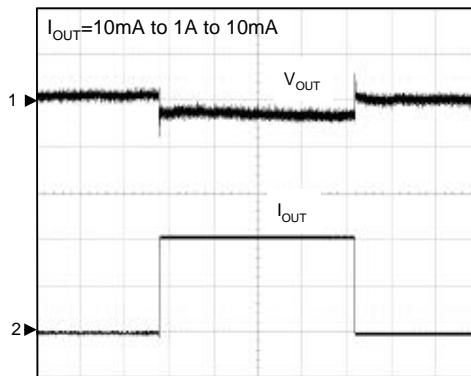

CH1:  $V_{OUT}$ , 20mV/Div, AC  
 CH2:  $I_{OUT}$ , 0.5A/Div, DC  
 TIME: 200 $\mu$ s/Div

Load Transient Response ( $V_{IN} = 1.5V$ )

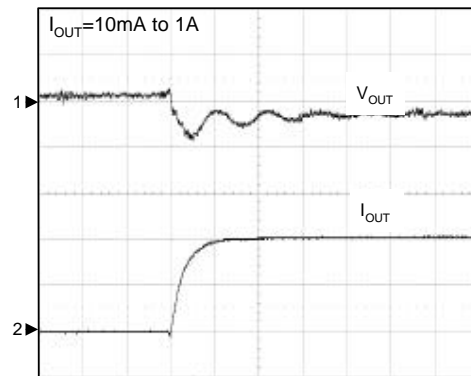

CH1:  $V_{OUT}$ , 20mV/Div, AC  
 CH2:  $I_{OUT}$ , 0.5A/Div, DC  
 TIME: 1 $\mu$ s/Div

Operating Waveforms (Cont.)

$V_{CNTL} = 5V$ ,  $V_{IN} = 1.8V$  or  $1.5V$ ,  $V_{REF} = 0.5 \times V_{IN}$ ,  $C_{IN} = C_{OUT} = 10\mu F$  (MLCC)

Load Transient Response ( $V_{IN} = 1.5V$ )

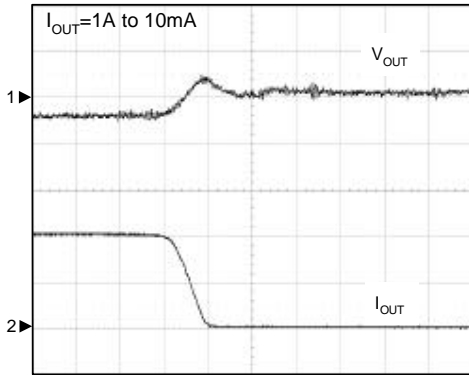

CH1:  $V_{OUT}$ , 20mV/Div, AC  
 CH2:  $I_{OUT}$ , 0.5A/Div, DC  
 TIME: 1 $\mu$ s/Div

Load Transient Response ( $V_{IN} = 1.5V$ )

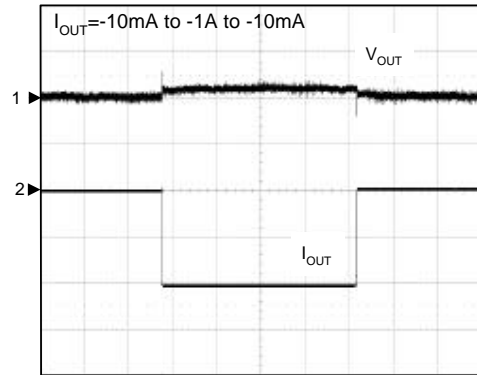

CH1:  $V_{OUT}$ , 20mV/Div, AC  
 CH2:  $I_{OUT}$ , 0.5A/Div, DC  
 TIME: 200 $\mu$ s/Div

Load Transient Response ( $V_{IN} = 1.5V$ )

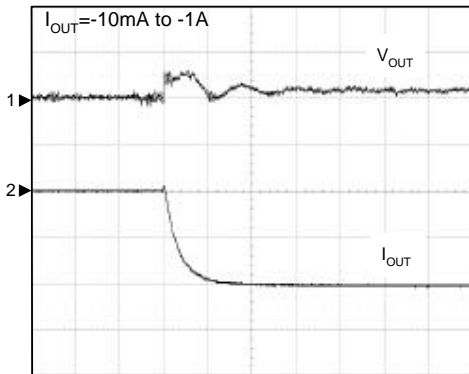

CH1:  $V_{OUT}$ , 20mV/Div, AC  
 CH2:  $I_{OUT}$ , 0.5A/Div, DC  
 TIME: 1 $\mu$ s/Div

Load Transient Response ( $V_{IN} = 1.5V$ )

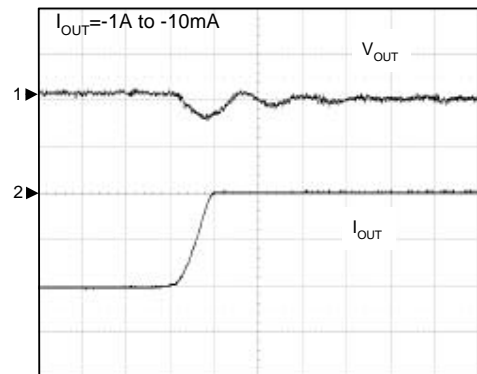

CH1:  $V_{OUT}$ , 20mV/Div, AC  
 CH2:  $I_{OUT}$ , 0.5A/Div, DC  
 TIME: 1 $\mu$ s/Div



Operating Waveforms (Cont.)

$V_{CNTL} = 5V$ ,  $V_{IN} = 1.8V$  or  $1.5V$ ,  $V_{REF} = 0.5 \times V_{IN}$ ,  $C_{IN} = C_{OUT} = 10\mu F$  (MLCC)

Power ON Test ( $V_{IN} = 1.8V$ )

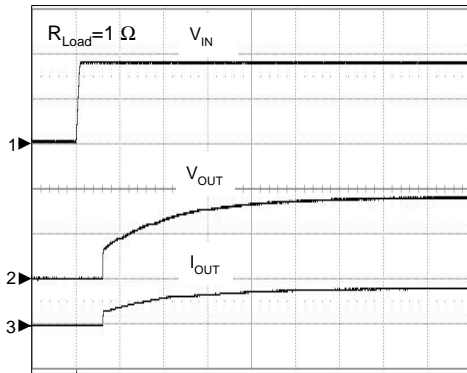

CH1:  $V_{IN}$ , 1V/Div, DC  
 CH2:  $V_{OUT}$ , 500mV/Div, DC  
 CH3:  $I_{OUT}$ , 1A/Div, DC  
 TIME: 50ms/Div

Power OFF Test ( $V_{IN} = 1.8V$ )

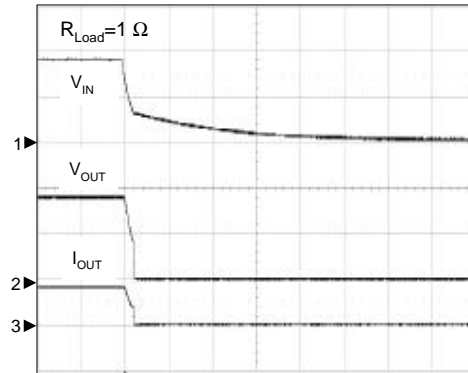

CH1:  $V_{IN}$ , 1V/Div, DC  
 CH2:  $V_{OUT}$ , 500mV/Div, DC  
 CH3:  $I_{OUT}$ , 1A/Div, DC  
 TIME: 5ms/Div

Power ON Test ( $V_{IN} = 1.5V$ )

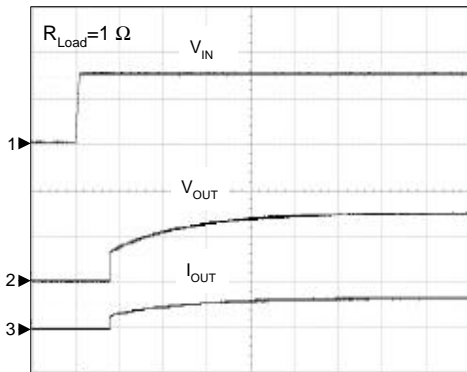

CH1:  $V_{IN}$ , 1V/Div, DC  
 CH2:  $V_{OUT}$ , 500mV/Div, DC  
 CH3:  $I_{OUT}$ , 1A/Div, DC  
 TIME: 50ms/Div

Power OFF Test ( $V_{IN} = 1.5V$ )

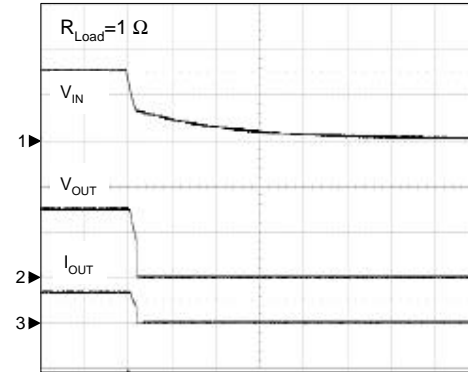

CH1:  $V_{IN}$ , 1V/Div, DC  
 CH2:  $V_{OUT}$ , 500mV/Div, DC  
 CH3:  $I_{OUT}$ , 1A/Div, DC  
 TIME: 5ms/Div

### Pin Description

PIN NO.	PIN NAME	FUNCTION
1	VIN	Main Power Input Pin. Connect this pin to a voltage source and an input capacitor. The APL5336 sources current to VOUT pin by controlling the upper pass MOSFET, providing a current path from VIN to VOUT.
2	GND	Power and Signal Ground. Connect this pin to system ground plane with shortest traces. The APL5336 sinks current from VOUT pin by controlling the lower pass MOSFET, providing a current path from VOUT to GND. This pin is also the ground path for internal control circuitry.
3	VREF	Reference Voltage Input and Active-high Enable Control Pin. Apply a voltage to this pin as a reference voltage for the APL5336. Connect this pin to a resistor divider, between VIN and GND, and a capacitor for filtering noise purpose. Applying and holding the voltage below the enable voltage threshold on this pin by an open-drain transistor shuts down the output. During shutdown, the VOUT pin has high input impedance.
4	VOUT	Output Pin of The Regulator. Connect this pin to load and output capacitors (>8μF MLCC is necessary) required for stability and improving transient response. The output voltage is regulated to track the reference voltage and capable of sourcing or sinking current up to 1.5A.
5, 7, 8 (SOP-8P)	NC	No Internal Connection.
5 ~ 8 (SOP-8) 6 (SOP-8P)	VCNTL	Power Input Pin for Internal Control Circuitry. Connect this pin to a voltage source, providing a bias for the internal control circuitry. A decoupling capacitor is connected near this pin.
Exposed Pad (SOP-8P only)	GND	Chip Substrate Connection of The Chip. Connect this pad to system ground plane for good thermal conductivity.

### Block Diagram

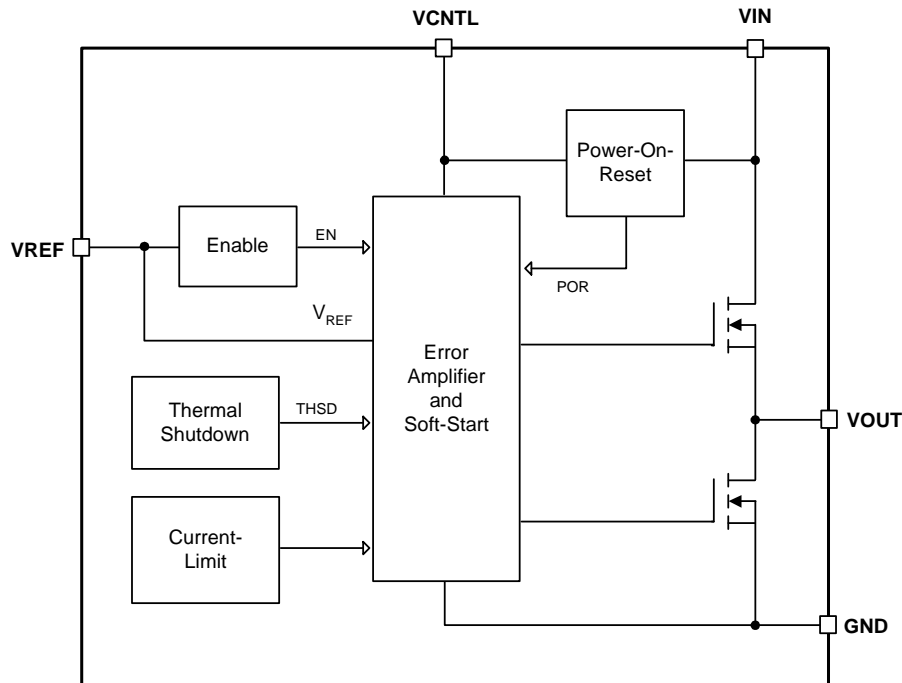

## Typical Application Circuit

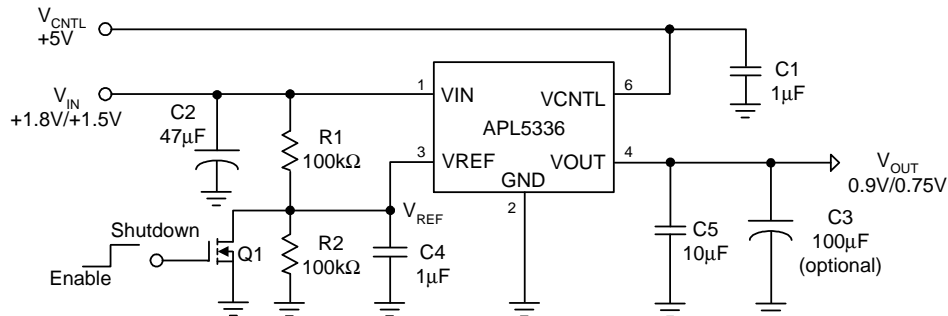

The ceramic capacitor C5 ( at least 8µF) is necessary for output stability.

## Function Description

### Power-On-Reset

A Power-On-Reset (POR) circuit monitors both input voltages at VCNTL and VIN pins to prevent wrong logic controls. The POR function initiates a soft-start process after both of the supply voltages exceed their rising POR voltage thresholds during powering on.

### Output Voltage Regulation

The output voltage on VOUT pin is regulated to track the reference voltage applied on VREF pin. Two internal N-channel power MOSFETs controlled by high bandwidth error amplifiers regulate the output voltage by sourcing current from VIN pin or sinking current to GND pin. An internal output voltage sense pad is bonded to the VOUT pin with a bonding wire for perfect load regulation.

For preventing the two power MOSFETs from shoot-through, a small voltage offset between the positive inputs of the two error amplifiers is designed. It results in higher output voltage while the regulator sinks light or heavy load current.

The APL5336 provides very fast load transient response at small output capacitance to save total cost.

### Current-Limit

The APL5336 monitors the output current, both sourcing and sinking current, and limits the maximum output current to prevent damages during current overload or short-circuit (shorted from VOUT to GND or VIN) conditions.

### Enable

The VREF pin is a multi-function input pin which is the reference voltage input pin and the enable control input pin. Applying and holding the voltage ( $V_{REF}$ ) on VREF be-

low 0.3V (typical) shuts down the output of the regulator. In the typical application, an NPN transistor or N-channel MOSFET is used to pull down the  $V_{REF}$  while applying a “high” signal to turn on the transistor. When shutdown function is active, both of the internal power MOSFETs are turned off and the impedance of the VOUT pin is larger than 10MΩ.

### Internal and External Soft-Start

The APL5336 is designed with an internal soft-start function to control the rise rate of the output voltage to prevent inrush current during start-up.

When release the pull-low transistor connected with VREF pin, the current via the resistor divider charges the external soft-start capacitor (C4) and the  $V_{REF}$  starts to rise up. The IC starts a soft-start process when the  $V_{REF}$  reaches the enable voltage threshold. The output voltage is regulated to follow the lower voltage, which is either the internal soft-start voltage ramp or the VREF voltage, to rise up. The external soft-start interval is programmable by the resistor-divider and the soft-start capacitor (C4).

### Thermal Shutdown

The thermal shutdown circuit limits the junction temperature of the APL5336. When the junction temperature exceeds 150°C, a thermal sensor turns off the both pass transistors, allowing the device to cool down. The thermal sensor allows the regulator to regulate again after the junction temperature cools by 40°C, resulting in a pulsed output during continuous thermal overload conditions. The thermal limit is designed with a 40°C hysteresis to lower the average  $T_J$  during continuous thermal overload conditions, increasing lifetime of the APL5336.

## Application Information

### Power Sequencing

The input sequence of powers applied for VIN and VCNTL is not necessary to be concerned.

### Reference Voltage

A reference voltage is applied at the VREF pin by a resistor divider between VIN and GND pins. An external bypass capacitor is also connected to VREF. The capacitor and the resistor divider form a low-pass filter to reduce the inherent reference noise from VIN. The capacitor is a 0.1μF or greater ceramic capacitor and connected as close to VREF as possible. More capacitance and large resistor divider will increase the soft-start interval. Do not place any additional loading on this reference input pin.

### Input Capacitor

The APL5336 requires proper input capacitors to supply current surge during stepping load transients to prevent the input rail from dropping. Because the parasitic inductors from the voltage sources or other bulk capacitors to the VIN pin limit the slew rate of the input current, more parasitic inductance needs more input capacitance. For the APL5336, the total capacitance of input capacitors value including MLCC and aluminum electrolytic capacitors should be larger than 10μF.

For VCNTL pin, a capacitor of 0.47μF (MLCC) or above is recommended for noise decoupling.

### Output Capacitor

The APL5336 needs a proper output capacitor to maintain circuit stability and improve transient response. In order to insure the circuit stability, a 10μF X5R or X7R MLCC output capacitor is sufficient at all operating temperatures and it **must be** placed near the VOUT. The maximum distance from output capacitor to VOUT must within 10mm. Total output capacitors value including MLCC and aluminum electrolytic capacitors should be larger than 10μF.

Table 1 provides the suitable output capacitors for APL5336

Vendor	Description
Murata	10μF, 6.3V, X7R, 0805, GRM21BR70J106K
	10μF, 6.3V, X5R, 0805, GRM21BR60J106K

Murata website: www.murata.com

Table 1: Output Capacitor Guide

### Operation Region and Power Dissipation

The APL5336 maximum power dissipation depends on the thermal resistance and temperature difference between the die junction and ambient air. The power dissipation  $P_D$  across the device is:

$$P_D \leq \frac{(T_J - T_A)}{\theta_{JA}}$$

Where  $(T_J - T_A)$  is the temperature difference between the junction and ambient air.  $\theta_{JA}$  is the thermal resistance between junction and ambient air. Assuming the  $T_A = 25^\circ\text{C}$  and maximum  $T_J = 150^\circ\text{C}$  (typical thermal limit threshold), the maximum power dissipation is calculated as:

$$P_{D(\max)} = \frac{(150 - 25)}{80} = 1.56(\text{W})$$

For normal operation, do not exceed the maximum junction temperature of  $T_J = 125^\circ\text{C}$ . The calculated power dissipation should less than:

$$P_D = \frac{(125 - 25)}{80} = 1.25(\text{W})$$

### PCB Layout Consideration

Figure 1 illustrates the layout. Below is a checklist for your layout:

1. Please place the input capacitors close to the VIN.
2. Please place the output capacitors close to the VOUT, a MLCC capacitor larger than 8μF **must be** placed near the VOUT. The distance from VOUT to output MLCC must be less than 10mm.
3. To place APL5336 and output capacitors near the load is good for load transient response.

## Application Information (Cont.)

### PCB Layout Consideration (Cont.)

4. Large current paths, the bold lines in Figure 1, must have wide tracks.
5. For SOP-8P package, please solder the thermal pad to the APL5336 to top-layer ground plane. Numerous vias 0.254mm in diameter should be used to connect both top-layer and internal ground planes. The ground planes and PCB form a heat sink to channel major power dissipation of the APL5336 into ambient air.

Large ground plane is good for heatsinking. Optimum performance can only be achieved when the device is mounted on a PC board according to the board layout diagrams which are shown as Figure 2.

### Recommended Minimum Footprint

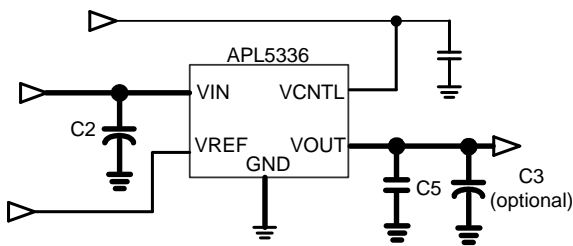
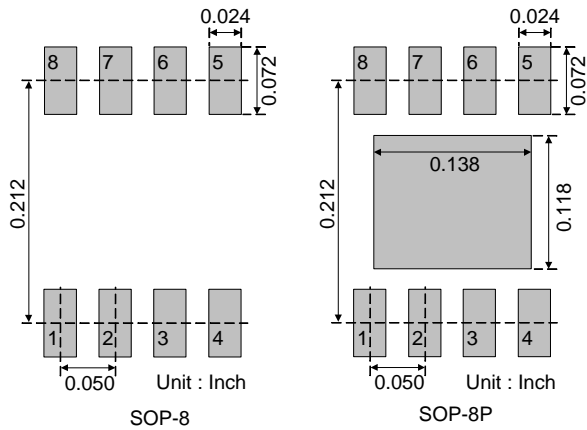
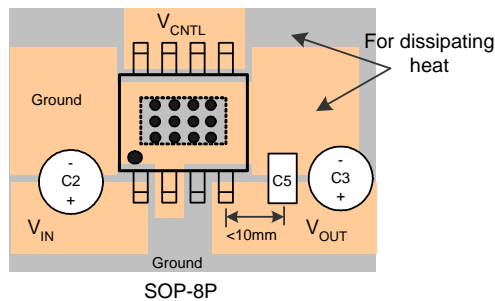
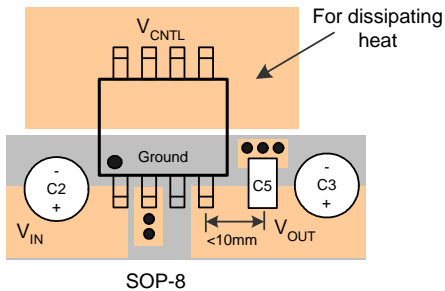
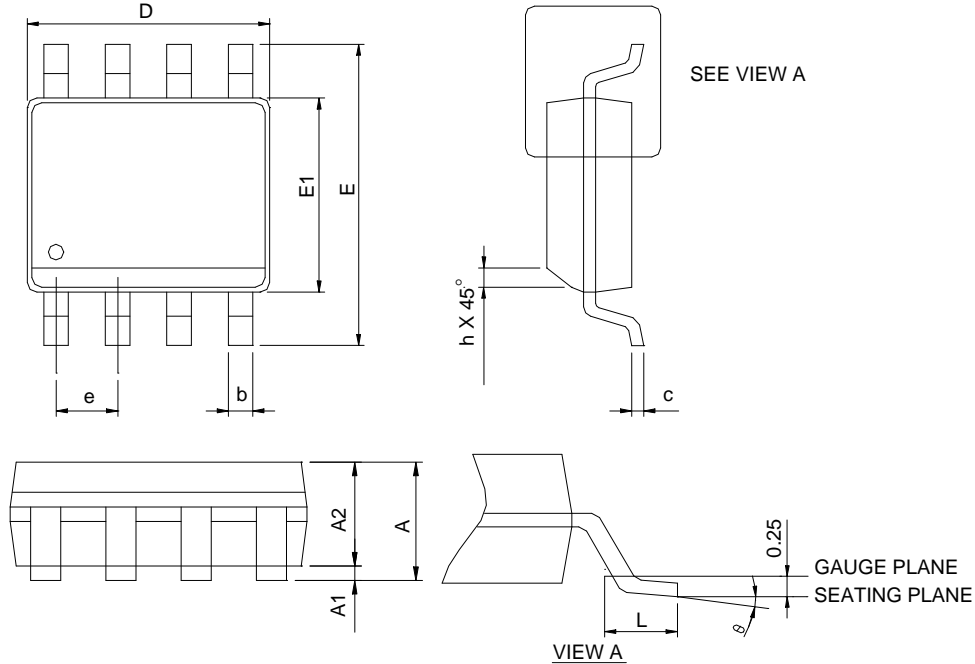

Figure 1



Package Information

SOP-8



SYMBOL	SOP-8			
	MILLIMETERS		INCHES	
	MIN.	MAX.	MIN.	MAX.
A		1.75		0.069
A1	0.10	0.25	0.004	0.010
A2	1.25		0.049	
b	0.31	0.51	0.012	0.020
c	0.17	0.25	0.007	0.010
D	4.80	5.00	0.189	0.197
E	5.80	6.20	0.228	0.244
E1	3.80	4.00	0.150	0.157
e	1.27 BSC		0.050 BSC	
h	0.25	0.50	0.010	0.020
L	0.40	1.27	0.016	0.050
θ	0°	8°	0°	8°

- Note: 1. Follow JEDEC MS-012 AA.  
 2. Dimension "D" does not include mold flash, protrusions or gate burrs. Mold flash, protrusion or gate burrs shall not exceed 6 mil per side.  
 3. Dimension "E" does not include inter-lead flash or protrusions. Inter-lead flash and protrusions shall not exceed 10 mil per side.

Package Information

SOP-8P

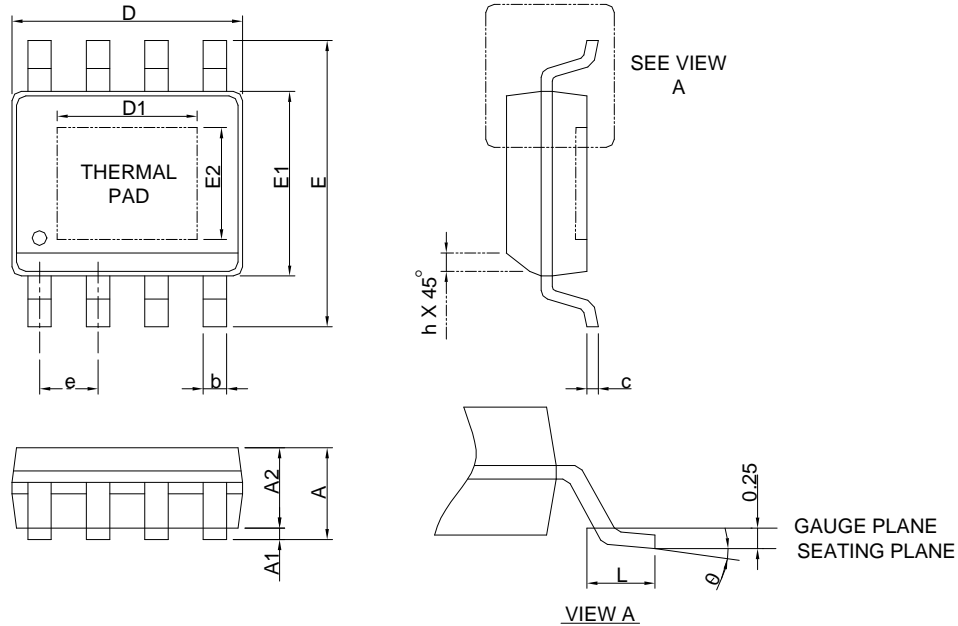

SYMBOL	SOP-8P			
	MILLIMETERS		INCHES	
	MIN.	MAX.	MIN.	MAX.
A		1.60		0.063
A1	0.00	0.15	0.000	0.006
A2	1.25		0.049	
b	0.31	0.51	0.012	0.020
c	0.17	0.25	0.007	0.010
D	4.80	5.00	0.189	0.197
D1	2.25	3.50	0.098	0.138
E	5.80	6.20	0.228	0.244
E1	3.80	4.00	0.150	0.157
E2	2.00	3.00	0.079	0.118
e	1.27 BSC		0.050 BSC	
h	0.25	0.50	0.010	0.020
L	0.40	1.27	0.016	0.050
theta	0°	8°	0°	8°

Note : 1. Follow JEDEC MS-012 BA.

2. Dimension "D" does not include mold flash, protrusions or gate burrs. Mold flash, protrusion or gate burrs shall not exceed 6 mil per side .
3. Dimension "E" does not include inter-lead flash or protrusions. Inter-lead flash and protrusions shall not exceed 10 mil per side.

Carrier Tape & Reel Dimensions

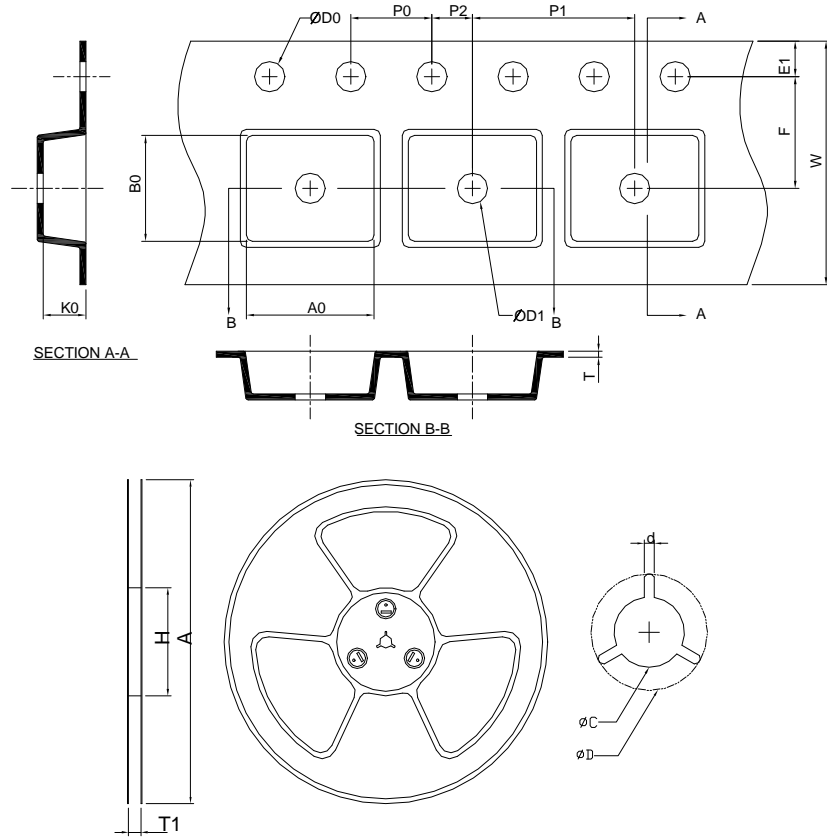

Application	A	H	T1	C	d	D	W	E1	F
SOP-8(P)	330.0 ±0.00	50 MIN.	12.4+2.00 -0.00	13.0+0.50 -0.20	1.5 MIN.	20.2 MIN.	12.0 ±0.30	1.75 ±0.10	5.5 ±0.05
	P0	P1	P2	D0	D1	T	A0	B0	K0
	4.0 ±0.10	8.0 ±0.10	2.0 ±0.05	1.5+0.10 -0.00	1.5 MIN.	0.6+0.00 -0.40	6.40 ±0.20	5.20 ±0.20	2.10 ±0.20

(mm)

Devices Per Unit

Package Type	Unit	Quantity
SOP-8(P)	Tape & Reel	2500



**Reflow Condition (IR/Convection or VPR Reflow)**

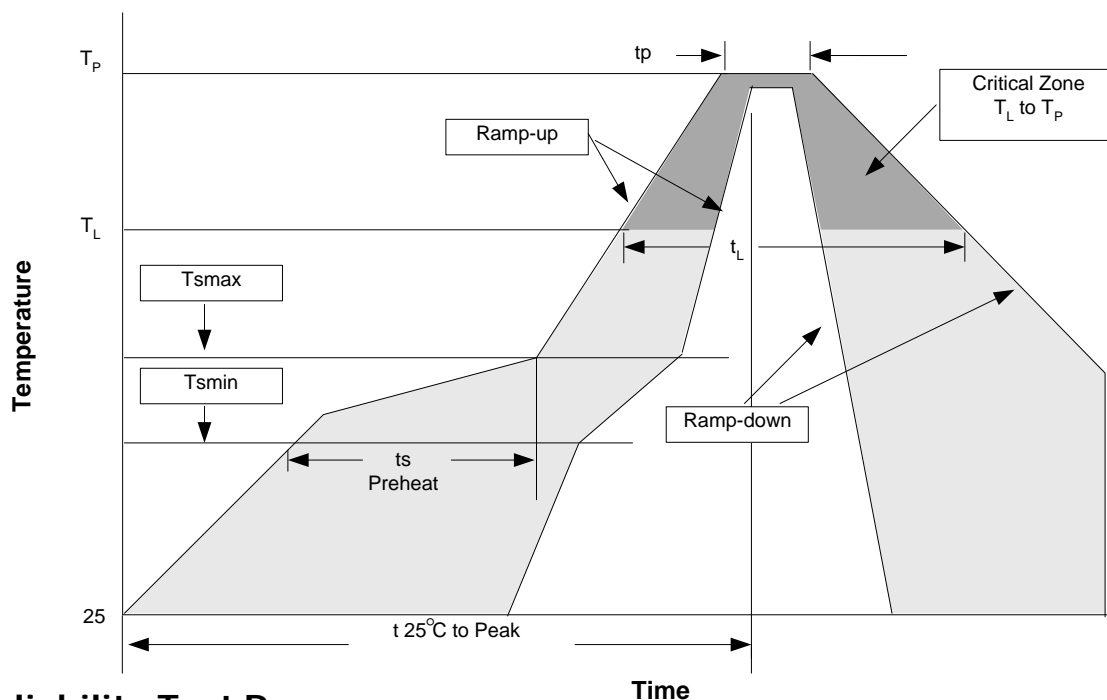

**Reliability Test Program**

Test item	Method	Description
SOLDERABILITY	MIL-STD-883D-2003	245°C, 5 sec
HOLT	MIL-STD-883D-1005.7	1000 Hrs Bias @125°C
PCT	JESD-22-B, A102	168 Hrs, 100%RH, 121°C
TST	MIL-STD-883D-1011.9	-65°C~150°C, 200 Cycles
ESD	MIL-STD-883D-3015.7	VHBM > 2KV, VMM > 200V
Latch-Up	JESD 78	10ms, $I_{tr} > 100mA$

**Classification Reflow Profiles**

Profile Feature	Sn-Pb Eutectic Assembly	Pb-Free Assembly
Average ramp-up rate ( $T_L$ to $T_P$ )	3°C/second max.	3°C/second max.
Preheat		
- Temperature Min ( $T_{smin}$ )	100°C	150°C
- Temperature Max ( $T_{smax}$ )	150°C	200°C
- Time (min to max) ( $t_s$ )	60-120 seconds	60-180 seconds
Time maintained above:		
- Temperature ( $T_L$ )	183°C	217°C
- Time ( $t_L$ )	60-150 seconds	60-150 seconds
Peak/Classification Temperature ( $T_p$ )	See table 1	See table 2
Time within 5°C of actual Peak Temperature ( $t_p$ )	10-30 seconds	20-40 seconds
Ramp-down Rate	6°C/second max.	6°C/second max.
Time 25°C to Peak Temperature	6 minutes max.	8 minutes max.

Note: All temperatures refer to topside of the package. Measured on the body surface.

**Classification Reflow Profiles (Cont.)**

Table 1. SnPb Eutectic Process – Package Peak Reflow Temperatures

Package Thickness	Volume mm <sup>3</sup> <350	Volume mm <sup>3</sup> ≥350
<2.5 mm	240 +0/-5°C	225 +0/-5°C
≥2.5 mm	225 +0/-5°C	225 +0/-5°C

Table 2. Pb-free Process – Package Classification Reflow Temperatures

Package Thickness	Volume mm <sup>3</sup> <350	Volume mm <sup>3</sup> 350-2000	Volume mm <sup>3</sup> >2000
<1.6 mm	260 +0°C*	260 +0°C*	260 +0°C*
1.6 mm – 2.5 mm	260 +0°C*	250 +0°C*	245 +0°C*
≥2.5 mm	250 +0°C*	245 +0°C*	245 +0°C*

\* Tolerance: The device manufacturer/supplier **shall** assure process compatibility up to and including the stated classification temperature (this means Peak reflow temperature +0°C. For example 260°C+0°C) at the rated MSL level.

**Customer Service**

**Anpec Electronics Corp.**

Head Office :

No.6, Dusing 1st Road, SBIP,  
Hsin-Chu, Taiwan, R.O.C.  
Tel : 886-3-5642000  
Fax : 886-3-5642050

Taipei Branch :

2F, No. 11, Lane 218, Sec 2 Jhongsing Rd.,  
Sindian City City, Taipei County 23146, Taiwan  
Tel : 886-2-2910-3838  
Fax : 886-2-2917-3838