

# RED LASER DIODE

## DL-5147-042

# SANYO

Ver.1 July. 2002

### Features

- Short wavelength : 655 nm (Typ.)
- High output power : 30 mW at 60°C (CW)
- Low threshold current :  $I_{th} = 40$  mA (Typ.)
- Small package :  $\phi 5.6$  mm
- TE mode

### Applications

Bar-code scanner

### Absolute Maximum Ratings

(T<sub>c</sub>=25°C)

Parameter		Symbol	Ratings	Unit
Light Output	CW	P <sub>o</sub> (CW)	30	mW
	Pulse <sup>1)</sup>	P <sub>o</sub> (pulse)	50	
Reverse Voltage	Laser	V <sub>R</sub>	2	V
	PD		30	
Operating Temperature		T <sub>opr</sub>	-10 to +60	°C
Storage Temperature		T <sub>stg</sub>	-40 to +85	°C

1) Pulse Width 0.5μs, Duty 50%

### Electrical and Optical Characteristics

2) 3)

(T<sub>c</sub>=25°C)

Parameter		Symbol	Condition	Min.	Typ.	Max.	Unit
Threshold Current		I <sub>th</sub>	CW	-	40	50	mA
Operating Current		I <sub>op</sub>	P <sub>o</sub> =30mW	-	80	110	mA
Operating Voltage		V <sub>op</sub>	P <sub>o</sub> =30mW	-	2.4	2.8	V
Lasing Wavelength		L <sub>p</sub>	P <sub>o</sub> =30mW	-	655	665	nm
Beam <sup>4)</sup> Divergence	Perpendicular	Q <sub>v</sub>	P <sub>o</sub> =30mW	15	23	28	°
	Parallel	Q <sub>h</sub>	P <sub>o</sub> =30mW	6	7	10	°
Off Axis Angle	Perpendicular	dQ <sub>v</sub>	-	-	-	± 3	°
	Parallel	dQ <sub>h</sub>	-	-	-	± 3	°
Differential Efficiency		dP <sub>o</sub> /dI <sub>op</sub>	-	-	0.75	-	mW/mA
Monitoring Output Current		I <sub>m</sub> <sup>5)</sup>	P <sub>o</sub> =30mW	0,1	0.3	-	mA
Astigmatism		A <sub>s</sub>	P <sub>o</sub> =30mW	-	10	-	μm

2) Initial values 3) All the above values are evaluated with Tottori Sanyo's measuring apparatus

4) Full angle at half maximum

Note : The above product specification are subject to change without notice.

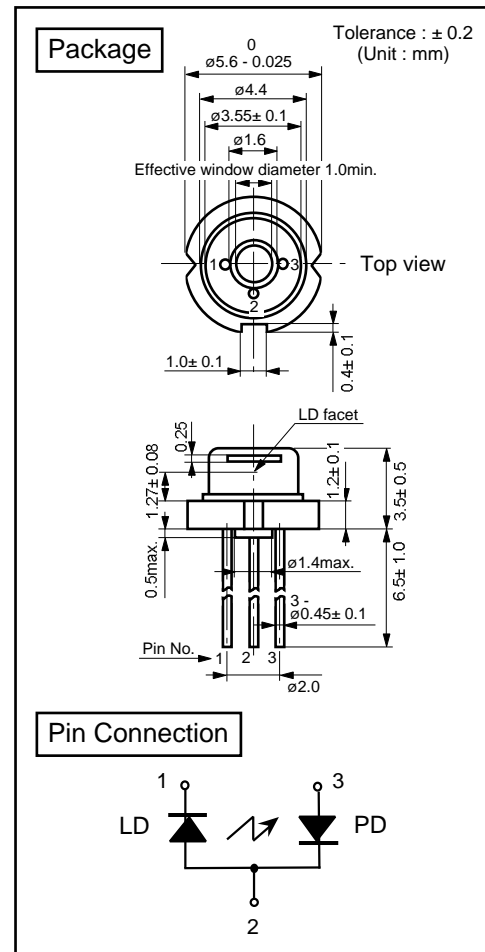

## Characteristics

### Output power vs. Forward current

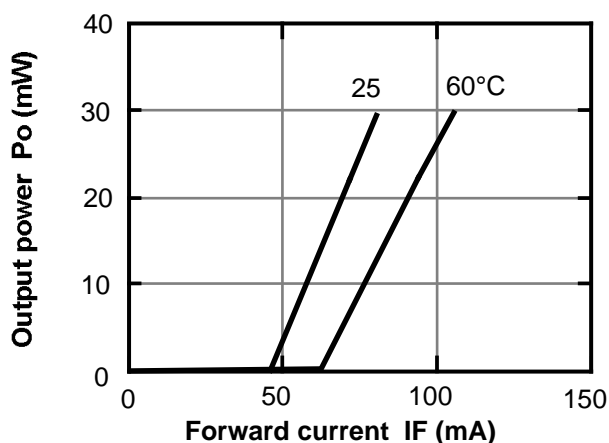

### Threshold current vs. Temperature

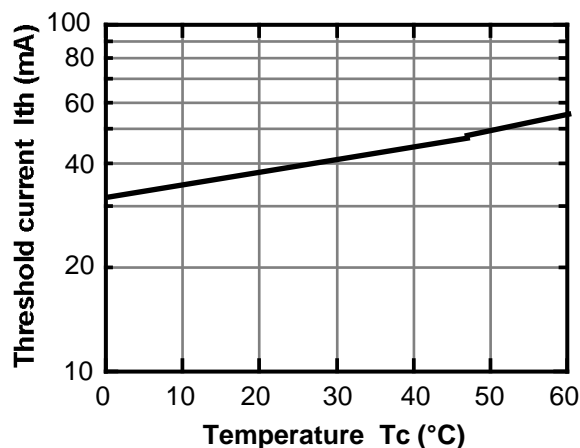

### Monitoring current vs. Output power

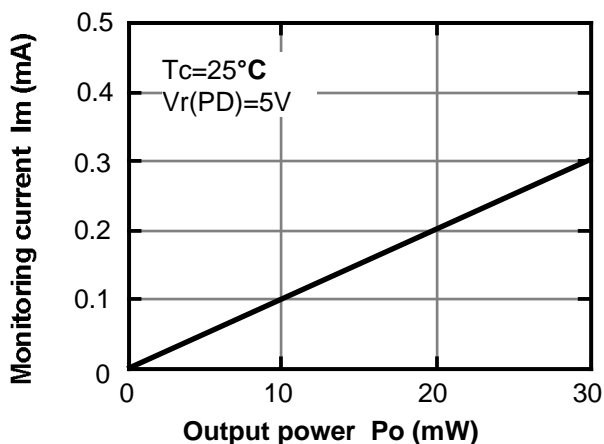

### Beam divergence

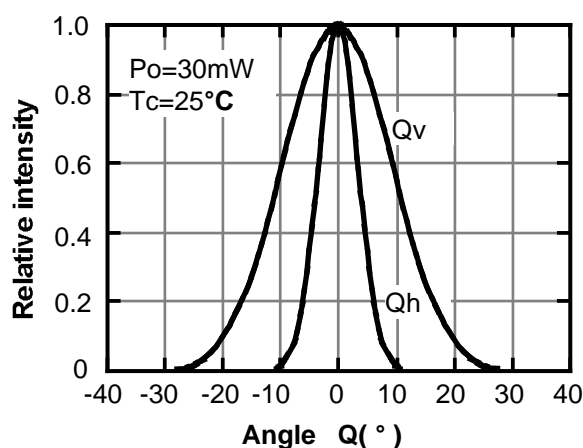

### Lasing wavelength vs. Temperature

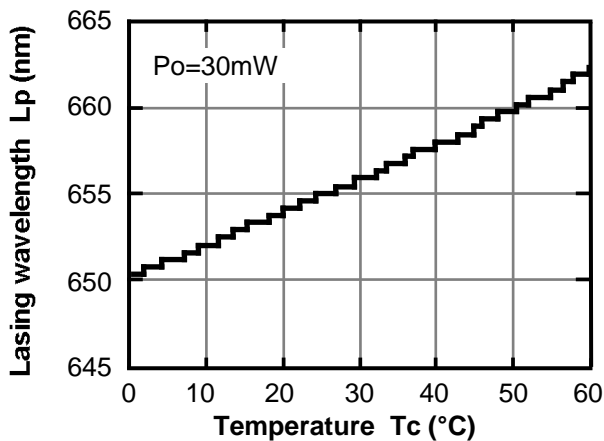

### Lasing wavelength vs. Output power

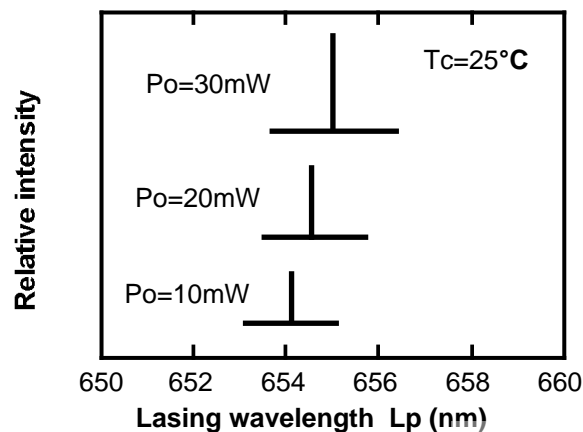

This is typical data and it may not represent all products.