HA17800V/VP/VPJ Series

3-terminal Fixed Voltage Regulators

HITACHI

Description

HA17800V series is positive output 1 A three-terminal regulator IC. Which features are as follows. It is designed to suit to the power supply of various equipments and to stabilize the multi switching regulator voltage, and to supply power to some kind of control devices.

Features

- High ripple rejection ratio up to high frequency
(f = 20 kHz): 60 dB(in the case of HA17805V/VP/VPJ)
- Protected against oscillation
- Regulated output voltage against temperature
(0 Ta = 125°C, 80 ppm/°C typ)
- Hard to breakdown against irrelevant connection
- Built-in circuits as over current control circuit, temperature protection circuit, and area of safety operation control circuit

Ordering Information

Output Voltage (V)	Automotive Use	Industrial Use	Commercial Use	Package
5	HA17805VPJ	HA17805VP	HA17805V	TO - 220AB
6	HA17806VPJ	HA17806VP	HA17806V	
7	HA17807VPJ	HA17807VP	HA17807V	
8	HA17808VPJ	HA17808VP	HA17808V	
12	HA17812VPJ	HA17812VP	HA17812V	
15	HA17815VPJ	HA17815VP	HA17815V	
18	HA17818VPJ	HA17818VP	HA17818V	
24	HA17824VPJ	HA17824VP	HA17824V	

Pin Arrangement

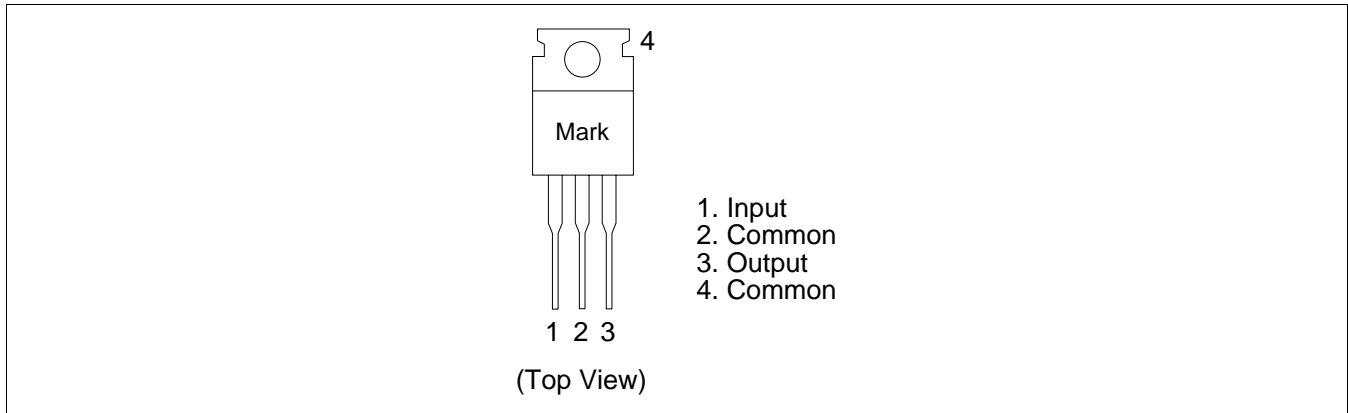

Block Diagram

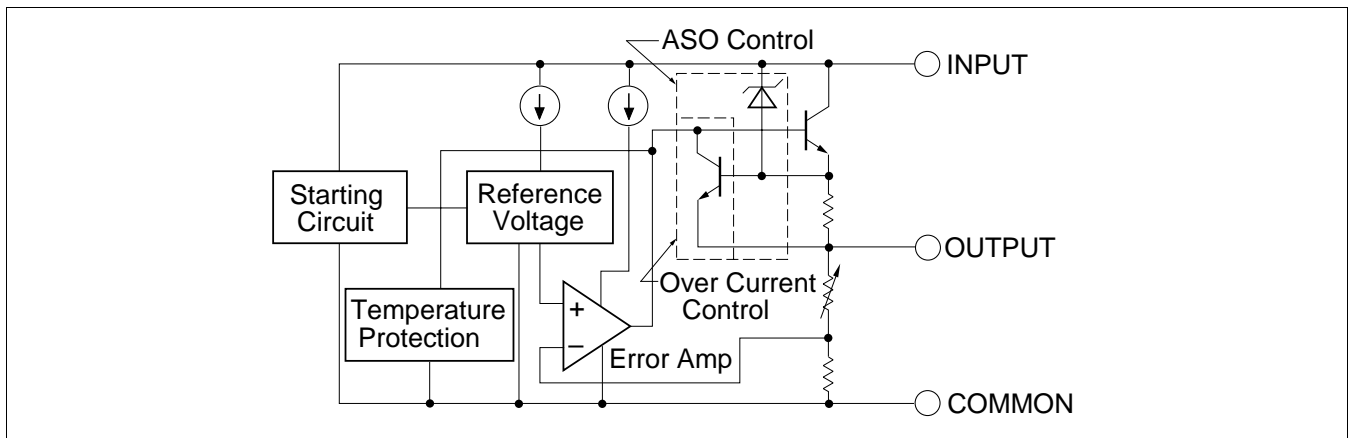

Standard Circuit

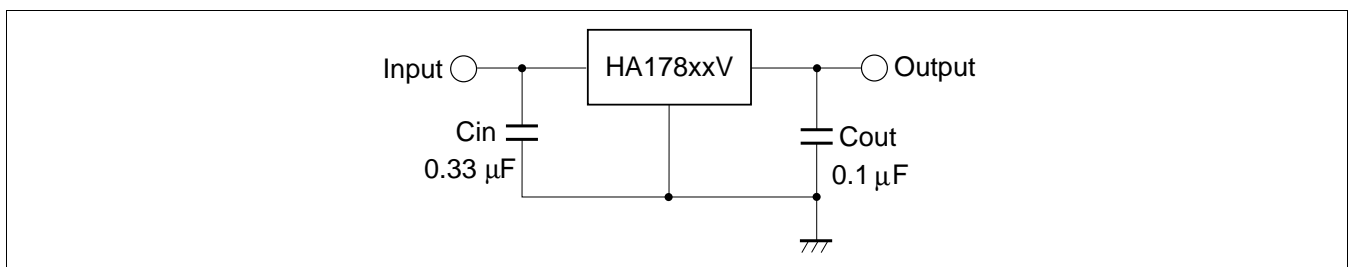

Absolute Maximum Ratings (Ta = 25°C)

Item	Symbol	Ratings		Unit	Notes
		HA17800V/VP	HA17800VPJ		
Input voltage	V_{IN}	35	35	V	1
Power dissipation	P_T	15	15	W	2
Operating ambient temperature	T_{opr}	-20 to +75	-40 to +85	°C	
Storage temperature	T_{stg}	-55 to +125	-50 to +125	°C	
Operating junction temperature	T_j	-20 to +125	-40 to +125	°C	

Notes: 1. HA17824V/VP/VPJ, 40 V
 2. Follow derating curve

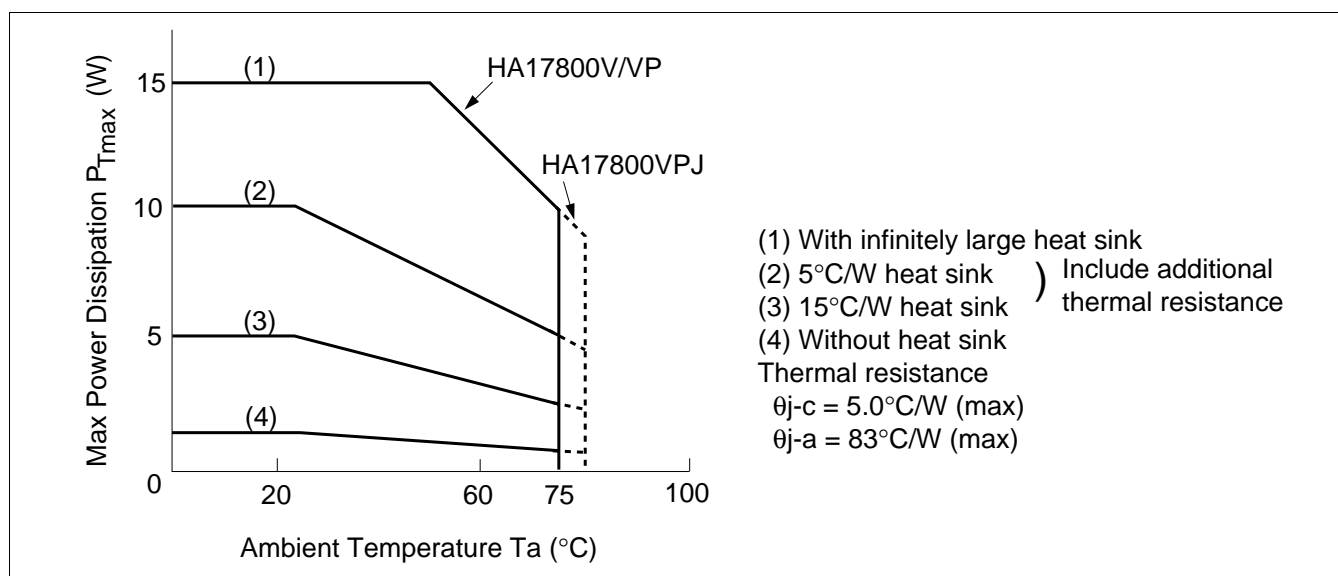

HA17800V/VP/VPJ Series

HA17805V/VP/VPJ Electrical Characteristics

($V_{IN} = 10\text{ V}$, $I_{OUT} = 500\text{ mA}$, $0^\circ\text{C} \leq T_j \leq 125^\circ\text{C}$, $C_{IN} = 0.33\text{ }\mu\text{F}$, $C_{OUT} = 0.1\text{ }\mu\text{F}$)

Item	Symbol	Min	Typ	Max	Unit	Test Conditions
Output voltage	V_{OUT1}	4.8	5.0	5.2	V	$T_j = 25^\circ\text{C}$
	V_{OUT2}	4.75	—	5.25	V	$7\text{ V} \leq V_{IN} \leq 20\text{ V}$, $5\text{ mA} \leq I_{OUT} \leq 1.0\text{ A}$, $P_T \leq 15\text{ W}$
Line regulation	δV_{OLine1}	—	30	100	mV	$T_j = 25^\circ\text{C}$, $7\text{ V} \leq V_{IN} \leq 25\text{ V}$
	δV_{OLine2}	—	10	50	mV	$T_j = 25^\circ\text{C}$, $8\text{ V} \leq V_{IN} \leq 12\text{ V}$
Load regulation	δV_{OLoad1}	—	30	100	mV	$T_j = 25^\circ\text{C}$, $5\text{ mA} \leq I_{OUT} \leq 1.5\text{ A}$
	δV_{OLoad2}	—	10	50	mV	$T_j = 25^\circ\text{C}$, $250\text{ mA} \leq I_{OUT} \leq 750\text{ mA}$
Quiescent current	I_Q	0.8	3.5	7.0	mA	$T_j = 25^\circ\text{C}$, $I_{OUT} = 0$
Quiescent current change	δI_{Q1}	—	—	1.3	mA	$7\text{ V} \leq V_{IN} \leq 25\text{ V}$
	δI_{Q2}	—	—	0.5	mA	$5\text{ mA} \leq I_{OUT} \leq 1.0\text{ A}$
Voltage drop	V_{drop}	—	2.0	2.5	V	$T_j = 25^\circ\text{C}$, $I_{OUT} = 1.0\text{ A}$
Ripple rejection ratio	R_{REJ}	—	60	—	dB	$T_j = 25^\circ\text{C}$, $f = 10\text{ kHz}$
Temperature coefficient of output voltage	$\delta V_{OUT}/\delta T_a$	—	-0.5	—	$\text{mV}/^\circ\text{C}$	$I_{OUT} = 5\text{ mA}$
Output noise voltage	V_n	—	120	—	μVrms	$T_j = 25^\circ\text{C}$, $10\text{ Hz} \leq f \leq 100\text{ kHz}$
Output short circuit current	I_{OS}	—	1.25	—	A	$T_j = 25^\circ\text{C}$
Peak output current	I_{op}	—	2.2	—	A	$T_j = 25^\circ\text{C}$

HA17806V/VP/VPJ Electrical Characteristics
 $(V_{IN} = 11\text{ V}, I_{OUT} = 500\text{ mA}, 0^{\circ}\text{C} \leq T_j \leq 125^{\circ}\text{C}, C_{IN} = 0.33\text{ }\mu\text{F}, C_{OUT} = 0.1\text{ }\mu\text{F})$

Item	Symbol	Min	Typ	Max	Unit	Test Conditions
Output voltage	V_{OUT1}	5.75	6.00	6.25	V	$T_j = 25^{\circ}\text{C}$
	V_{OUT2}	5.7	—	6.3	V	$8\text{ V} \leq V_{IN} \leq 21\text{ V}$, $5\text{ mA} \leq I_{OUT} \leq 1.0\text{ A}$, $P_T \leq 15\text{ W}$
Line regulation	δV_{OLine1}	—	36	120	mV	$T_j = 25^{\circ}\text{C}$, $8\text{ V} \leq V_{IN} \leq 25\text{ V}$
	δV_{OLine2}	—	12	60	mV	$T_j = 25^{\circ}\text{C}$, $9\text{ V} \leq V_{IN} \leq 13\text{ V}$
Load regulation	δV_{OLoad1}	—	36	120	mV	$T_j = 25^{\circ}\text{C}$, $5\text{ mA} \leq I_{OUT} \leq 1.5\text{ A}$
	δV_{OLoad2}	—	12	60	mV	$T_j = 25^{\circ}\text{C}$, $250\text{ mA} \leq I_{OUT} \leq 750\text{ mA}$
Quiescent current	I_Q	0.8	3.5	7.0	mA	$T_j = 25^{\circ}\text{C}$, $I_{OUT} = 0$
Quiescent current change	δI_{Q1}	—	—	1.3	mA	$8\text{ V} \leq V_{IN} \leq 25\text{ V}$
	δI_{Q2}	—	—	0.5	mA	$5\text{ mA} \leq I_{OUT} \leq 1.0\text{ A}$
Voltage drop	V_{drop}	—	2.0	2.5	V	$T_j = 25^{\circ}\text{C}$, $I_{OUT} = 1.0\text{ A}$
Ripple rejection ratio	R_{REJ}	—	60	—	dB	$T_j = 25^{\circ}\text{C}$, $f = 10\text{ kHz}$
Temperature coefficient of output voltage	$\delta V_{OUT}/\delta T_a$	—	-0.5	—	mV/°C	$I_{OUT} = 5\text{ mA}$
Output noise voltage	V_n	—	120	—	μVrms	$T_j = 25^{\circ}\text{C}$, $10\text{ Hz} \leq f \leq 100\text{ kHz}$
Output short circuit current	I_{OS}	—	1.2	—	A	$T_j = 25^{\circ}\text{C}$
Peak output current	I_{op}	—	2.2	—	A	$T_j = 25^{\circ}\text{C}$

HA17800V/VP/VPJ Series

HA17807V/VP/VPJ Electrical Characteristics

($V_{IN} = 12.5\text{ V}$, $I_{OUT} = 500\text{ mA}$, $0^\circ\text{C} \leq T_j \leq 125^\circ\text{C}$, $C_{IN} = 0.33\ \mu\text{F}$, $C_{OUT} = 0.1\ \mu\text{F}$)

Item	Symbol	Min	Typ	Max	Unit	Test Conditions
Output voltage	V_{OUT1}	6.72	7.00	7.28	V	$T_j = 25^\circ\text{C}$
	V_{OUT2}	6.65	—	7.35	V	$9\text{ V} \leq V_{IN} \leq 22\text{ V}$, $5\text{ mA} \leq I_{OUT} \leq 1.0\text{ A}$, $P_T \leq 15\text{ W}$
Line regulation	δV_{OLine1}	—	45	140	mV	$T_j = 25^\circ\text{C}$, $9\text{ V} \leq V_{IN} \leq 25\text{ V}$
	δV_{OLine2}	—	15	70	mV	$T_j = 25^\circ\text{C}$, $10\text{ V} \leq V_{IN} \leq 15\text{ V}$
Load regulation	δV_{OLoad1}	—	45	140	mV	$T_j = 25^\circ\text{C}$, $5\text{ mA} \leq I_{OUT} \leq 1.5\text{ A}$
	δV_{OLoad2}	—	15	70	mV	$T_j = 25^\circ\text{C}$, $250\text{ mA} \leq I_{OUT} \leq 750\text{ mA}$
Quiescent current	I_Q	0.8	3.5	7.0	mA	$T_j = 25^\circ\text{C}$, $I_{OUT} = 0$
Quiescent current change	δI_{Q1}	—	—	1.3	mA	$9\text{ V} \leq V_{IN} \leq 25\text{ V}$
	δI_{Q2}	—	—	0.5	mA	$5\text{ mA} \leq I_{OUT} \leq 1.0\text{ A}$
Voltage drop	V_{drop}	—	2.0	2.5	V	$T_j = 25^\circ\text{C}$, $I_{OUT} = 1.0\text{ A}$
Ripple rejection ratio	R_{REJ}	—	58	—	dB	$T_j = 25^\circ\text{C}$, $f = 10\text{ kHz}$
Temperature coefficient of output voltage	$\delta V_{OUT}/\delta T_a$	—	-0.6	—	mV/°C	$I_{OUT} = 5\text{ mA}$
Output noise voltage	V_n	—	140	—	μVrms	$T_j = 25^\circ\text{C}$, $10\text{ Hz} \leq f \leq 100\text{ kHz}$
Output short circuit current	I_{OS}	—	1.1	—	A	$T_j = 25^\circ\text{C}$
Peak output current	I_{op}	—	2.2	—	A	$T_j = 25^\circ\text{C}$

HA17808V/VP/VPJ Electrical Characteristics
 $(V_{IN} = 14\text{ V}, I_{OUT} = 500\text{ mA}, 0^{\circ}\text{C} \leq T_j \leq 125^{\circ}\text{C}, C_{IN} = 0.33\ \mu\text{F}, C_{OUT} = 0.1\ \mu\text{F})$

Item	Symbol	Min	Typ	Max	Unit	Test Conditions
Output voltage	V_{OUT1}	7.70	8.00	8.30	V	$T_j = 25^{\circ}\text{C}$
	V_{OUT2}	7.6	—	8.4	V	$10.5\text{ V} \leq V_{IN} \leq 23\text{ V}$, $5\text{ mA} \leq I_{OUT} \leq 1.0\text{ A}$, $P_T \leq 15\text{ W}$
Line regulation	δV_{OLine1}	—	58	160	mV	$T_j = 25^{\circ}\text{C}$, $10.5\text{ V} \leq V_{IN} \leq 25\text{ V}$
	δV_{OLine2}	—	20	80	mV	$T_j = 25^{\circ}\text{C}$, $11\text{ V} \leq V_{IN} \leq 17\text{ V}$
Load regulation	δV_{OLoad1}	—	58	160	mV	$T_j = 25^{\circ}\text{C}$, $5\text{ mA} \leq I_{OUT} \leq 1.5\text{ A}$
	δV_{OLoad2}	—	20	80	mV	$T_j = 25^{\circ}\text{C}$, $250\text{ mA} \leq I_{OUT} \leq 750\text{ mA}$
Quiescent current	I_Q	0.8	3.5	7.0	mA	$T_j = 25^{\circ}\text{C}$, $I_{OUT} = 0$
Quiescent current change	δI_{Q1}	—	—	1.0	mA	$10.5\text{ V} \leq V_{IN} \leq 25\text{ V}$
	δI_{Q2}	—	—	0.5	mA	$5\text{ mA} \leq I_{OUT} \leq 1.0\text{ A}$
Voltage drop	V_{drop}	—	2.0	2.5	V	$T_j = 25^{\circ}\text{C}$, $I_{OUT} = 1.0\text{ A}$
Ripple rejection ratio	R_{REJ}	—	58	—	dB	$T_j = 25^{\circ}\text{C}$, $f = 10\text{ kHz}$
Temperature coefficient of output voltage	$\delta V_{OUT}/\delta T_a$	—	-0.6	—	mV/°C	$I_{OUT} = 5\text{ mA}$
Output noise voltage	V_n	—	150	—	μV_{rms}	$T_j = 25^{\circ}\text{C}$, $10\text{ Hz} \leq f \leq 100\text{ kHz}$
Output short circuit current	I_{OS}	—	1.0	—	A	$T_j = 25^{\circ}\text{C}$
Peak output current	I_{op}	—	2.2	—	A	$T_j = 25^{\circ}\text{C}$

HA17800V/VP/VPJ Series

HA17812V/VP/VPJ Electrical Characteristics

($V_{IN} = 19\text{ V}$, $I_{OUT} = 500\text{ mA}$, $0^\circ\text{C} \leq T_j \leq 125^\circ\text{C}$, $C_{IN} = 0.33\ \mu\text{F}$, $C_{OUT} = 0.1\ \mu\text{F}$)

Item	Symbol	Min	Typ	Max	Unit	Test Conditions
Output voltage	V_{OUT1}	11.5	12.0	12.5	V	$T_j = 25^\circ\text{C}$
	V_{OUT2}	11.4	—	12.6	V	$14.5\text{ V} \leq V_{IN} \leq 27\text{ V}$, $5\text{ mA} \leq I_{OUT} \leq 1.0\text{ A}$, $PT \leq 15\text{ W}$
Line regulation	δV_{OLine1}	—	100	240	mV	$T_j = 25^\circ\text{C}$, $14.5\text{ V} \leq V_{IN} \leq 30\text{ V}$
	δV_{OLine2}	—	33	120	mV	$T_j = 25^\circ\text{C}$, $16\text{ V} \leq V_{IN} \leq 22\text{ V}$
Load regulation	δV_{OLoad1}	—	100	240	mV	$T_j = 25^\circ\text{C}$, $5\text{ mA} \leq I_{OUT} \leq 1.5\text{ A}$
	δV_{OLoad2}	—	33	120	mV	$T_j = 25^\circ\text{C}$, $250\text{ mA} \leq I_{OUT} \leq 750\text{ mA}$
Quiescent current	I_Q	0.8	3.6	7.2	mA	$T_j = 25^\circ\text{C}$, $I_{OUT} = 0$
Quiescent current change	δI_{Q1}	—	—	1.0	mA	$14.5\text{ V} \leq V_{IN} \leq 30\text{ V}$
	δI_{Q2}	—	—	0.5	mA	$5\text{ mA} \leq I_{OUT} \leq 1.0\text{ A}$
Voltage drop	V_{drop}	—	2.0	2.5	V	$T_j = 25^\circ\text{C}$, $I_{OUT} = 1.0\text{ A}$
Ripple rejection ratio	R_{REJ}	—	58	—	dB	$T_j = 25^\circ\text{C}$, $f = 10\text{ kHz}$
Temperature coefficient of output voltage	$\delta V_{OUT}/\delta T_a$	—	-0.8	—	mV/°C	$I_{OUT} = 5\text{ mA}$
Output noise voltage	V_n	—	290	—	μV_{rms}	$T_j = 25^\circ\text{C}$, $10\text{ Hz} \leq f \leq 100\text{ kHz}$
Output short circuit current	I_{OS}	—	0.6	—	A	$T_j = 25^\circ\text{C}$
Peak output current	I_{op}	—	2.1	—	A	$T_j = 25^\circ\text{C}$

HA17815V/VP/VPJ Electrical Characteristics
 $(V_{IN} = 23 \text{ V}, I_{OUT} = 500 \text{ mA}, 0^\circ\text{C} \leq T_j \leq 125^\circ\text{C}, C_{IN} = 0.33 \mu\text{F}, C_{OUT} = 0.1 \mu\text{F})$

Item	Symbol	Min	Typ	Max	Unit	Test Conditions
Output voltage	V_{OUT1}	14.4	15.0	15.6	V	$T_j = 25^\circ\text{C}$
	V_{OUT2}	14.25	—	15.75	V	$17.5 \text{ V} \leq V_{IN} \leq 30 \text{ V},$ $5 \text{ mA} \leq I_{OUT} \leq 1.0 \text{ A}, P_T \leq 15 \text{ W}$
Line regulation	δV_{OLine1}	—	144	300	mV	$T_j = 25^\circ\text{C}, 17.5 \text{ V} \leq V_{IN} \leq 30 \text{ V}$
	δV_{OLine2}	—	48	150	mV	$T_j = 25^\circ\text{C}, 20 \text{ V} \leq V_{IN} \leq 26 \text{ V}$
Load regulation	δV_{OLoad1}	—	144	300	mV	$T_j = 25^\circ\text{C}, 5 \text{ mA} \leq I_{OUT} \leq 1.5 \text{ A}$
	δV_{OLoad2}	—	48	150	mV	$T_j = 25^\circ\text{C}, 250 \text{ mA} \leq I_{OUT} \leq 750 \text{ mA}$
Quiescent current	I_Q	0.8	3.6	7.2	mA	$T_j = 25^\circ\text{C}, I_{OUT} = 0$
Quiescent current change	δI_{Q1}	—	—	1.0	mA	$17.5 \text{ V} \leq V_{IN} \leq 30 \text{ V}$
	δI_{Q2}	—	—	0.5	mA	$5 \text{ mA} \leq I_{OUT} \leq 1.0 \text{ A}$
Voltage drop	V_{drop}	—	2.0	2.5	V	$T_j = 25^\circ\text{C}, I_{OUT} = 1.0 \text{ A}$
Ripple rejection ratio	R_{REJ}	—	58	—	dB	$T_j = 25^\circ\text{C}, f = 10 \text{ kHz}$
Temperature coefficient of output voltage	$\delta V_{OUT}/\delta T_a$	—	-0.8	—	mV/°C	$I_{OUT} = 5 \text{ mA}$
Output noise voltage	V_n	—	300	—	μV_{rms}	$T_j = 25^\circ\text{C}, 10 \text{ Hz} \leq f \leq 100 \text{ kHz}$
Output short circuit current	I_{OS}	—	0.4	—	A	$T_j = 25^\circ\text{C}$
Peak output current	I_{op}	—	2.1	—	A	$T_j = 25^\circ\text{C}$

HA17800V/VP/VPJ Series

HA17818V/VP/VPJ Electrical Characteristics

($V_{IN} = 27\text{ V}$, $I_{OUT} = 500\text{ mA}$, $0^\circ\text{C} \leq T_j \leq 125^\circ\text{C}$, $C_{IN} = 0.33\ \mu\text{F}$, $C_{OUT} = 0.1\ \mu\text{F}$)

Item	Symbol	Min	Typ	Max	Unit	Test Conditions
Output voltage	V_{OUT1}	17.3	18.0	18.7	V	$T_j = 25^\circ\text{C}$
	V_{OUT2}	17.1	—	18.9	V	$21\text{ V} \leq V_{IN} \leq 33\text{ V}$, $5\text{ mA} \leq I_{OUT} \leq 1.0\text{ A}$, $P_T \leq 15\text{ W}$
Line regulation	δV_{OLine1}	—	195	360	mV	$T_j = 25^\circ\text{C}$, $21\text{ V} \leq V_{IN} \leq 33\text{ V}$
	δV_{OLine2}	—	65	180	mV	$T_j = 25^\circ\text{C}$, $24\text{ V} \leq V_{IN} \leq 30\text{ V}$
Load regulation	δV_{OLoad1}	—	195	360	mV	$T_j = 25^\circ\text{C}$, $5\text{ mA} \leq I_{OUT} \leq 1.5\text{ A}$
	δdV_{OLoad2}	—	65	180	mV	$T_j = 25^\circ\text{C}$, $250\text{ mA} \leq I_{OUT} \leq 750\text{ mA}$
Quiescent current	I_Q	0.8	3.6	7.2	mA	$T_j = 25^\circ\text{C}$, $I_{OUT} = 0$
Quiescent current change	δI_{Q1}	—	—	1.0	mA	$21\text{ V} \leq V_{IN} \leq 33\text{ V}$
	δI_{Q2}	—	—	0.5	mA	$5\text{ mA} \leq I_{OUT} \leq 1.0\text{ A}$
Voltage drop	V_{drop}	—	2.0	2.5	V	$T_j = 25^\circ\text{C}$, $I_{OUT} = 1.0\text{ A}$
Ripple rejection ratio	R_{REJ}	—	56	—	dB	$T_j = 25^\circ\text{C}$, $f = 10\text{ kHz}$
Temperature coefficient of output voltage	$\delta V_{OUT}/\delta T_a$	—	-0.8	—	mV/°C	$I_{OUT} = 5\text{ mA}$
Output noise voltage	V_n	—	430	—	μV_{rms}	$T_j = 25^\circ\text{C}$, $10\text{ Hz} \leq f \leq 100\text{ kHz}$
Output short circuit current	I_{OS}	—	0.35	—	A	$T_j = 25^\circ\text{C}$
Peak output current	I_{op}	—	2.1	—	A	$T_j = 25^\circ\text{C}$

HA17824V/VP/VPJ Electrical Characteristics
 $(V_{IN} = 33 \text{ V}, I_{OUT} = 500 \text{ mA}, 0^\circ\text{C} \leq T_j \leq 125^\circ\text{C}, C_{IN} = 0.33 \mu\text{F}, C_{OUT} = 0.1 \mu\text{F})$

Item	Symbol	Min	Typ	Max	Unit	Test Conditions
Output voltage	V_{OUT1}	23.0	24.0	25.0	V	$T_j = 25^\circ\text{C}$
	V_{OUT2}	22.8	—	25.2	V	$27 \text{ V} \leq V_{IN} \leq 38 \text{ V},$ $5 \text{ mA} \leq I_{OUT} \leq 1.0 \text{ A}, P_T \leq 15 \text{ W}$
Line regulation	δV_{OLine1}	—	260	480	mV	$T_j = 25^\circ\text{C}, 27 \text{ V} \leq V_{IN} \leq 38 \text{ V}$
	δV_{OLine2}	—	86	240	mV	$T_j = 25^\circ\text{C}, 30 \text{ V} \leq V_{IN} \leq 36 \text{ V}$
Load regulation	δV_{OLoad1}	—	260	480	mV	$T_j = 25^\circ\text{C}, 5 \text{ mA} \leq I_{OUT} \leq 1.5 \text{ A}$
	δV_{OLoad2}	—	86	240	mV	$T_j = 25^\circ\text{C}, 250 \text{ mA} \leq I_{OUT} \leq 750 \text{ mA}$
Quiescent current	I_Q	0.8	3.7	7.4	mA	$T_j = 25^\circ\text{C}, I_{OUT} = 0$
Quiescent current change	δI_{Q1}	—	—	1.0	mA	$27 \text{ V} \leq V_{IN} \leq 38 \text{ V}$
	δI_{Q2}	—	—	0.5	mA	$5 \text{ mA} \leq I_{OUT} \leq 1.0 \text{ A}$
Voltage drop	V_{drop}	—	2.0	2.5	V	$T_j = 25^\circ\text{C}, I_{OUT} = 1.0 \text{ A}$
Ripple rejection ratio	R_{REJ}	—	50	—	dB	$T_j = 25^\circ\text{C}, f = 10 \text{ kHz}$
Temperature coefficient of output voltage	$\delta V_{OUT}/\delta T_a$	—	-1.2	—	mV/°C	$I_{OUT} = 5 \text{ mA}$
Output noise voltage	V_n	—	570	—	μV_{rms}	$T_j = 25^\circ\text{C}, 10 \text{ Hz} \leq f \leq 100 \text{ kHz}$
Output short circuit current	I_{OS}	—	0.25	—	A	$T_j = 25^\circ\text{C}$
Peak output current	I_{op}	—	2.0	—	A	$T_j = 25^\circ\text{C}$

Characteristic Curves

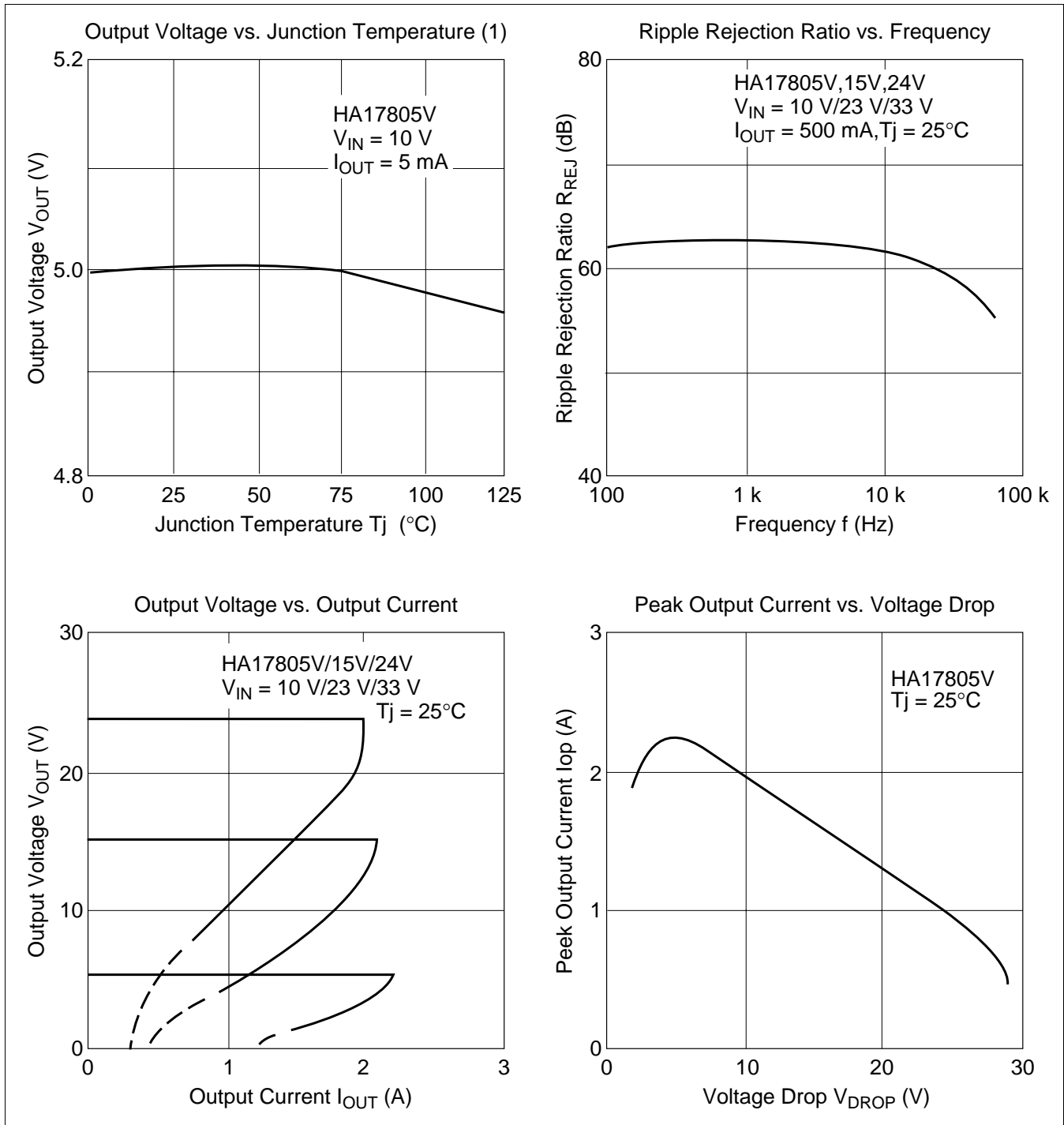

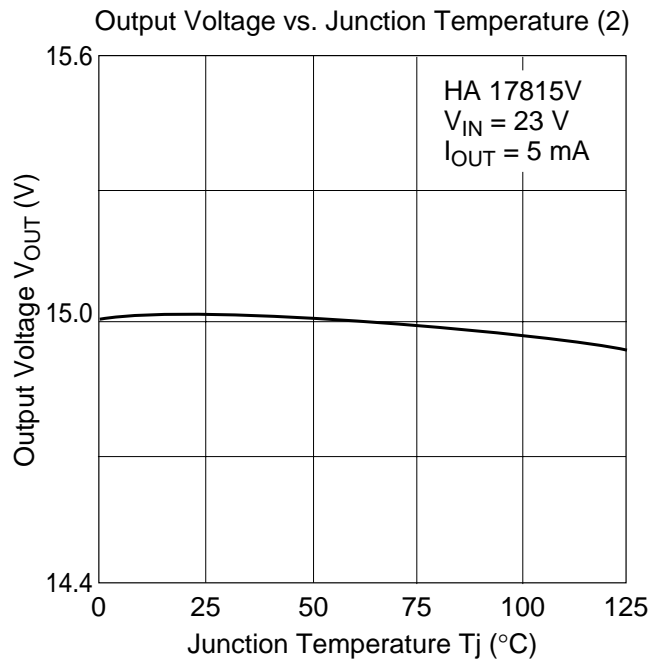
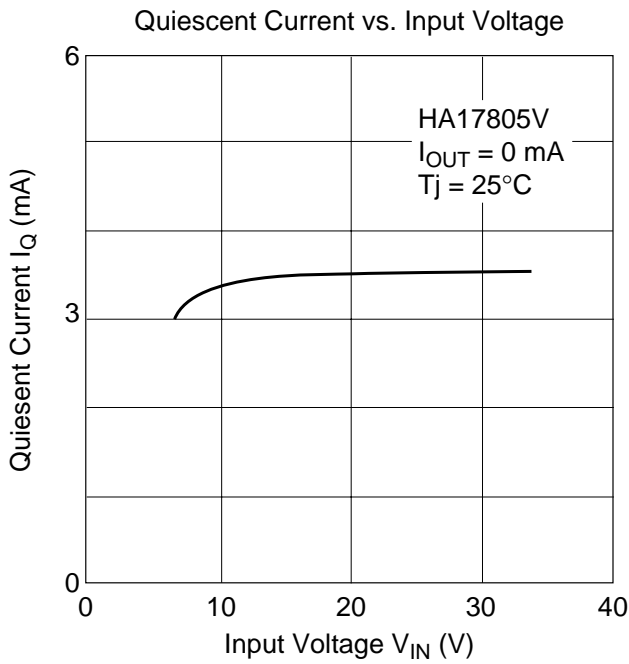
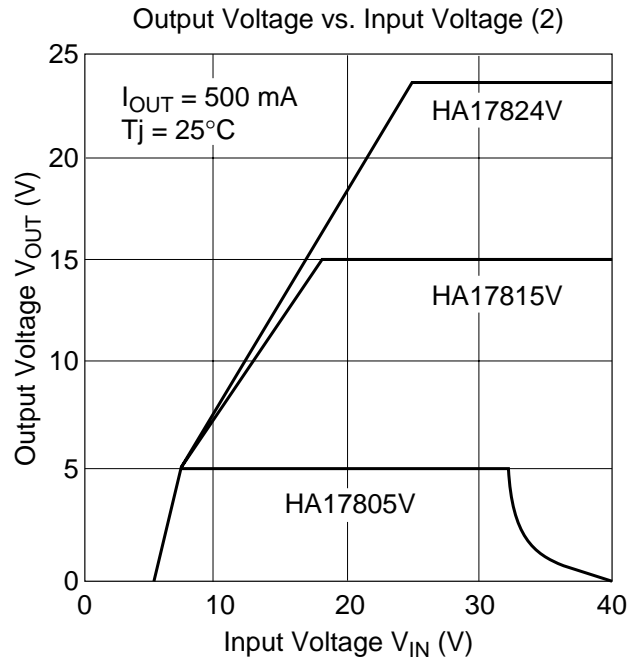
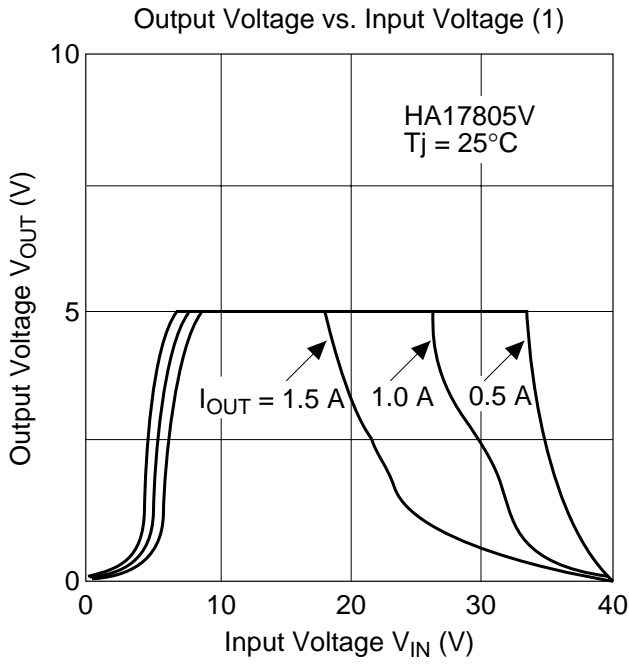

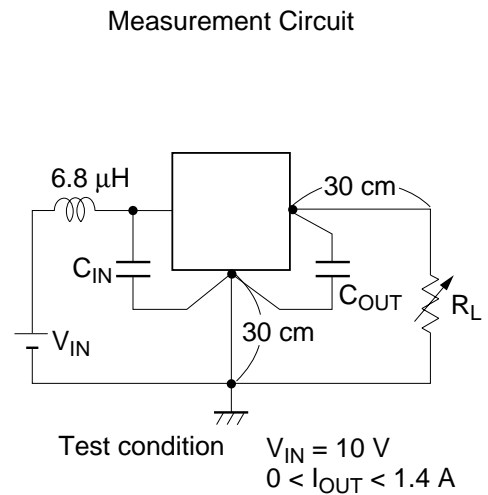
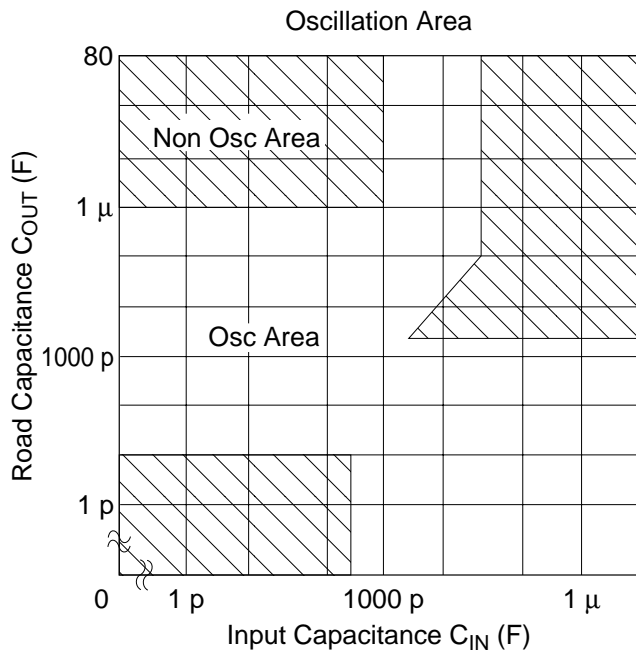
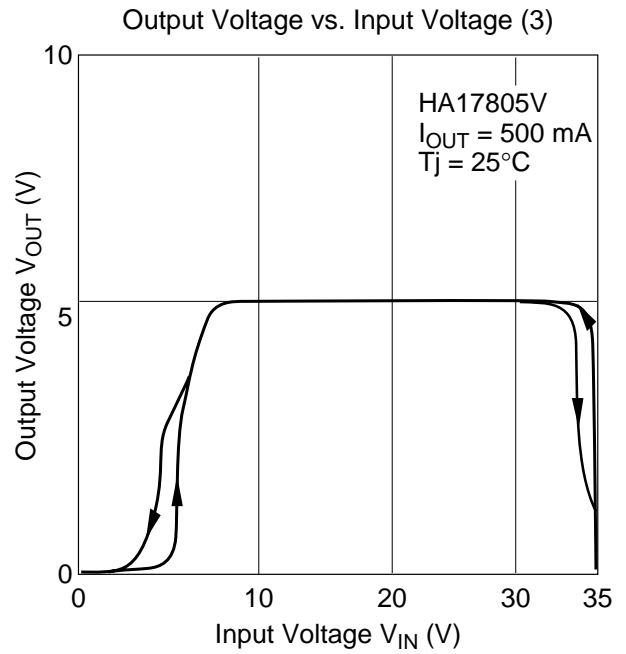
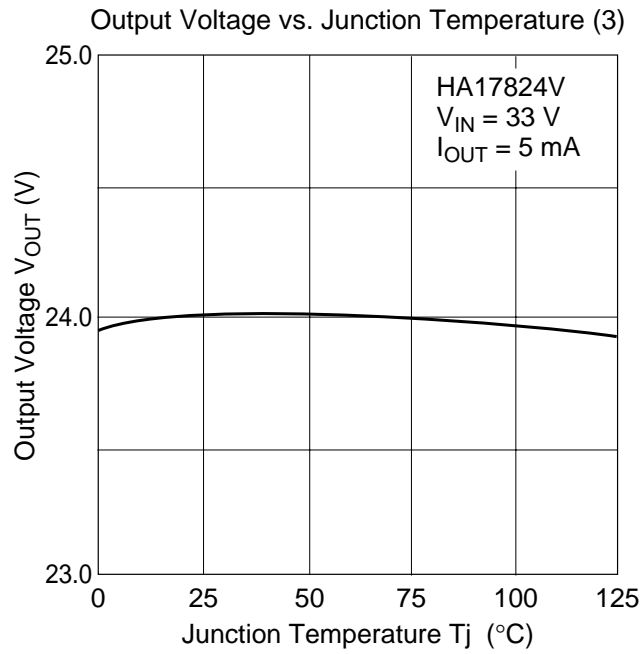

Package Dimensions

Unit: mm

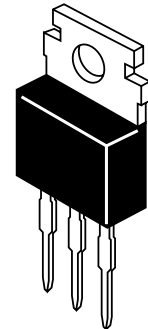
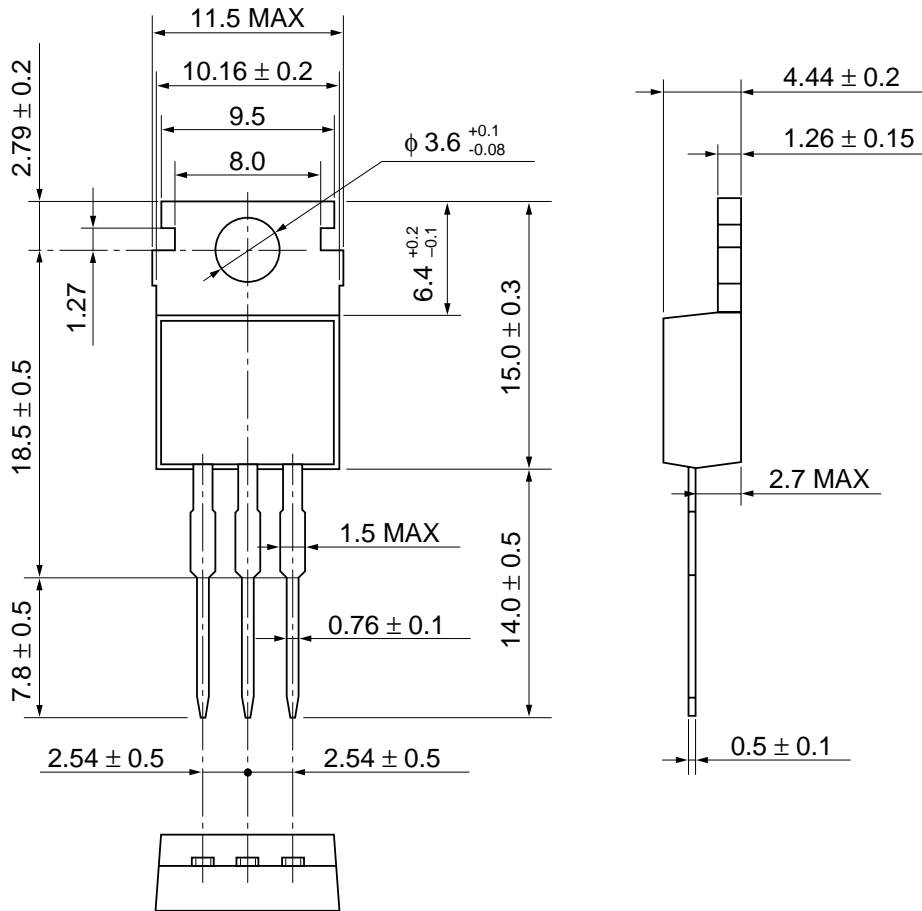

Hitachi Code	TO-220AB
JEDEC	Conforms
EIAJ	Conforms
Mass (reference value)	1.8 g

Cautions

1. Hitachi neither warrants nor grants licenses of any rights of Hitachi's or any third party's patent, copyright, trademark, or other intellectual property rights for information contained in this document. Hitachi bears no responsibility for problems that may arise with third party's rights, including intellectual property rights, in connection with use of the information contained in this document.
2. Products and product specifications may be subject to change without notice. Confirm that you have received the latest product standards or specifications before final design, purchase or use.
3. Hitachi makes every attempt to ensure that its products are of high quality and reliability. However, contact Hitachi's sales office before using the product in an application that demands especially high quality and reliability or where its failure or malfunction may directly threaten human life or cause risk of bodily injury, such as aerospace, aeronautics, nuclear power, combustion control, transportation, traffic, safety equipment or medical equipment for life support.
4. Design your application so that the product is used within the ranges guaranteed by Hitachi particularly for maximum rating, operating supply voltage range, heat radiation characteristics, installation conditions and other characteristics. Hitachi bears no responsibility for failure or damage when used beyond the guaranteed ranges. Even within the guaranteed ranges, consider normally foreseeable failure rates or failure modes in semiconductor devices and employ systemic measures such as fail-safes, so that the equipment incorporating Hitachi product does not cause bodily injury, fire or other consequential damage due to operation of the Hitachi product.
5. This product is not designed to be radiation resistant.
6. No one is permitted to reproduce or duplicate, in any form, the whole or part of this document without written approval from Hitachi.
7. Contact Hitachi's sales office for any questions regarding this document or Hitachi semiconductor products.

HITACHI

Hitachi, Ltd.

Semiconductor & Integrated Circuits.

Nippon Bldg., 2-6-2, Ohte-machi, Chiyoda-ku, Tokyo 100-0004, Japan

Tel: Tokyo (03) 3270-2111 Fax: (03) 3270-5109

URL NorthAmerica : <http://semiconductor.hitachi.com/>
 Europe : <http://www.hitachi-eu.com/hel/ecg>
 Asia (Singapore) : <http://www.has.hitachi.com.sg/grp3/sicd/index.htm>
 Asia (Taiwan) : http://www.hitachi.com.tw/E/Product/SICD_Frame.htm
 Asia (HongKong) : <http://www.hitachi.com.hk/eng/bo/grp3/index.htm>
 Japan : <http://www.hitachi.co.jp/Sicd/indx.htm>

For further information write to:

Hitachi Semiconductor
(America) Inc.
179 East Tasman Drive,
San Jose, CA 95134
Tel: <1> (408) 433-1990
Fax: <1> (408) 433-0223

Hitachi Europe GmbH
Electronic components Group
Dornacher Straße 3
D-85622 Feldkirchen, Munich
Germany
Tel: <49> (89) 9 9180-0
Fax: <49> (89) 9 29 30 00

Hitachi Europe Ltd.
Electronic Components Group.
Whitebrook Park
Lower Cookham Road
Maidenhead
Berkshire SL6 8YA, United Kingdom
Tel: <44> (1628) 585000
Fax: <44> (1628) 778322

Hitachi Asia Pte. Ltd.
16 Collyer Quay #20-00
Hitachi Tower
Singapore 049318
Tel: 535-2100
Fax: 535-1533

Hitachi Asia Ltd.
Taipei Branch Office
3F, Hung Kuo Building, No.167,
Tun-Hwa North Road, Taipei (105)
Tel: <886> (2) 2718-3666
Fax: <886> (2) 2718-8180

Hitachi Asia (Hong Kong) Ltd.
Group III (Electronic Components)
7/F., North Tower, World Finance Centre,
Harbour City, Canton Road, Tsim Sha Tsui,
Kowloon, Hong Kong
Tel: <852> (2) 735 9218
Fax: <852> (2) 730 0281
Telex: 40815 HITEC HX

Copyright ' Hitachi, Ltd., 1998. All rights reserved. Printed in Japan.

HITACHI