

Americas

147 Central Avenue  
Hackensack, NJ 07601  
(201) 489-8989  
[www.cml-it.com](http://www.cml-it.com)

Europe

Robert Bunsen Str. 1  
D-67098 Bad Dürkheim  
+49 (6322) 9567-0  
[www.cml-it.com](http://www.cml-it.com)

---

***CMDA52xx15D13L Series Power LED (5 Watt) on Star PCB***  
***CMDA53xx15D13L Series Power LED (5 Watt) on Square PCB***

**- Features**

- Super high flux output and high luminance
- Designed for high current operation
- Low thermal resistance
- SMT solder compatible
- Lead (Pb) Free Product – RoHS Compliant

**- Applications**

- General Illumination
  - Outdoor & Indoor Architectural Lighting
  - Decorative Lighting
  - Portable Lighting / Flash Light (Torch) Lamps
  - Reading Lamps and Task Lighting
  - Traffic Signaling

**- Description**

These packaged LED's on metal PCB's are designed for high current operation and high flux output applications. The package design features better thermal management characteristics than other LED solutions. Because of these advantages, this product has many applications such as internal & external lighting, automobile lighting, large size LCD backlight, etc.



**CML**

**INNOVATIVE TECHNOLOGIES, INC.**

**WHERE INNOVATION COMES TO LIGHT**

Americas

147 Central Avenue  
Hackensack, NJ 07601  
(201) 489-8989  
[www.cml-it.com](http://www.cml-it.com)

Europe

Robert Bunsen Str. 1  
D-67098 Bad Durkheim  
+49 (6322) 9567-0  
[www.cml-it.com](http://www.cml-it.com)

**1. Outline Dimensions**

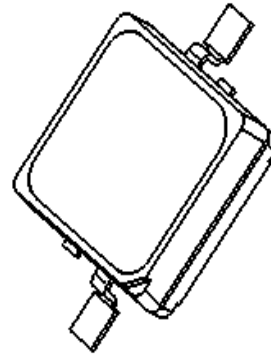
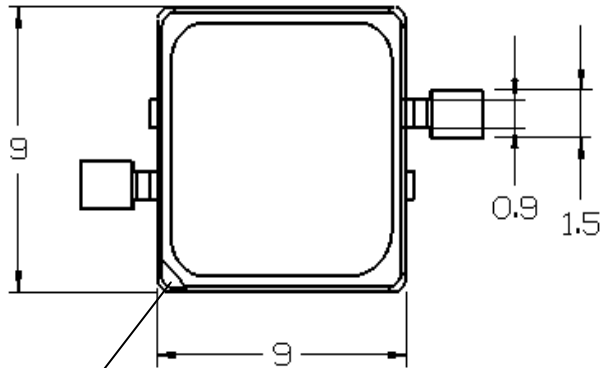

Isometric view  
Scale: None

Cathode  
Mark

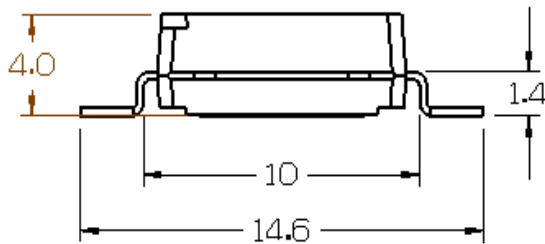

Slug (+)

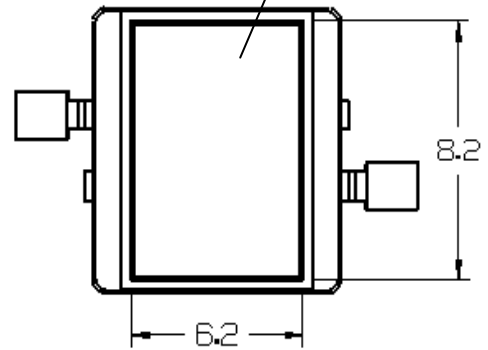

Rear view

- Notes : 1. All dimensions are in millimeters.
- 2. Scale : none
- 3. This drawing is reference only for engineering

## 2. Metal Outline Dimensions

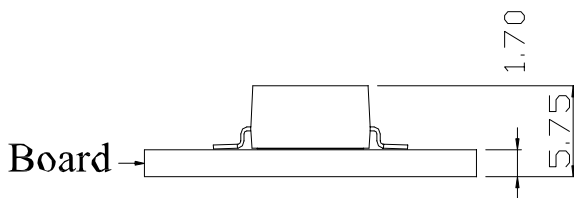
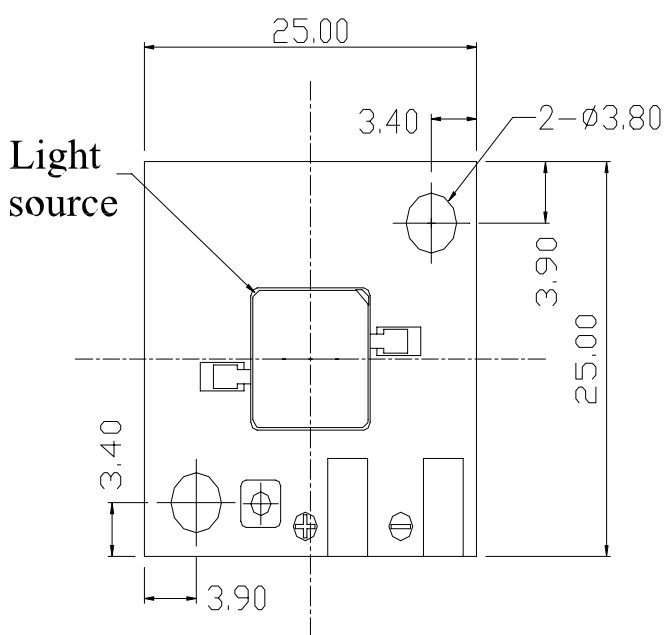

**CMDA53xx15D13L**  
Square Configuration

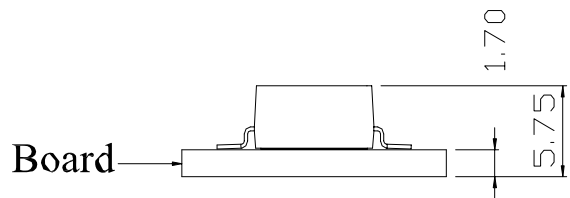
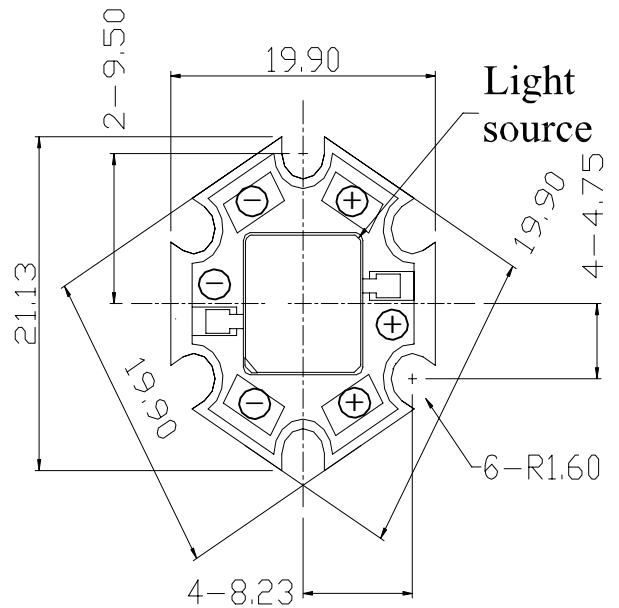

**CMDA52xx15D13L**  
Star Configuration

- Note : 1. All dimensions are in millimeters  
 2. Scale : none  
 3. This drawing is reference only engineering.

**Americas**

 147 Central Avenue  
 Hackensack, NJ 07601  
 (201) 489-8989  
[www.cml-it.com](http://www.cml-it.com)
**Europe**

 Robert Bunsen Str. 1  
 D-67098 Bad Durkheim  
 +49 (6322) 9567-0  
[www.cml-it.com](http://www.cml-it.com)
**3. Electro-Optical Characteristics (at IF=350mA, TA=25°C)**
**CMDA52xx15D13L Star PCB series**

P/N	Description	Luminous Flux Min./Typ. (lm)	Correlated Color Temperature (Kelvin)	CRI	Dominant Wavelength (nm) Min./Typ./Max.	Forward Voltage (volts) Min./Typ./Max.	View Angle (degrees)	Thermal resistance (°C /W)
	Symbol	ΦV [1]	CCT [3]	Ra	λD	V	2Θ 1/2	Rθ [4]
CMDA52CW15D13L	Pure White	154 / 178	6500	70		3.0 / 3.5 / 4.0	110	4
CMDA52WW15D13L	Warm White	91 / 120	3000	80		3.0 / 3.5 / 4.0	110	4
CMDA52CB15D13L	Blue	24 / 30			455 / 460 / 475	3.0 / 3.5 / 4.0	130	4
CMDA52AG15D13L	Green	118 / 189			520 / 527 / 535	3.0 / 3.5 / 4.0	130	4
CMDA52AR15D13L	Red	91 / 114			620 / 625 / 630	2.0 / 2.5 / 3.0	128	6
CMDA52GB15D13L	Cyan	118 / 150			500 / 505 / 510	3.0 / 3.5 / 4.0	130	4
CMDA52DY15D13L	Amber	118 / 144			585 / 590 / 595	2.0 / 2.5 / 3.0	128	6

**4. Absolute Maximum Ratings (at TA=25°C)**

P/N	Description	Forward Current (A)	Power Dissipation (Watts)	Junction Temperature (°C)	Operating Temperature (°C)	Storage Temperature (°C)
	Symbol	IF	PD	Tj	Topr	Tstg
CMDA52CW15D13L	Pure White	1.6	6.4	125	-30~+85	-40~+120
CMDA52WW15D13L	Warm White	1.6	6.4	125	-30~+85	-40~+120
CMDA52CB15D13L	Blue	1.6	6.4	125	-30~+85	-40~+120
CMDA52AG15D13L	Green	1.6	6.4	125	-30~+85	-40~+120
CMDA52AR15D13L	Red	1.6	4.8	100	-30~+85	-40~+120
CMDA52GB15D13L	Cyan	1.6	6.4	125	-30~+85	-40~+120
CMDA52DY15D13L	Amber	1.6	4.8	100	-30~+85	-40~+120

**\*Notes:**

- [1] ΦV is the total luminous flux output as measured with an integrating sphere.  
 [2] Zener diode chip included to protect the LED from ESD.  
 [3] Rθ is measured with a metal core PCB (25 °C ≤TJ ≤ 125 °C).  
 [4] CML maintains a tolerance of ± 10% on flux and power measurements.  
 [5] CCT ± 5% tester tolerance.  
 [6] Color Coordinate Measurement allowance is ± 0.005  
 [7] A tolerance of ± 0.006V on forward voltage measurements

-----Caution-----  
**Please do not drive at rated current more than 5 sec. without proper heat sink**

Americas

 147 Central Avenue  
 Hackensack, NJ 07601  
 (201) 489-8989  
[www.cml-it.com](http://www.cml-it.com)
Europe

 Robert Bunsen Str. 1  
 D-67098 Bad Durkheim  
 +49 (6322) 9567-0  
[www.cml-it.com](http://www.cml-it.com)
**5. Electro-Optical Characteristics (at IF=350mA, TA=25°C)**
**CMDA53xx15D13L Square PCB series**

P/N	Description	Luminous Flux Min./Typ. (lm)	Correlated Color Temperature (Kelvin)	CRI	Dominant Wavelength (nm) Min./Typ./Max.	Forward Voltage (volts) Min./Typ./Max.	View Angle (degrees)	Thermal resistance (°C /W)
	Symbol	ΦV [1]	CCT [3]	Ra	λD	V	2Θ 1/2	Rθ [4]
CMDA53CW15D13L	Pure White	154 / 178	6500	70		3.0 / 3.5 / 4.0	110	4
CMDA53WW15D13L	Warm White	91 / 120	3000	80		3.0 / 3.5 / 4.0	110	4
CMDA53CB15D13L	Blue	24 / 30			455 / 460 / 475	3.0 / 3.5 / 4.0	130	4
CMDA53AG15D13L	Green	118 / 189			520 / 527 / 535	3.0 / 3.5 / 4.0	130	4
CMDA53AR15D13L	Red	91 / 114			620 / 625 / 630	2.0 / 2.5 / 3.0	128	6
CMDA53GB15D13L	Cyan	118 / 150			500 / 505 / 510	3.0 / 3.5 / 4.0	130	4
CMDA53DY15D13L	Amber	118 / 144			585 / 590 / 595	2.0 / 2.5 / 3.0	128	6

**6. Absolute Maximum Ratings (at TA=25°C)**

P/N	Description	Forward Current (A)	Power Dissipation (Watts)	Junction Temperature (°C)	Operating Temperature (°C)	Storage Temperature (°C)
	Symbol	I <sub>F</sub>	P <sub>D</sub>	T <sub>J</sub>	T <sub>opr</sub>	T <sub>stg</sub>
CMDA53CW15D13L	Pure White	1.6	6.4	125	-30~+85	-40~+120
CMDA53WW15D13L	Warm White	1.6	6.4	125	-30~+85	-40~+120
CMDA53CB15D13L	Blue	1.6	6.4	125	-30~+85	-40~+120
CMDA53AG15D13L	Green	1.6	6.4	125	-30~+85	-40~+120
CMDA53AR15D13L	Red	1.6	4.8	100	-30~+85	-40~+120
CMDA53GB15D13L	Cyan	1.6	6.4	125	-30~+85	-40~+120
CMDA53DY15D13L	Amber	1.6	4.8	100	-30~+85	-40~+120

**\*Notes:**

- [1] ΦV is the total luminous flux output as measured with an integrating sphere.  
 [2] Zener diode chip included to protect the LED from ESD.  
 [3] Rθ is measured with a metal core PCB (25 °C ≤T<sub>J</sub> ≤ 125 °C).  
 [4] CML maintains a tolerance of ± 10% on flux and power measurements.  
 [5] CCT ± 5% tester tolerance.  
 [6] Color Coordinate Measurement allowance is ± 0.005  
 [7] A tolerance of ± 0.006V on forward voltage measurements

-----Caution-----

**Please do not drive at rated current more than 5 sec. without proper heat sink**

### 7. Forward Voltage vs. Forward Current (Ta=25°C)

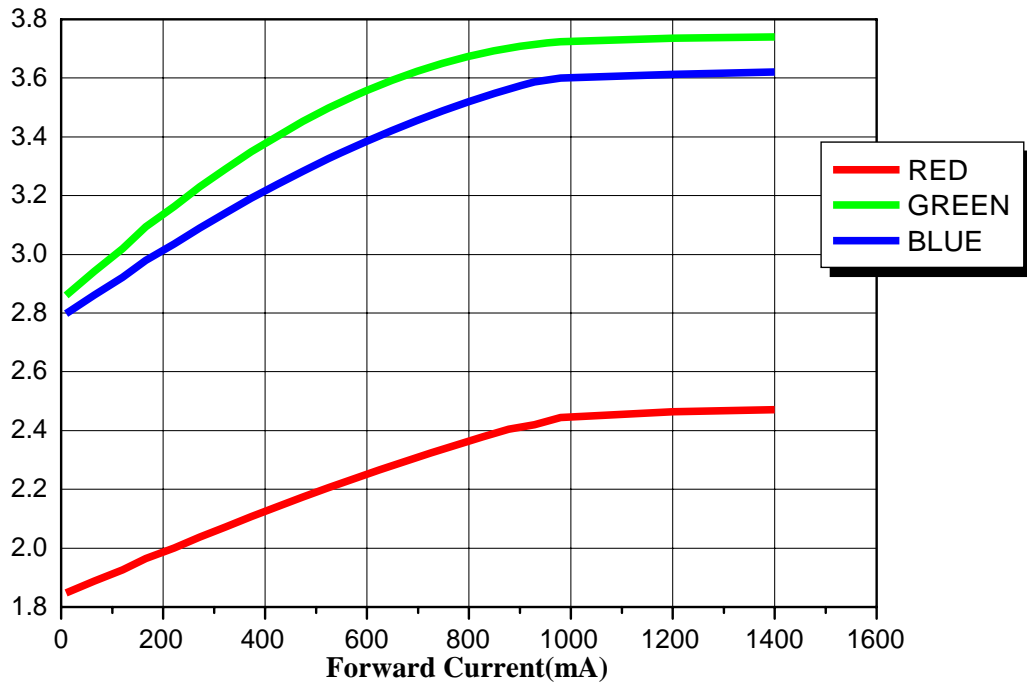

### 8. Forward Current vs. Normalized Relative Luminous Flux (Ta=25°C)

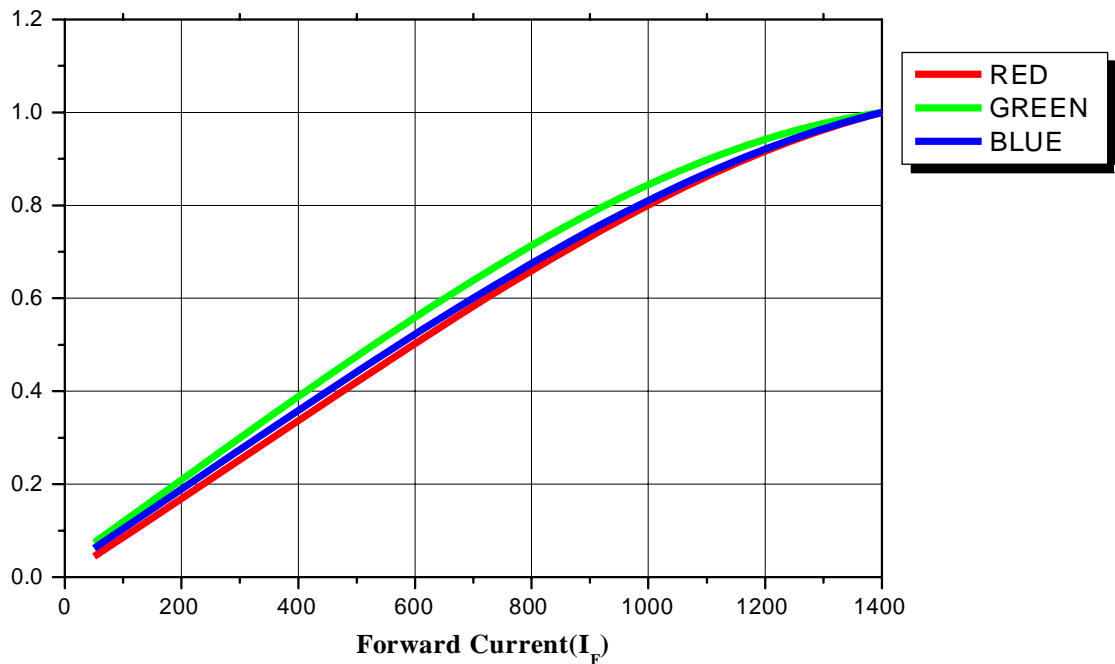

### 9. White Color spectrum of Typical CCT (Ta=25°C)

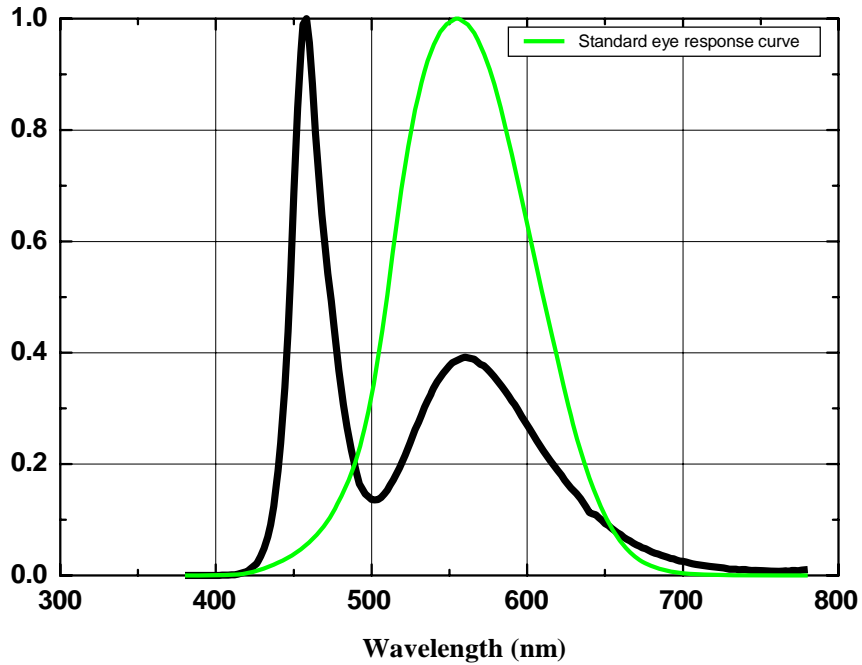

### 10. Warm White spectrum of Typical CCT

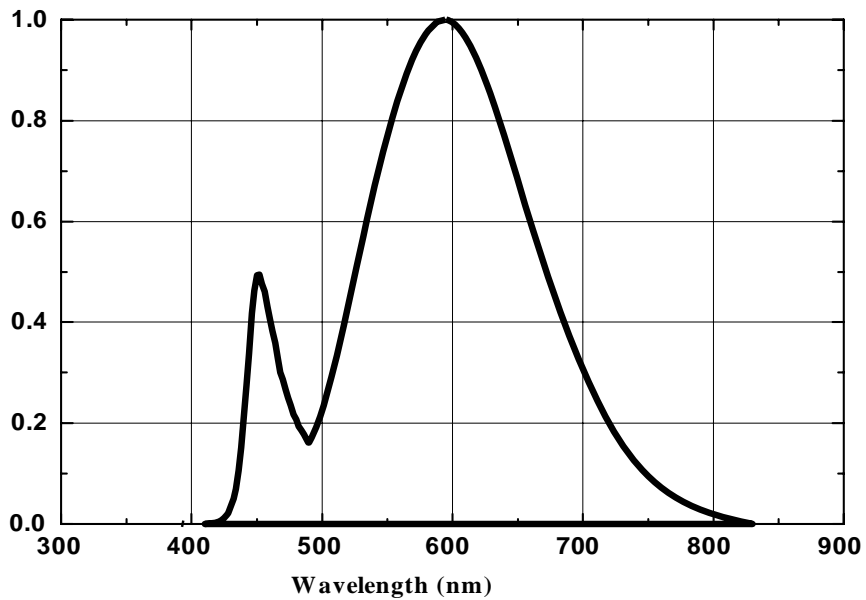

## 11. Spectrum for Red, Green, Blue, Amber, Cyan

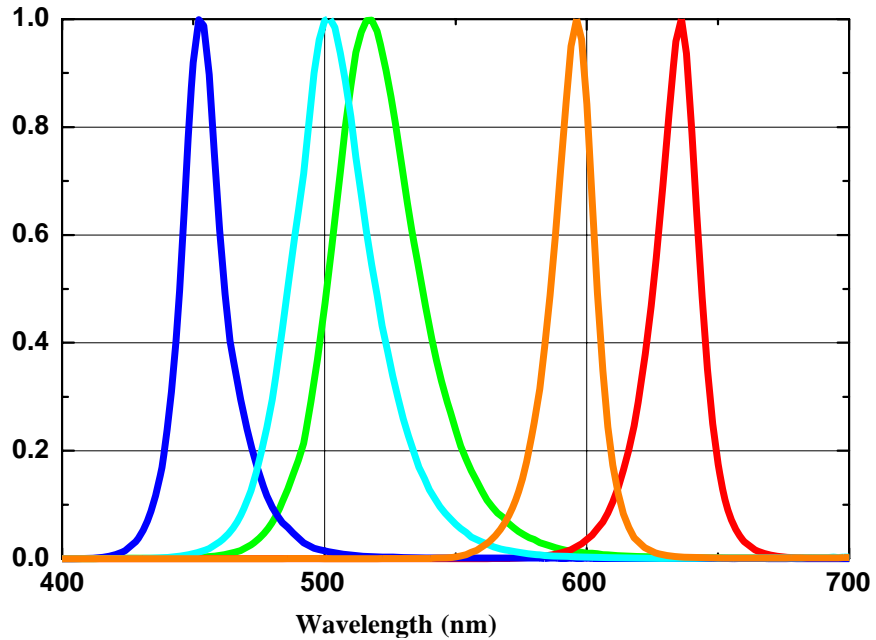

Americas  
147 Central Avenue  
Hackensack, NJ 07601  
(201) 489-8989  
[www.cml-it.com](http://www.cml-it.com)

Europe  
Robert Bunsen Str. 1  
D-67098 Bad Durkheim  
+49 (6322) 9567-0  
[www.cml-it.com](http://www.cml-it.com)



## 12. Radiation pattern for

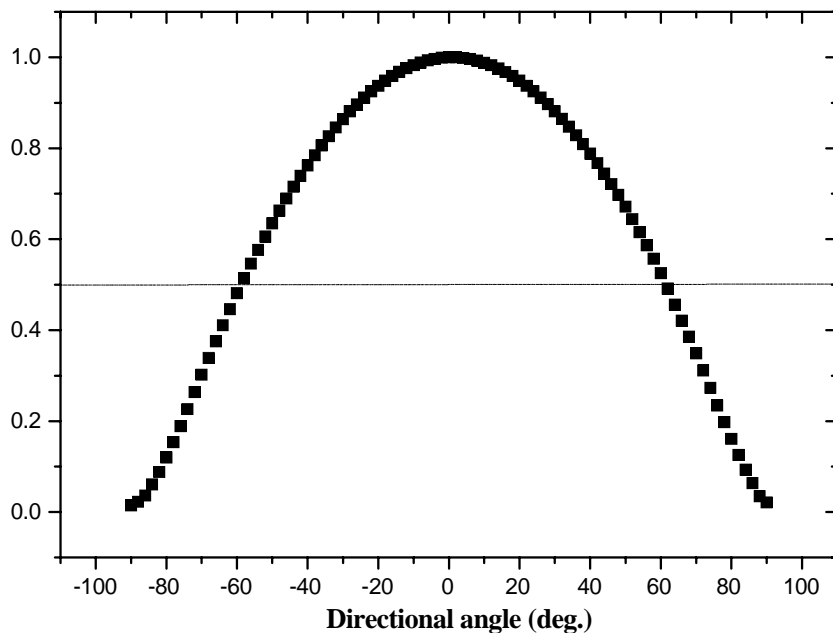

## 13. Radiation pattern for Red

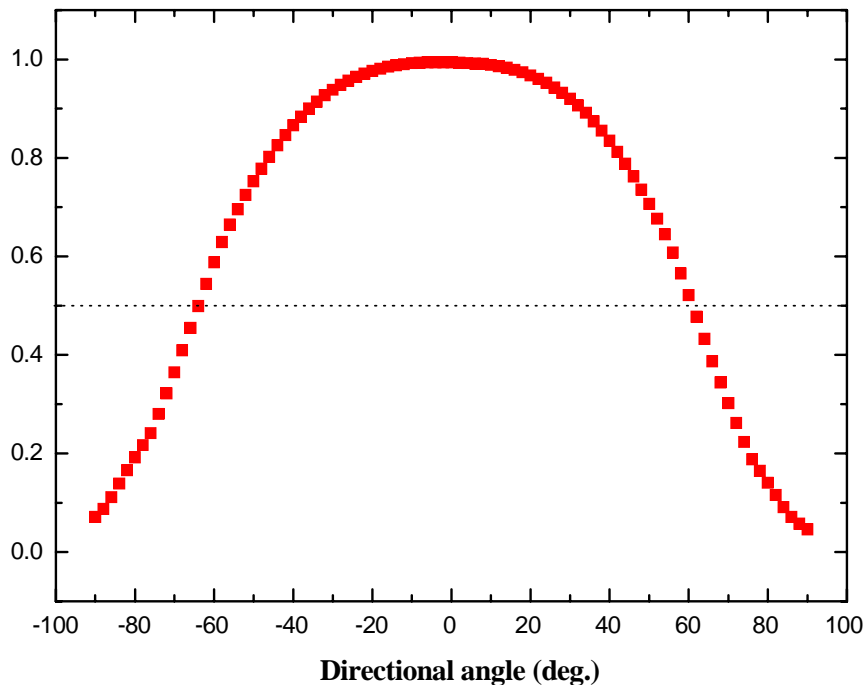

#### 14. Radiation pattern for Green

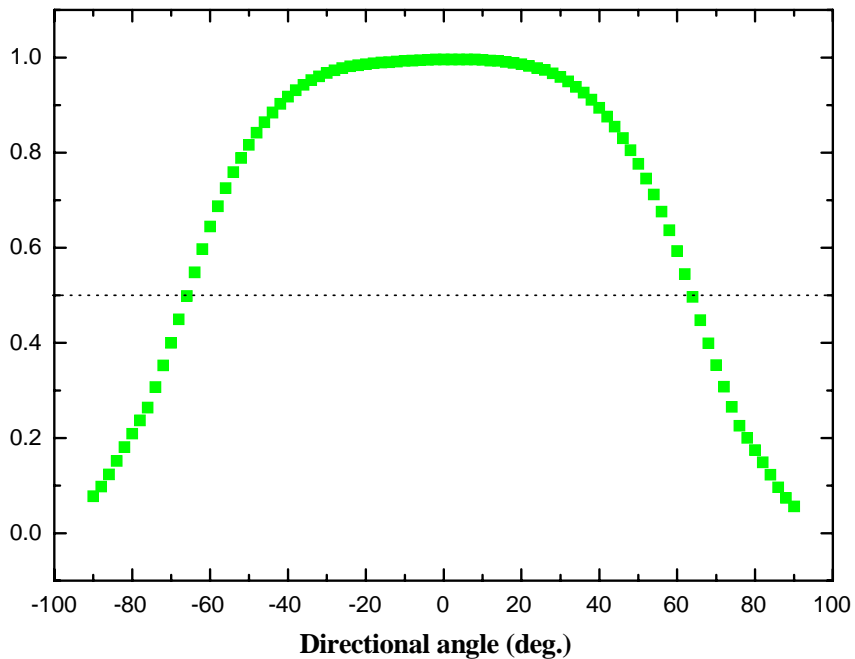

#### 15. Radiation pattern for Blue

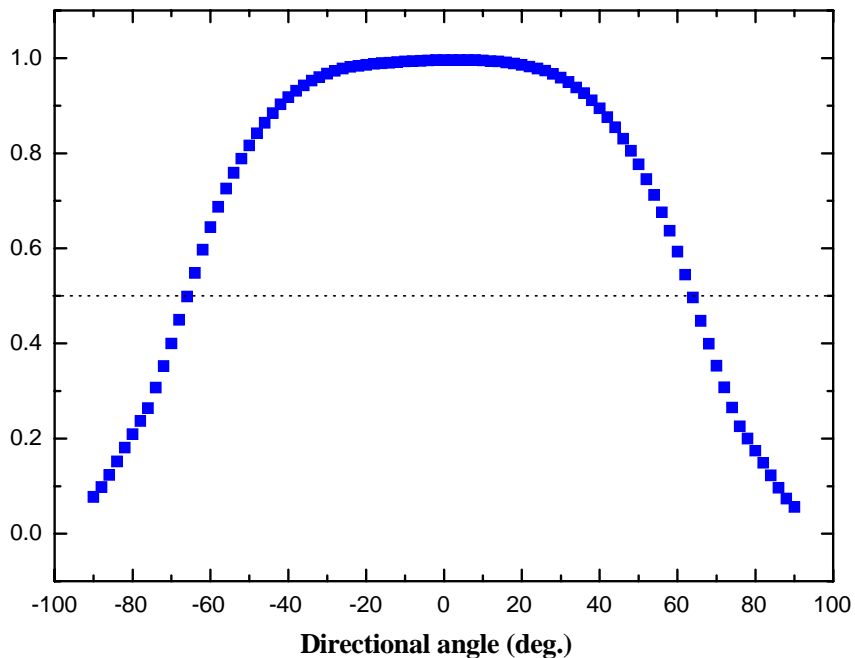

Americas  
147 Central Avenue  
Hackensack, NJ 07601  
(201) 489-8989  
[www.cml-it.com](http://www.cml-it.com)

Europe  
Robert Bunsen Str. 1  
D-67098 Bad Durkheim  
+49 (6322) 9567-0  
[www.cml-it.com](http://www.cml-it.com)

## 16. Radiation pattern for Cyan

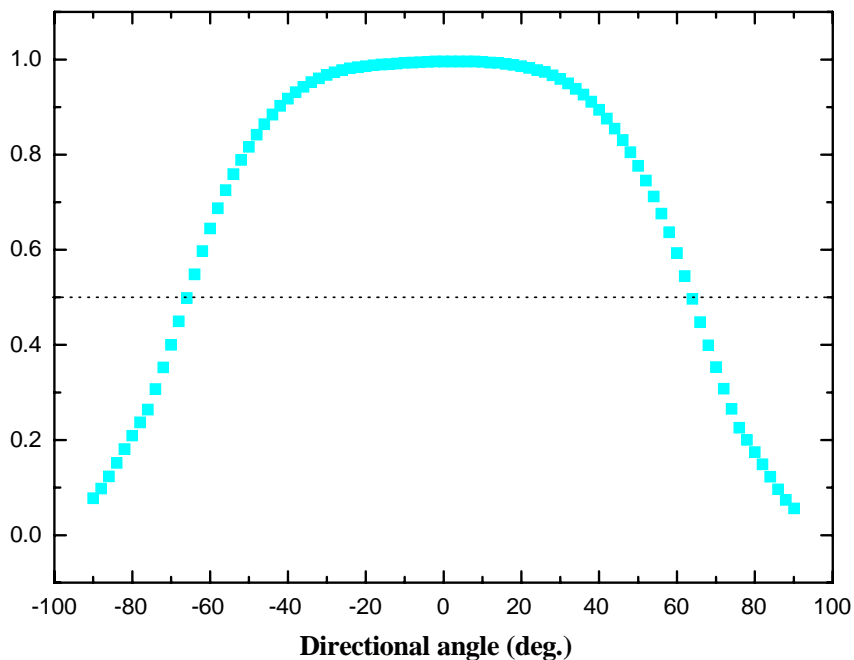

## 17. Radiation pattern for Amber

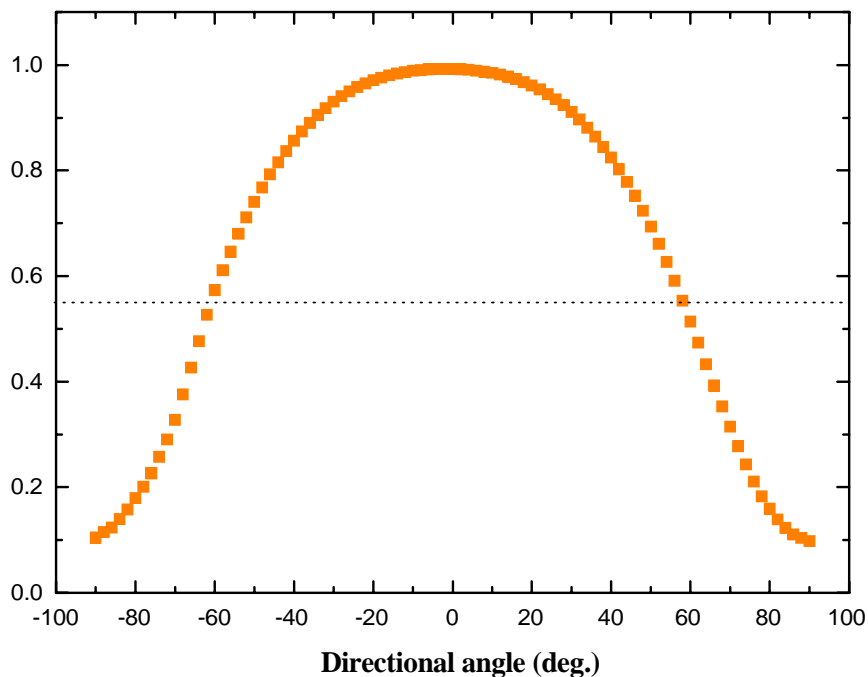

**18. Forward Current vs. Wavelength shift (Ta=25°C)**

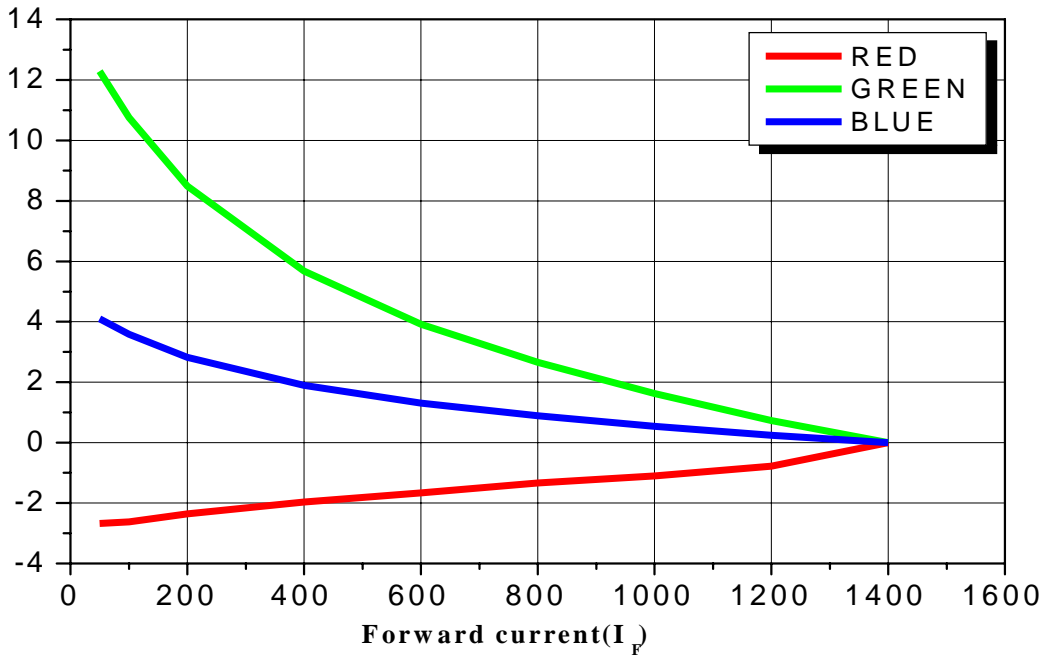

**19. Temperature of Junction vs. Relative Light Output for Blue, Green, Red (Ta=25°C)**

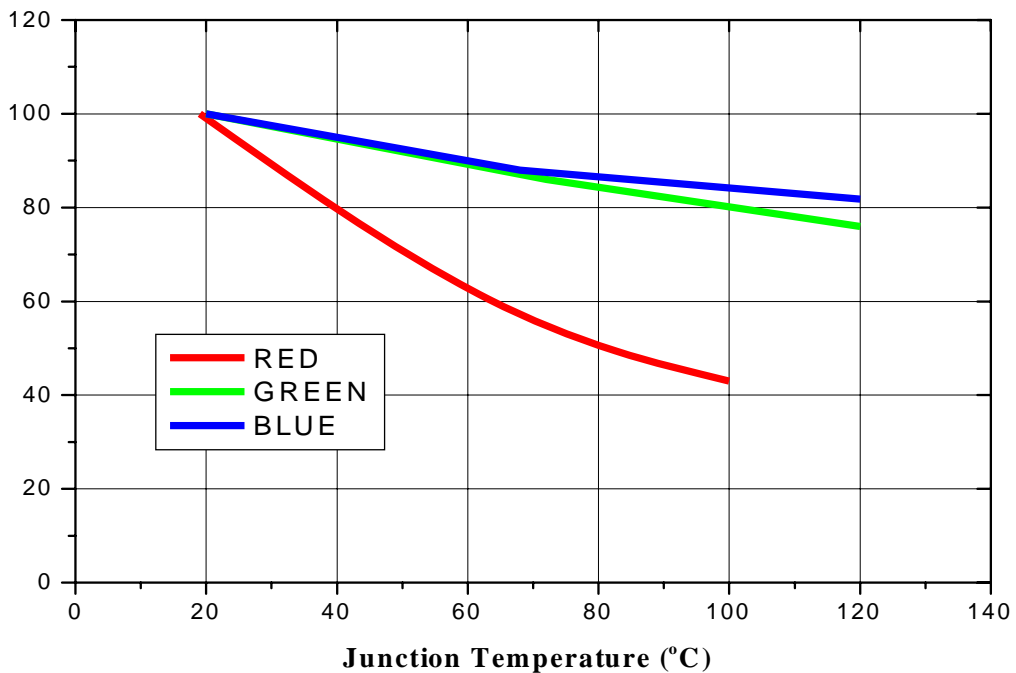

## 20. Ambient Temperature vs. Allowable Forward Current for White, Blue, Green, Cyan

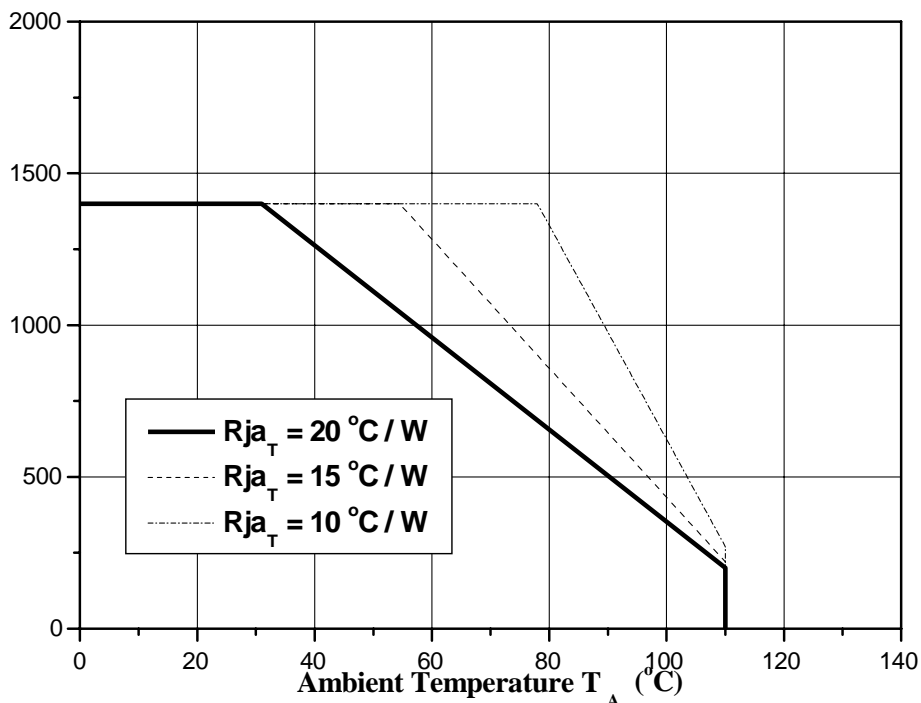

## 21. Ambient Temperature vs. Allowable Forward Current for Red, Amber

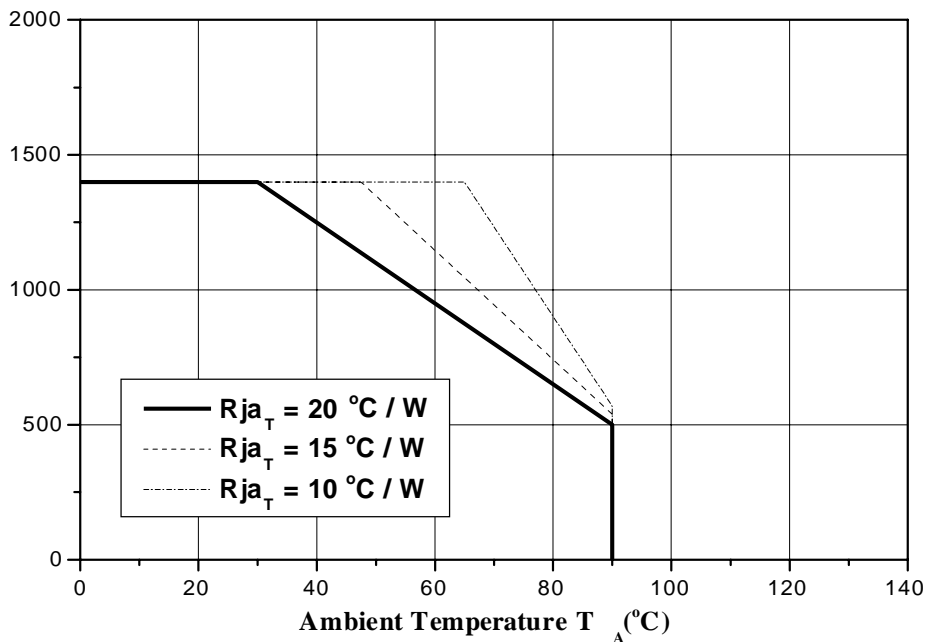

## 22. Reel Packaging Dimensions (Star type)

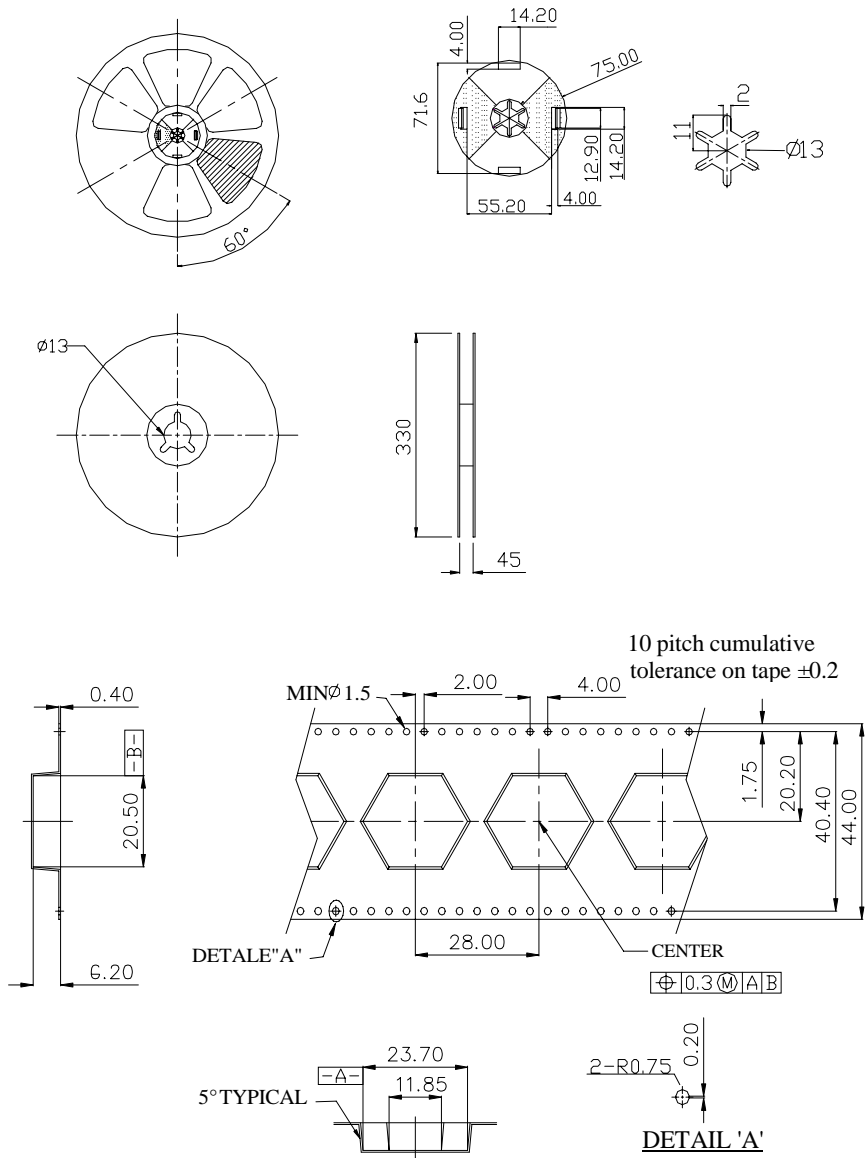

Note : 1. The number of loaded products in the reel is 100 pieces

2. All dimensions are in millimeters

3. Scale : none

4. This drawing is reference only engineering

## 23. Reel Packaging Dimensions (Square type)

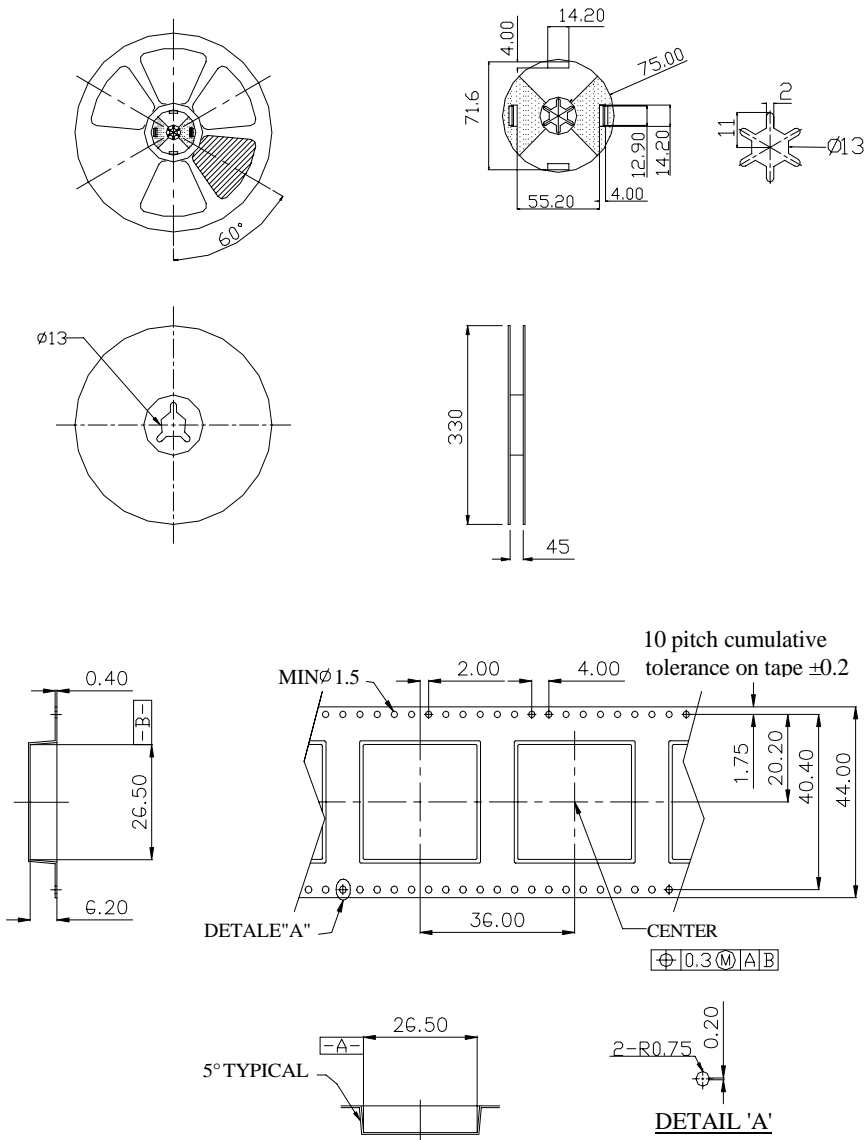

- Note : 1. The number of loaded products in the reel is 100 pieces
2. All dimensions are in millimeters
  3. Scale is none
  4. This is drawing is reference only engineering

## 24. Recommended soldering

### 1) Solder pad

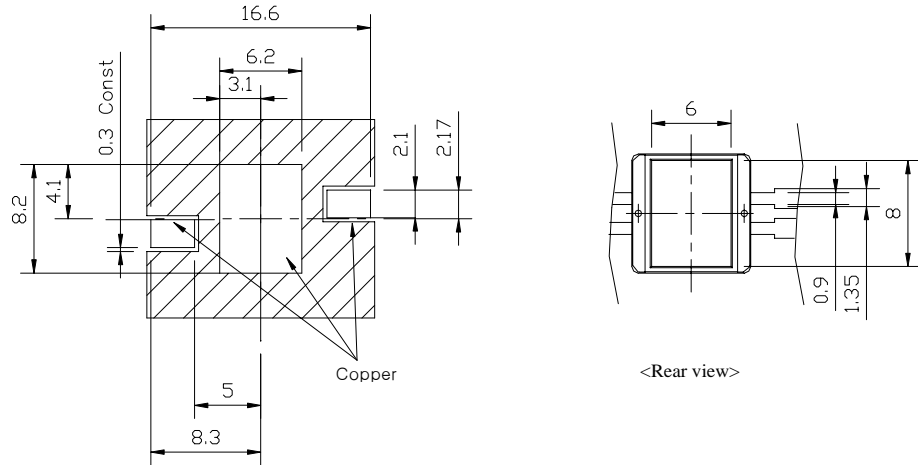
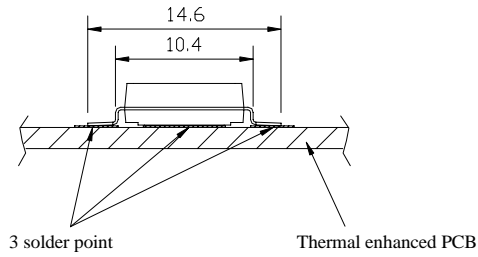

### 2) Solder paste pattern

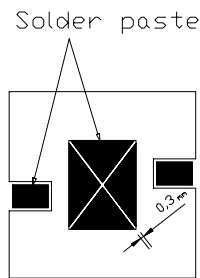

Note : 1. Paste thickness : 0.2mm



## 25. Soldering Profile ( $T_a=25^{\circ}\text{C} \pm 5$ / $\text{RH}=35\% \pm 5$ )

### (1) Reflow Soldering Conditions / Profile

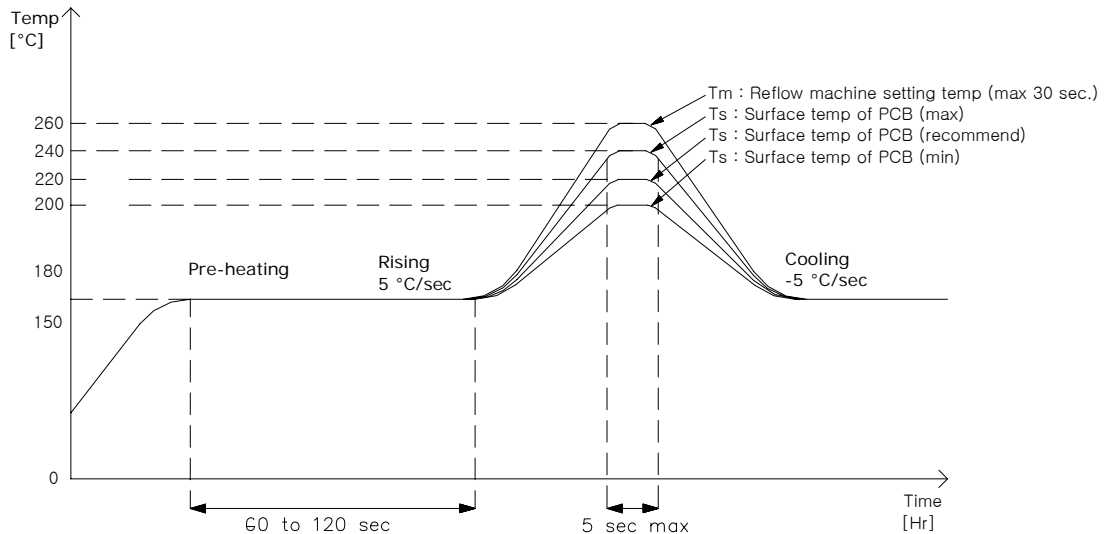

### (2) Hand Soldering conditions

- Lead : Not more than 3 seconds @ MAX 280 °C
- Slug : Use a thermal-adhesives

#### \* Caution

1. Reflow soldering should not be done more than one time.
2. Repairing should not be done after the LED's have been soldered. When repairing is unavoidable, suitable tools must be used.
3. Die slug is to be soldered.
4. When soldering, do not put stress on the LED's during heating.
5. After soldering, do not warp the circuit board.
6. Recommend to use a convection type reflow machine with 7 ~ 8 zones.