

# HA11227/HA12018

## PLL FM Demodulator for Portable and Car Radio

HITACHI HA11227 and HA12018 have been developed as the Phase Locked Loop system FM Demodulators for car radio. HA11227 is encapsulated in a DIP-16pin, and HA12018 in SIP-16pin (Vertical Plastic Package). These IC's employ the same chips and their functions and features are as follows.

### FUNCTIONS

- Stereo Demodulator
- Automatic ST/Mono Switching Circuit
- Indicator Lamp Driver

### FEATURES

- Phase Locked Loop System
- Wide Operating Supply Voltage Range
- Automatic Stereo/Monaural Switching when supply voltage goes down. No shock noise is generated at ST/Mono switching
- Lamp-lighting corresponds to the ST/Mono switching

HA11227



(SP-16)

HA12018



(DP-16)

### BLOCK DIAGRAM

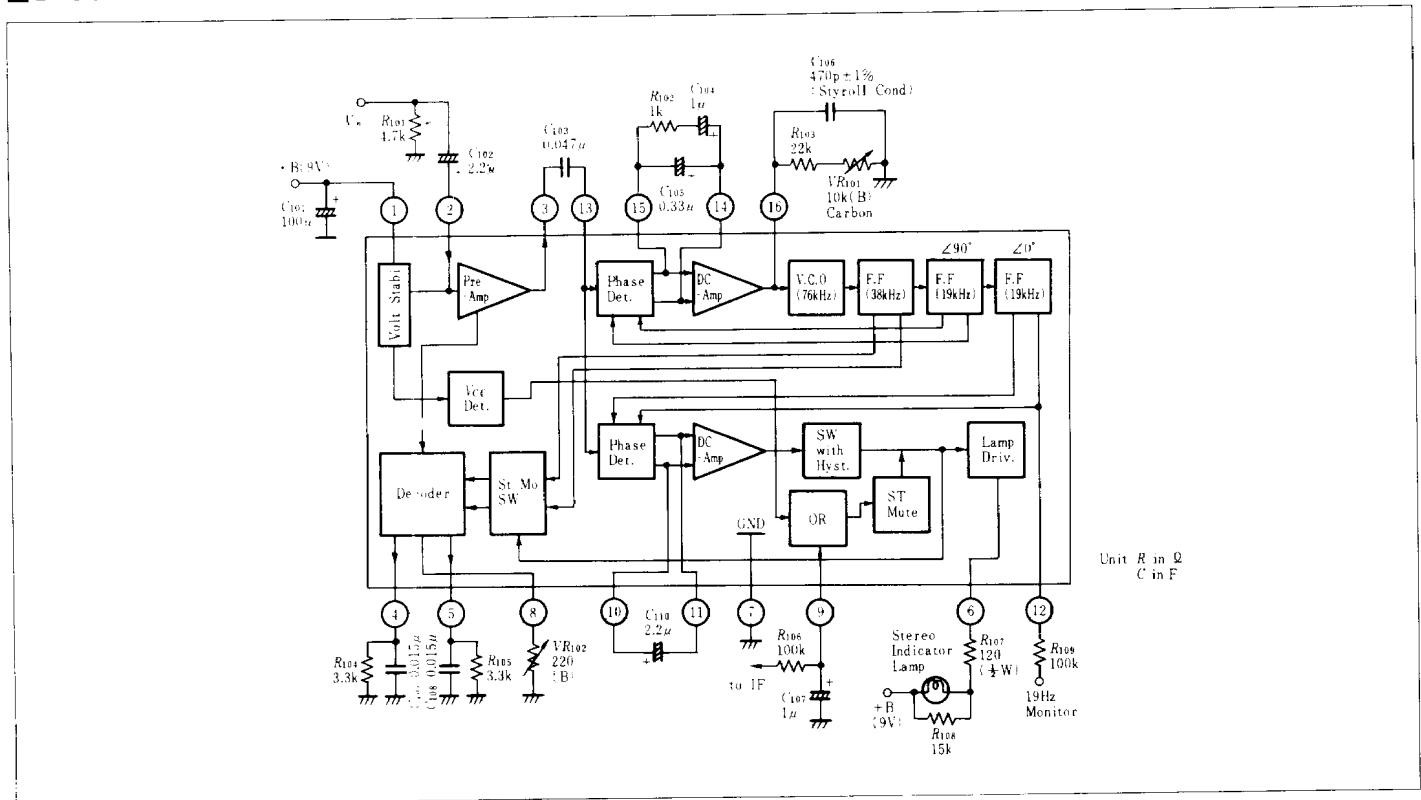

### ABSOLUTE MAXIMUM RATINGS

Item	Symbol	Ratings	Unit
Supply Voltage	$V_{CC}$	16	V
Lamp Driving Current	$I_L$	Constant	75
		Peak	100
Power Dissipation*	$P_T$	400	mW
Operating Temperature	$T_{opr}$	-30 to +75	°C
Storage Temperature	$T_{stg}$	-55 to +125	°C

■ CIRCUIT SCHEMATIC

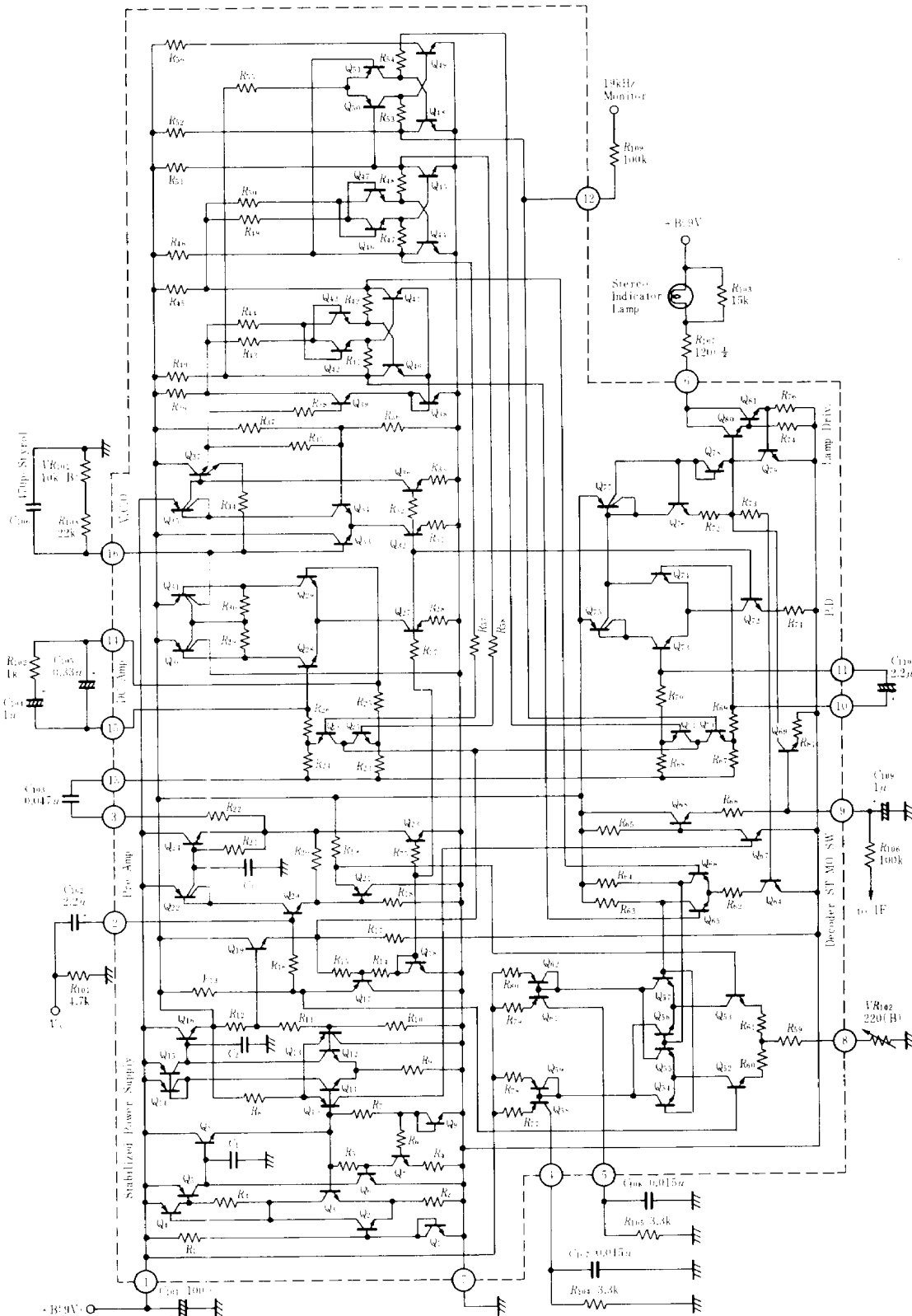



■ PRINTED CIRCUIT BOARD LAYOUT PATTERN

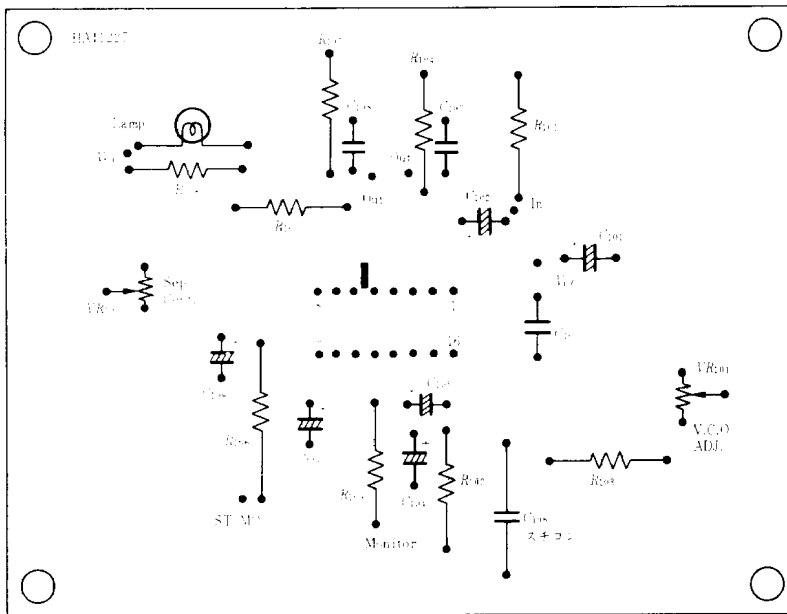

HA11227 Top View

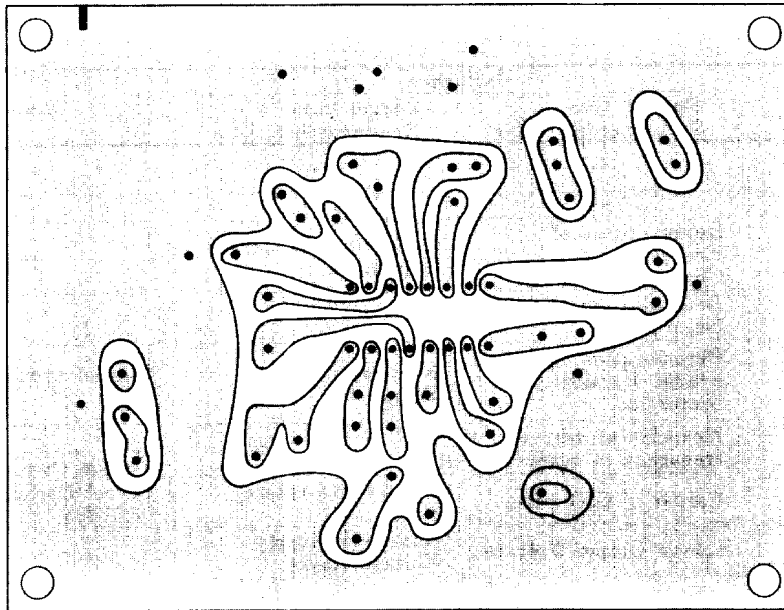

HA11227 Bottom View

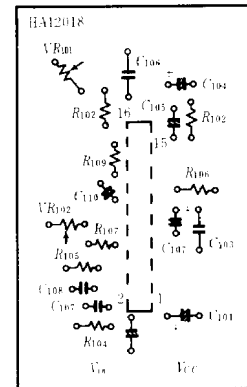

HA12018 Top View

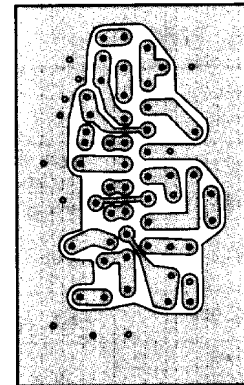

HA12018 Bottom View

■ INITIAL ADJUSTMENT

Under no input signal, adjust the pin-16 external semi-fixed resistance VR<sub>101</sub> (10kΩ) and set 12 pin output to 19kHz±19Hz.

■ SEPARATION ADJUSTMENT

- (1) First, set the Stereo SG for P=20mV, L+R=180mV, f=1kHz, L:on (R:off). Then adjust the pin-8 external semi-fixed resistance VR<sub>102</sub> (220ΩB) to minimize the R-side output leak.
- (2) Set the stereo SG for R:on (L:off), and adjust VR<sub>102</sub> to minimize the L-side output leak.
- (3) Repeat the above adjustments, and make the L-side and R-side leaks equal and minimum.

■ HA11227/HA12018 CHARACTERISTICS

The following consideration is taken for the design of HA11227 and HA12018.

[1] Supply Voltage Range

(1) Internal Stabilized Power Source

Internal stabilized power source is set at 3V, and its tolerance does not exceed 100mV if Vcc fluctuates from 4V to 16V. Therefore, there are almost no deterioration of performance within the Vcc range of 4 to 16V (One point adjustment at Vcc=9V). Moreover, no zener diode is employed to avoid unexpected zener noise. As a result, signal-to-noise ratio is not damaged.

(2) Anti-Shock-Noise Protection

Generally, PLL multiplex decoder generates shock noise when VCO free running frequency fluctuates and PLL leak is released. However, HA11227 and HA12018 do not generate any shock noise because the decoder is automatically switched to monaural before PLL lock is released by detecting the voltage fluctuation. (When Vcc goes down to 3.5V typ., the stereo output is compulsorily switched to monaural)

[2] Ripple Rejection

When ripple is supposed on supply voltage, unexpected motor-boarding is caused if ripple rejection is not enough. To realize higher rejection ratio, load on the decoder is earthed and consideration is taken for the other circuit. As a result, 40dB(typ) ripple rejection ratio is obtained.

[3] Maximum Supply Voltage

Max. rated voltage is set at 16V. When V.C.O free running frequency and separation are adjusted at Vcc=9V, the same characteristics as Vcc=9V is realized.

[4] Operating Supply Current (Without Lamp Current)

Operating supply current of HA11227 and HA12018 is 10mA typ., and this value is much lower than that of conventional PLL MPX IC. The alteration ratio of supply current is 0.5mA typ. within the Vcc range of 14 to 16V.

[5] Voltage Gain

Voltage gain in the recommended circuit is set at -2dB typ. to prevent Vcc from dropping to below 3V. If the minimum value of Vcc is more than 3V, larger voltage gain is obtained.

■ EXTERNAL PARTS

Part No.	Recommended Value	Purpose	Influence		Note
			Smaller than Recommended Value	Larger than Recommended Value	
R101	4.7kΩ	Input Equivalent Resistance	—	—	—
C101	100μF	Decoupling	—	—	—
C102	2.2μF	Input DC Cut	Deterioration of Frequency Characteristics	Production of Larger Pop Noise	—
C103	0.047μF	PLL Input DC Cut	Deterioration of Separation	—	—
C104	1μF	L.P.F. in PLL	Deterioration of Stereo Harmonic Distortion	Narrower Capture Range	Special synthesis of 3 parts
C105	0.33μF				
R102	1kΩ				
R103	22kΩ	V.C.O Free-Running Frequency Adjustment	Incapable of adjusting the V.C.O free-running frequency in connection with C106		—
VR101	10kΩ (B)				Carbon covered
C106	470pF		Larger V.C.O jitter	Narrower Capture Range	Styrol Capacitor (±10%)
R104	3.3kΩ	Load Resistance	Lower Output Voltage	Narrower Supply Voltage Range	—
R105	3.3kΩ				
C107	0.015μF	Determination of de-emphasis	—	—	—
C108	0.015μF				
R106	100kΩ	Forced Monaural Terminal Current Limitation	—	—	—
C109	1μF	Time Constant for Forced Monaural	—	—	—
R107	120Ω	Lamp Current Limiting Resistance	IC Destruction by Rush Current	Insufficient Lamp Illuminance	1/2W
R108	15kΩ	Counter-measures against damage of ST Indicator Lamp	Insufficient Lamp Illuminance	Stereo operation will discontinue at the time of Lamp destruction	(Note 1)
R109	100kΩ	Buffer under V.C.O Frequency Monitoring	Malfunction by Monitor	Insufficient input to Frequency Counter	—
C110	2.2μF	L.P.F in Lamp Circuit	Lamp malfunction will easily occur	Lamp Illuminance will be delayed	—

Note: Determine R108 in accordance with lamp supply voltage. Set R108 so as to keep the current flow of more than 0.5mA even if the lamp is damaged and supply voltage is reduced.

T.H.D., R-SIDE OUTPUT VOLTAGE AND CHANNEL BALANCE VS. SUPPLY VOLTAGE

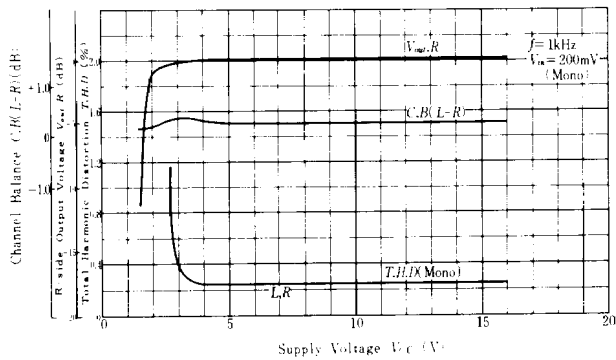

SIGNAL-TO-NOISE RATIO VS. SUPPLY VOLTAGE

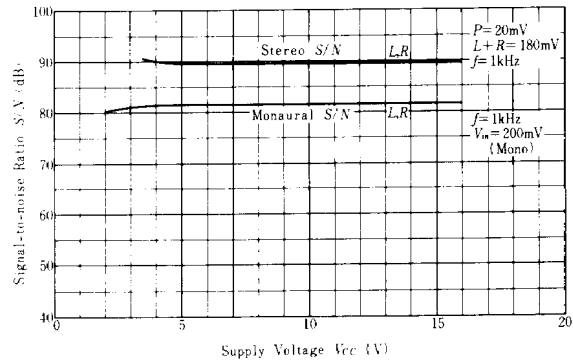

HUM REJECTION RATIO VS. FREQUENCY

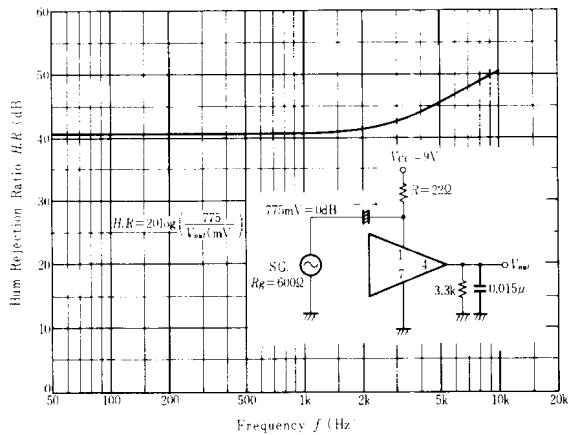

CAPTURE RANGE AND LOCK RANGE VS. FREE RUNNING FREQUENCY

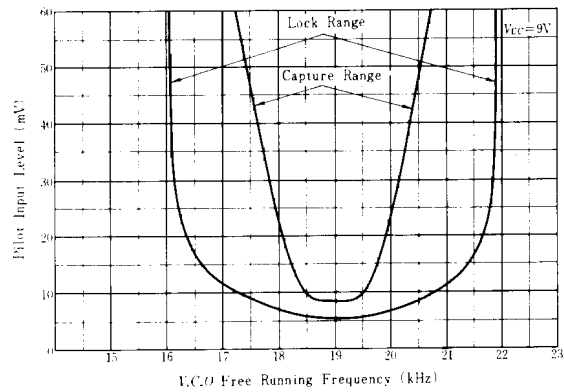

CAPTURE RANGE AND LOCK RANGE VS. SUPPLY VOLTAGE

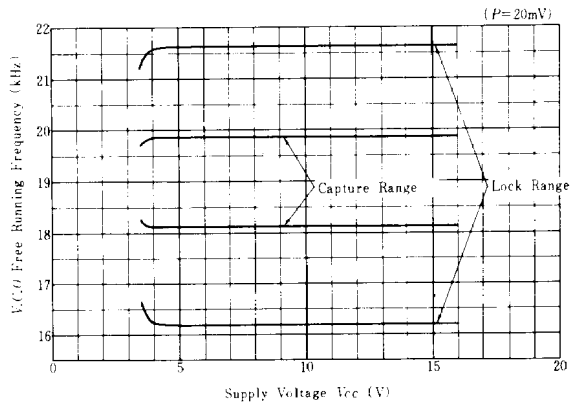

V.C.O FREE RUNNING FREQUENCY AND PILOT LAMP INPUT LEVEL VS. SUPPLY VOLTAGE

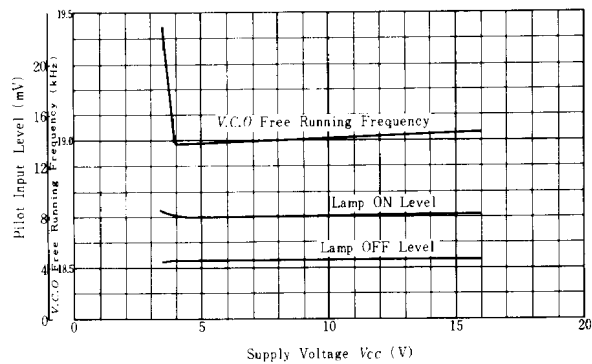

SEPARATION AND TOTAL HARMONIC DISTORTION VS. FREQUENCY

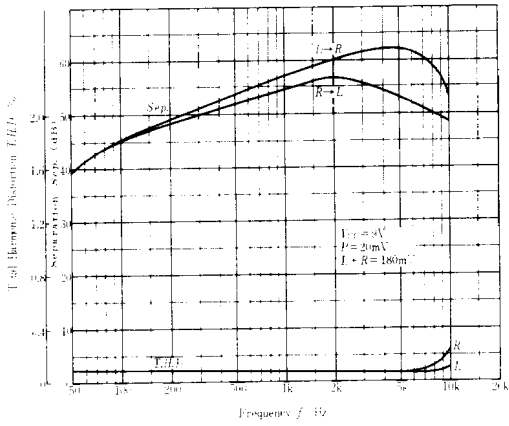

TOTAL HARMONIC DISTORTION AND SEPARATION VS. INPUT VOLTAGE

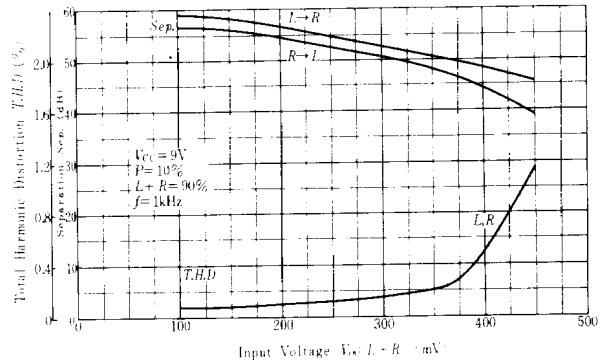

TOTAL HARMONIC DISTORTION AND SEPARATION VS. SUPPLY VOLTAGE

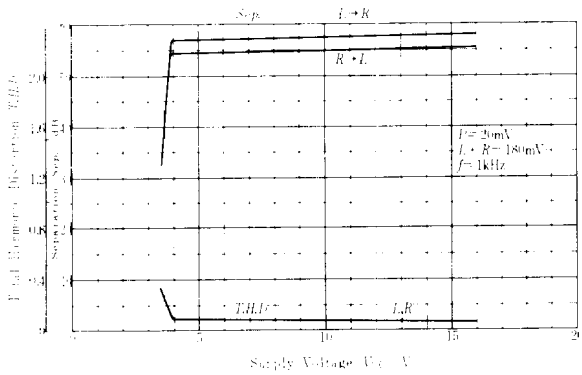

TOTAL HARMONIC DISTORTION AND SEPARATION VS. V.C.O FREE RUNNING FREQUENCY

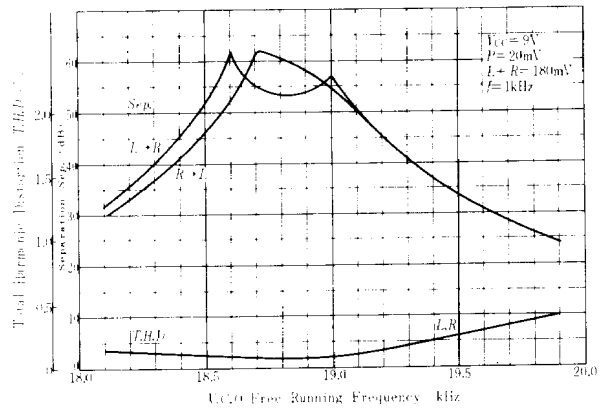

TOTAL HARMONIC DISTORTION, R-SIDE OUTPUT VOLTAGE AND CHANNEL BALANCE VS. FREQUENCY

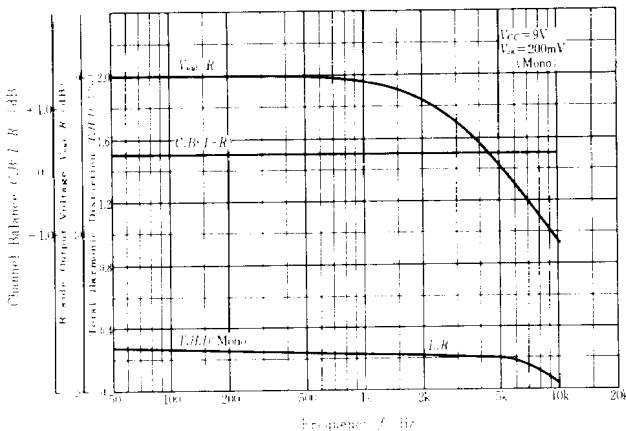

T.H.D., R-SIDE OUTPUT VOLTAGE AND CHANNEL BALANCE VS. INPUT VOLTAGE

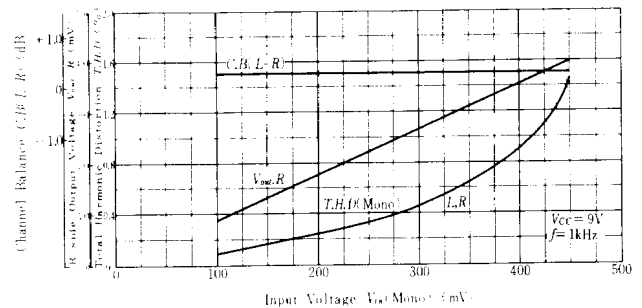

**V.C.O FREE RUNNING FREQUENCY VS.  
AMBIENT TEMPERATURE**