

HA12017

Low Noise Preamplifier

FEATURES

- Low Noise: $V_n(\text{in})=0.185\mu\text{V}$ typ. (IHF-A Network, $R_g=43\Omega$, RIAA)
- Wide dynamic range: $V_{\text{in}}=235\text{mVrms}$ typ. ($V_{\text{cc}}=\pm 24.0\text{V}$, $f=1\text{kHz}$, THD=0.1%, $G_v=35.9\text{dB}$)
- Low distortion: THD=0.002% typ. ($f=20\text{Hz}$ to 20kHz , $V_{\text{out}}=10\text{Vrms}$, RIAA)
- Excellent supply ripple rejection:
 - SVR(+ V_{cc})=56dB typ. ($f=100\text{Hz}$, $R_g=43\Omega$)
 - SVR(- V_{cc})=45dB typ. ($f=100\text{Hz}$, $R_g=43\Omega$)



(SP-7)

BLOCK DIAGRAM & TYPICAL APPLICATION CIRCUIT

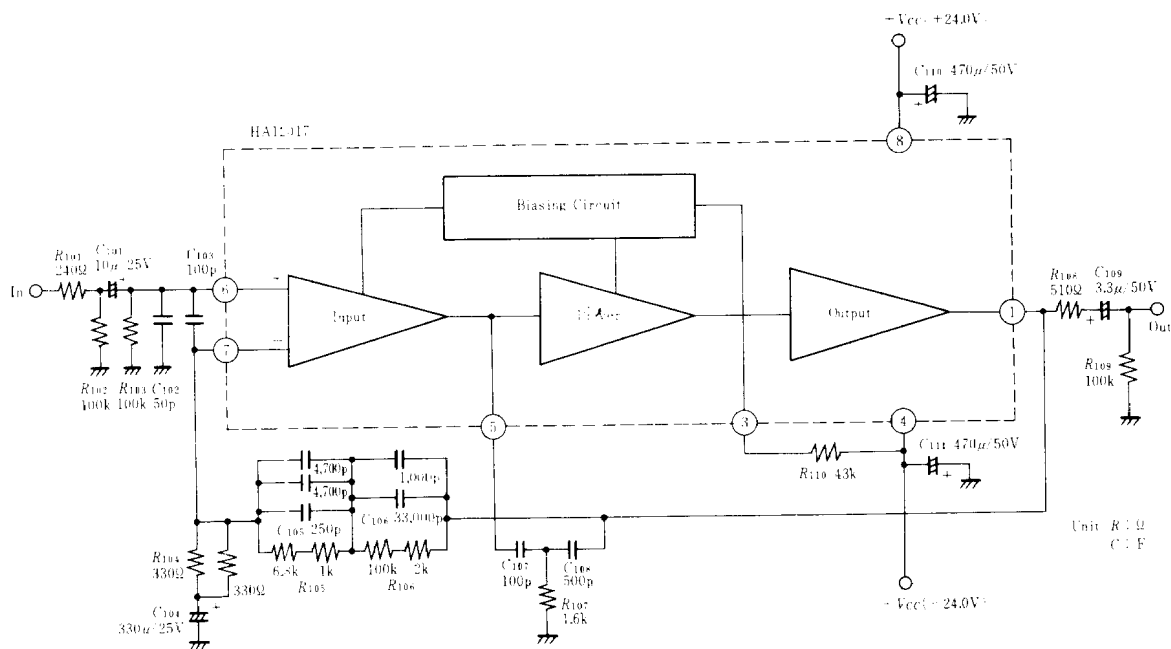

ABSOLUTE MAXIMUM RATINGS

Item	Symbol	Rating	Unit
Supply Voltage	V_{cc}	± 26.5	V
Power Dissipation	P_T^*	500	mW
Operating Temperature Range	T_{opr}	-30 to +75	$^{\circ}\text{C}$
Storage Temperature Range	T_{stg}	-55 to +125	$^{\circ}\text{C}$

* Value at $T_a = 75^{\circ}\text{C}$

■ ELECTRICAL CHARACTERISTICS ($V_{CC} = \pm 24V$, $T_a = 25^\circ C$)

Item*	Symbol	Test Conditions	min.	typ.	max.	Item
Quiescent Current	I_q	no input signal	—	4.0	6.0	mA
Open Loop Voltage Gain	$G_{V(OL)}$	$f = 1kHz$	95	105	—	dB
Total Harmonic Distortion	THD	$f = 1kHz$, $V_{out} = 10V$	—	0.002	0.01	%
Output Voltage	V_{out}	$f = 1kHz$, THD = 0.1%	13.5	14.7	—	V
Output Noise Voltage 1**	V_{n1}	$R_g = 43\Omega$, IHF-A Network	—	1.15	1.56	mV
Output Noise Voltage 2**	V_{n2}	$R_g = 3.3k\Omega$, BW = 20Hz to 20kHz	—	5.3	9.0	mV

Notes : * All the items except $G_{V(OL)}$ is tested with RIAA curve and $G_V = 35.9dB$.

**These items are measured after the flat amplifier ($G_V = 40dB$).

■ TEST CIRCUIT

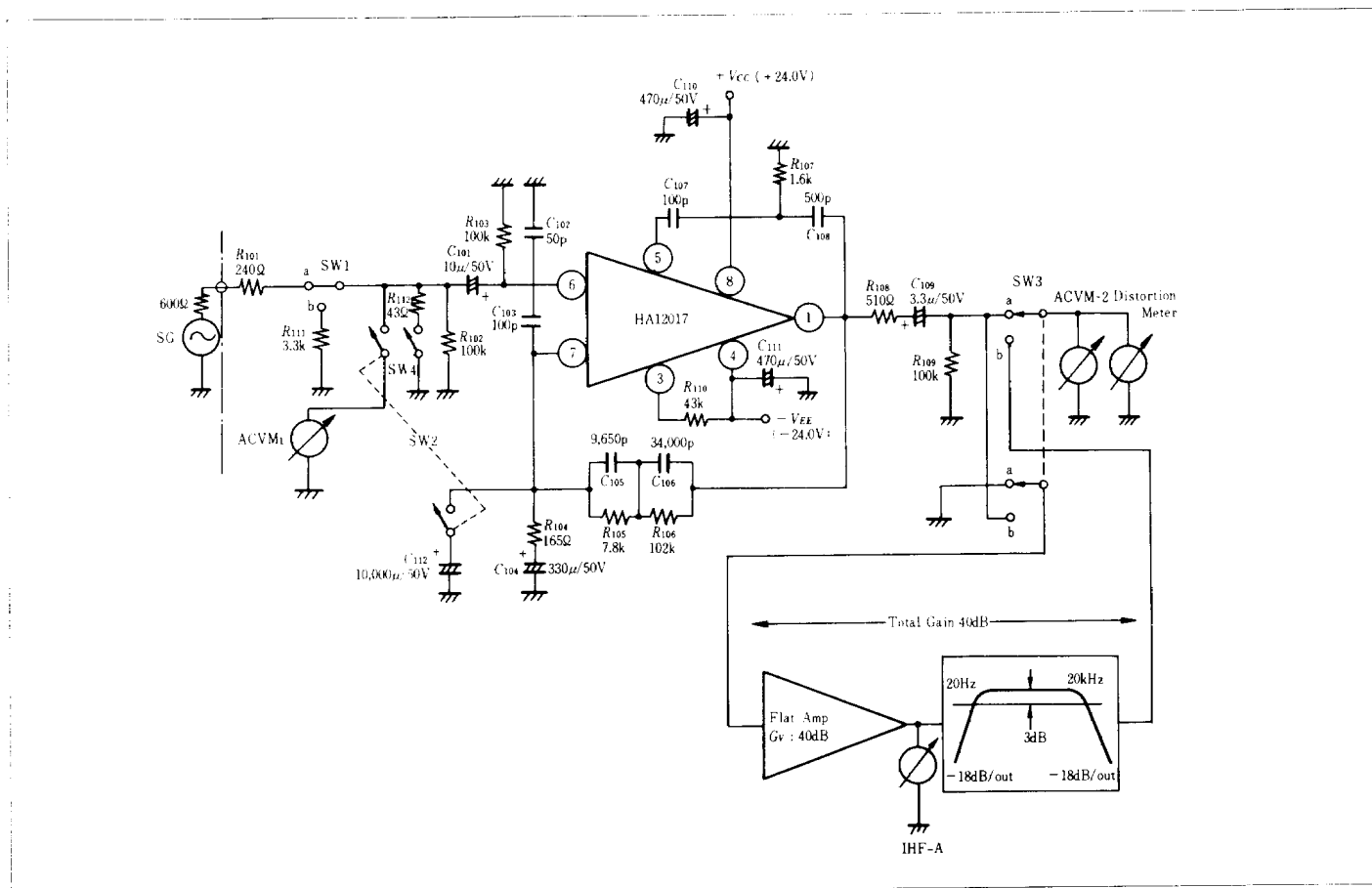

● NOTES "ON" TESTING

1. Measuring Apparatus

- SG: Matsushita VP7220B
- Distortion Meter: NF DM155
- IHF-A ACVM 3: B & K 2112
- ACVM 1 & 2: HP 400EL

2. Tolerance of External Parts

- Resistors: $\pm 1\%$
- Mira Capacitor (C_{105} , C_{106}): $\pm 2\%$
- Chemical Capacitor: $\pm 10\%$
- Ceramic Capacitor (C_{102} , C_{105} , C_{107} , C_{108}): $\pm 5\%$
- Temp. Coefficient $-80ppm/^\circ C$

3. Positions of Switches

Item	SW 1	SW 2	SW 3	SW 4
$G_{V(OL)}$	a	ON	a	OFF
V_{out}	a	OFF	a	OFF
THD	a	OFF	a	OFF
V_{n1}	b	OFF	b	ON
V_{n2}	b	OFF	b	OFF

■ PC-BOARD LAYOUT PATTERN

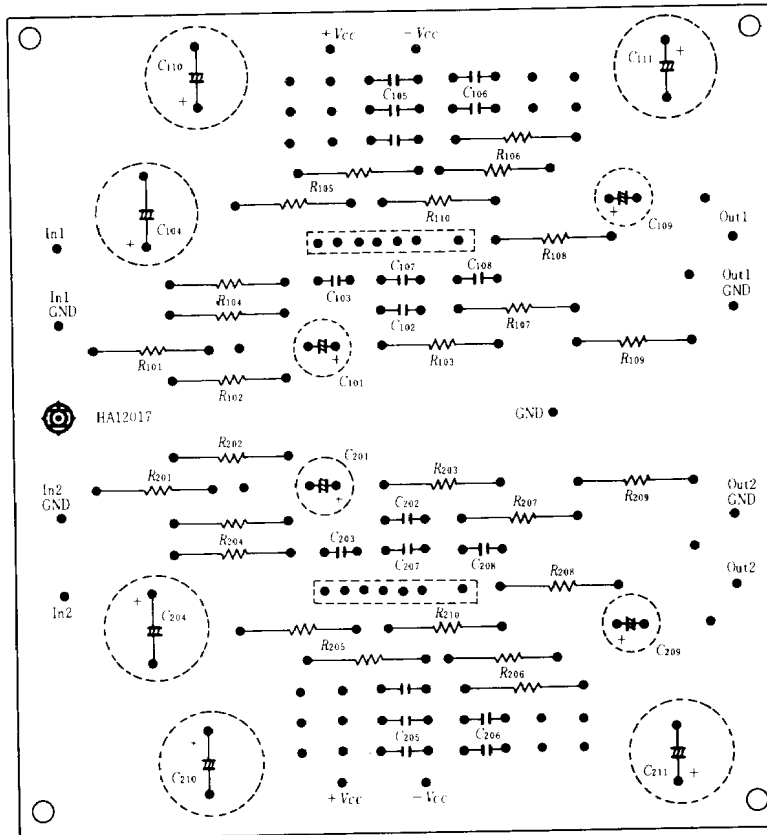

(Top View)

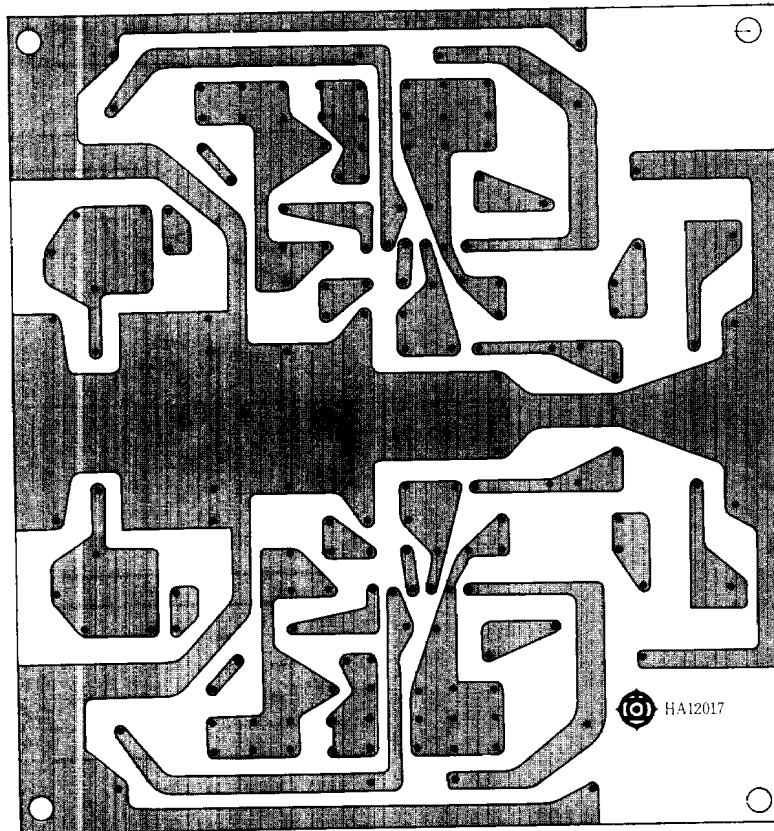

(Bottom View)

EXTERNAL COMPONENTS

1. Resistor

Part No.	Recommended Value	Functions	Deteriorations by using a value less than recommended	Deteriorations by using a value more than recommended	Cautions
R ₁₀₁	240Ω	<ul style="list-style-type: none"> Protects the IC from abnormal input voltage. Prevents parasitic oscillation caused by signal-source impedance. Decreases high-frequency disturbance. 	<ul style="list-style-type: none"> High-frequency often disturbed. Using less than 43Ω deteriorates stability to a high degree. 	<ul style="list-style-type: none"> Thermal noise generates, resulting in signal-to-noise ratio deterioration. 	
R ₁₀₂	100kΩ	<ul style="list-style-type: none"> Passes the electric charge of C₁₀₁. Decides R_{in} (input resistance) $R_{in} = R_{101} + (R_{102}/R_{103})$ 	<ul style="list-style-type: none"> Input resistance decreases. 	<ul style="list-style-type: none"> Electric-charge passing lowered. 	
R ₁₀₃	100kΩ	<ul style="list-style-type: none"> Supplies DC bias to pin-6 (input pin) Decides input resistance. 	<ul style="list-style-type: none"> Input resistance decreases. 	<ul style="list-style-type: none"> Output offset voltage increases. 	<ul style="list-style-type: none"> $R_{103} \approx R_{105} + R_{106}$
R ₁₀₄	165Ω	<ul style="list-style-type: none"> Decides voltage gain as feedback resistance. 	<ul style="list-style-type: none"> Load of pin-1 (output pin) increases in high-frequency range, reducing output voltage. 	<ul style="list-style-type: none"> Thermal noise generates, resulting in signal-to-noise ratio deterioration. 	
R ₁₀₅ R ₁₀₆	7.8kΩ 102kΩ	<ul style="list-style-type: none"> Decides RIAA characteristics, in pairs with C₁₀₅ and C₁₀₆. 	<ul style="list-style-type: none"> Unbalance with R₁₀₃ increases output offset voltage. 	<ul style="list-style-type: none"> Unbalance with C₁₀₃ increases output offset voltage. 	<ul style="list-style-type: none"> The errors of R₁₀₅ and R₁₀₆ must be small enough.
R ₁₀₇	1.6kΩ	<ul style="list-style-type: none"> In a pair with C₁₀₈, decides the frequency at which G_{V(OL)} characteristic changes from -12dB/oct to -6dB/oct. 	<ul style="list-style-type: none"> Incomplete phase-compensation deteriorates stability. 	<ul style="list-style-type: none"> Total harmonic distortion increases. 	
R ₁₀₈	510Ω	<ul style="list-style-type: none"> Prevents parasitic oscillation caused by capacitive load. 	<ul style="list-style-type: none"> Prevention of parasitic oscillation lowered. 		
R ₁₀₉	100kΩ	<ul style="list-style-type: none"> Keeps the voltage of output terminals at DC standard level. Prevents shock noise caused by function-switching. 	<ul style="list-style-type: none"> Load increasing, max. output voltage decreases. 	<ul style="list-style-type: none"> Prevention of shock noise lowered. 	
R ₁₁₀	43kΩ	<ul style="list-style-type: none"> Decides basic bias current $R_{110} = (I + V_{CC} - (-V_{CC}) - 5) k\Omega$ 	<ul style="list-style-type: none"> Excessive P_T causes breakdown G_{V(OL)} increasing, stability deteriorates. Noise caused by current increases. 	<ul style="list-style-type: none"> G_{V(OL)} decreasing, total harmonic distortion increases. Noise increases. 	<ul style="list-style-type: none"> Capacitance must not connect between R₁₁₀ and pin-4 /GND.

2. Capacitor

Part No.	Recommended Value	Functions	Deteriorations by using a value less than recommended	Deteriorations by using a value more than recommended	Cautions
C ₁₀₁	10μF	<ul style="list-style-type: none"> Makes input-coupling. 	<ul style="list-style-type: none"> Impedance of signal source increasing, 1/f noise increases. 		<ul style="list-style-type: none"> The leakage-current of C₁₀₁ must be small enough.
C ₁₀₂	50pF	<ul style="list-style-type: none"> In combination with C₁₀₃, increases stability of large-amplitude operation in high frequency range. 	<ul style="list-style-type: none"> Prevention of parasitic oscillation lowered. 	<ul style="list-style-type: none"> Input impedance decreases at high frequency range. Prevention of parasitic oscillation lowered. 	<ul style="list-style-type: none"> High-frequency characteristic of C₁₀₂ must be sufficient.
C ₁₀₃	100pF	<ul style="list-style-type: none"> In strong field, prevents detection of TV, FM and AM signals. 	<ul style="list-style-type: none"> High-frequency often disturbed in a strong field. Prevention of parasitic oscillation lowered. 	<ul style="list-style-type: none"> Prevention of parasitic oscillation lowered. 	<ul style="list-style-type: none"> High-frequency characteristic of C₁₀₃ must be sufficient.
C ₁₀₄	330μF	<ul style="list-style-type: none"> Supplies full DC-feedback. Decides roll-off frequency (f_L) in low frequency range. $f_L = 3\text{Hz}$ (Typical application) $f_L = \frac{1}{2\pi C_{104} \cdot R_{104}}$ 	<ul style="list-style-type: none"> Roll-off frequency in low-frequency range goes higher. 	<ul style="list-style-type: none"> More time is required to stabilize the potential of pin-1. 	
C ₁₀₅ C ₁₀₆	9650pF 34000pF	<ul style="list-style-type: none"> Decides RIAA characteristics in pairs with R₁₀₅ and R₁₀₆. 	<ul style="list-style-type: none"> RIAA characteristics deteriorates. 	<ul style="list-style-type: none"> RIAA characteristics deteriorates. 	<ul style="list-style-type: none"> The errors of C₁₀₅ and C₁₀₆ must be small enough.
C ₁₀₇	100pF	<ul style="list-style-type: none"> Supplies phase-compensation. 	<ul style="list-style-type: none"> Incomplete phase-compensation deteriorates stability. 	<ul style="list-style-type: none"> Total harmonic distortion increases. 	<ul style="list-style-type: none"> For C₁₀₇, temperature and high-frequency characteristics must be sufficient, and the error must be small enough.
C ₁₀₈	500pF	<ul style="list-style-type: none"> In a pair with R₁₀₇, decides the frequency at which G_{V(OL)} characteristic changes from -12dB/oct to -6dB/oct. 	<ul style="list-style-type: none"> Incomplete phase-compensation deteriorates stability. 	<ul style="list-style-type: none"> Total harmonic distortion increases. 	<ul style="list-style-type: none"> For C₁₀₈, temperature and high-frequency characteristics must be sufficient, and the error must be small enough.
C ₁₀₉	3.3μF	<ul style="list-style-type: none"> Makes output-coupling. 	<ul style="list-style-type: none"> Too low capacitance increases output-impedance and reduces output voltage in low frequency range. 		
C ₁₁₀ C ₁₁₁	470μF 470μF	<ul style="list-style-type: none"> Removes ripple on V_{CC} line. 	<ul style="list-style-type: none"> Increases cross-talk between left and right channels. 		

INPUT NOISE VOLTAGE vs. SOURCE IMPEDANCE

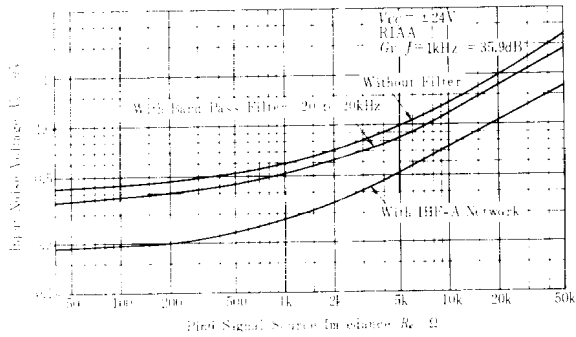

TOTAL HARMONIC DISTORTION vs. OUTPUT VOLTAGE

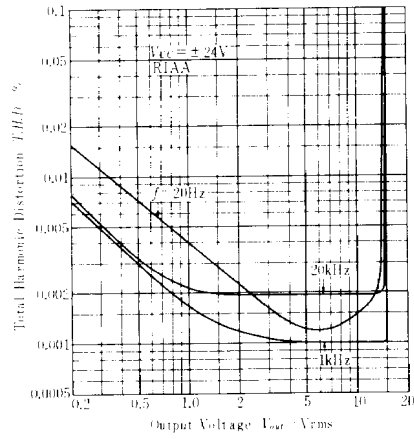

OUTPUT VOLTAGE vs. INPUT VOLTAGE

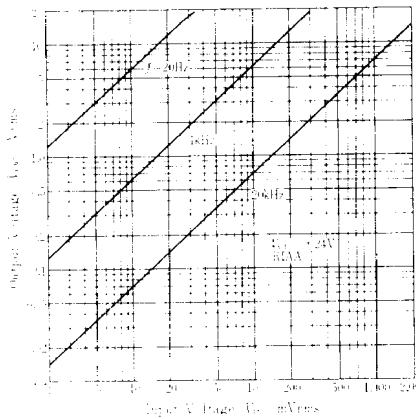

OPEN-LOOP VOLTAGE GAIN vs. FREQUENCY

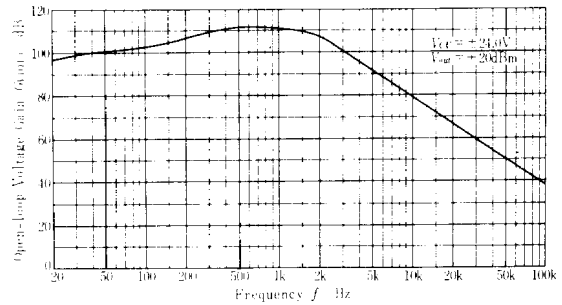

CLOSED-LOOP VOLTAGE GAIN vs. FREQUENCY

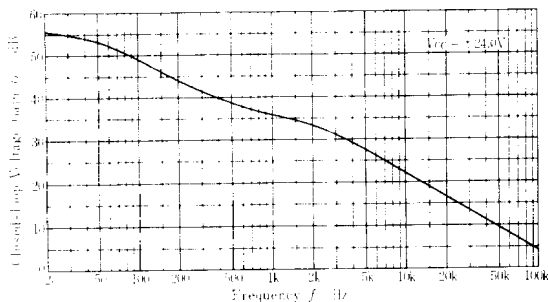

OUTPUT VOLTAGE AND TOTAL HARMONIC DISTORTION vs. FREQUENCY

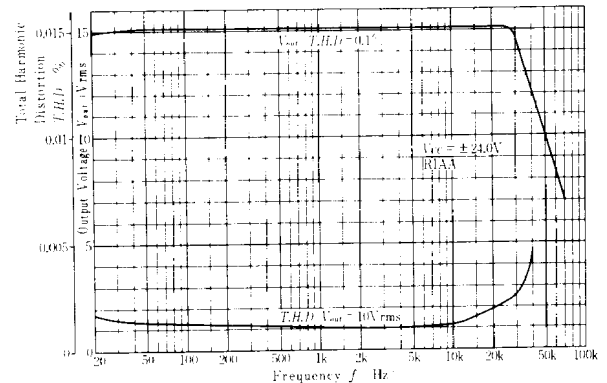

RIPPLE REJECTION VS. FREQUENCY

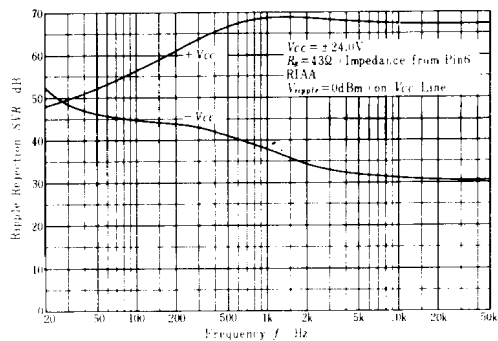

RIPPLE REJECTION VS. SOURCE IMPEDANCE

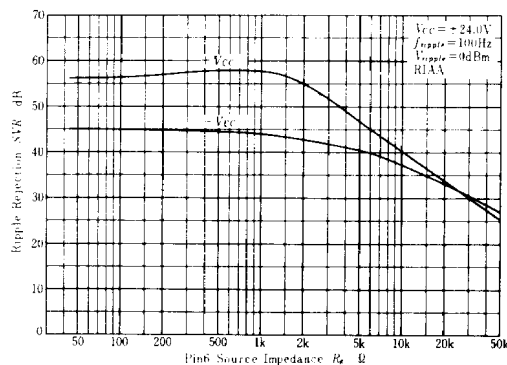

QUIESCENT CURRENT VS. SUPPLY VOLTAGE

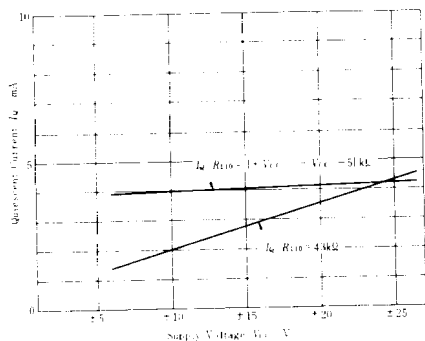

OUTPUT VOLTAGE VS. SUPPLY VOLTAGE

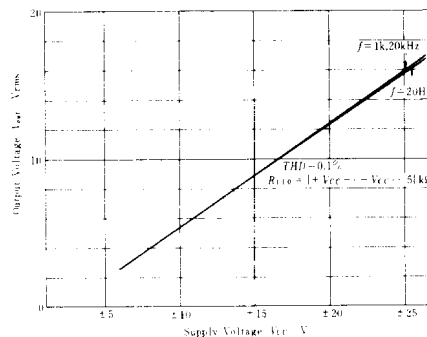

INPUT NOISE VOLTAGE VS. SUPPLY VOLTAGE

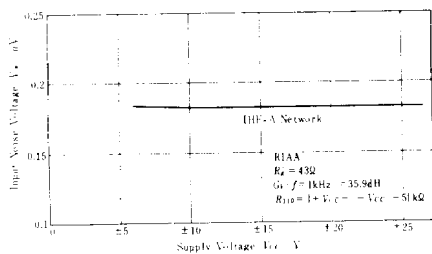

OUTPUT VOLTAGE AND TOTAL HARMONIC DISTORTION VS. AMBIENT TEMPERATURE

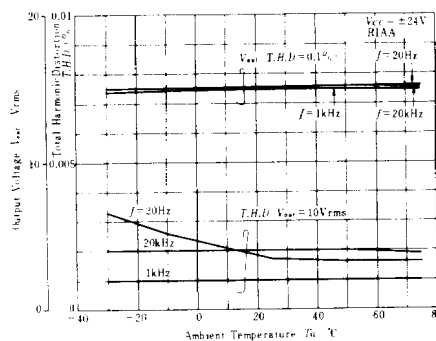

QUIESCENT CURRENT VS. AMBIENT TEMPERATURE

