

Dual Power Supply Controller

The ISL6118 is a dual channel, fully independent overcurrent (OC) fault protection IC for the +2.5V to +5.5V environment. This device features internal current monitoring, accurate current limiting, integrated power switches and current limited delay to latch-off for system protection.

The ISL6118 current sense and limiting circuitry sets the current limit to a nominal 0.6A, which is well suited for the 3.3V AUX ACPI application. The ISL6118 is the ideal companion chip to the HIP1011D and HIP1011E dual PCI hot plug controllers. Together these and the ISL6118 fully control the four legacy PCI voltages (+/-12V, +3.3V, +5V) and the 3.3V AUX, respectively for power control of two PCI slots compliant to PCI Bus Power Management Interface Spec Rev 1.1. Designed to be co-located with the HIP1011D on the motherboard, the ISL6118 provides OC fault notification, accurate current limiting and a consistent timed latch-off thus isolating and protecting the voltage bus in the presence of an OC event or short circuit during all PCI Bus Power States as defined by the PCI specification. The 12ms time to latch-off is independent of the adjoining switch's electrical or thermal condition and the OC response time is inversely related to the OC magnitude.

Each ISL6118 incorporates in a single 8-lead SOIC package two 80mΩ N-channel MOSFET power switches for power control. Each switch is driven by a constant current source giving a controlled ramp up of the output voltage. This provides a soft start turn-on eliminating bus voltage drooping caused by inrush current while charging heavy load capacitances. Independent enabling inputs and fault reporting outputs for each channel are compatible with 3V and 5V logic to allow external control and monitoring.

The ISL6118 undervoltage (UV) feature prevents turn-on of the outputs unless the correct ENABLE state and $V_{IN} > 2.5V$ are present. During initial turn-on the ISL6118 prevents fault reporting by blanking the fault signal. Rising and falling outputs are current-limited voltage ramps so that both the inrush current and voltage slew rate are limited, independent of load. This reduces supply droop due to surge and eliminates the need for external EMI filters. During operation, once an OC condition is detected the appropriate output is current limited for 12ms to allow transient conditions to pass. If still in current limit after the current limit period has elapsed, the output is latched off and the fault is reported by pulling the corresponding FAULT low. The FAULT signal is latched low until reset by the ENABLE signal being de-asserted at which time the FAULT signal will clear.

Features

- 80mΩ Integrated Power N-Channel MOSFET Switches
- Accurate Current Sensing and Limiting
- 12ms Fault Delay to Latch-Off, No Thermal Dependency
- 2.5V to 5.5V Operating Range
- Disabled Output Internally Pulled Low
- Undervoltage Lockout
- Controlled Turn-On Ramp Time
- Channel Independent Fault Output Signals
- Compatible with 3.3V and 5V Logic Families
- Channel Independent Logic Level Enable High Inputs (ISL6118H) or Enable Low Inputs (ISL6118L)

Applications

- ACPI 3.3V AUX Control
- Electronic Circuit Limiting and Breaker

Ordering Information

PART NUMBER	TEMP. RANGE (°C)	PACKAGE	PKG. NO.
ISL6118LIB	-40 to 85	8 Ld SOIC	M8.15
ISL6118LIB-T	-40 to 85	8 Ld SOIC Tape and Reel	
ISL6118HIB	-40 to 85	8 Ld SOIC	M8.15
ISL6118HIB-T	-40 to 85	8 Ld SOIC Tape and Reel	
ISL6118EVAL1	ISL6118 Evaluation Platform		
ISL16AHPEVAL1	ACPI (HIP1011D and ISL6118H) Evaluation Platform		

Pinout

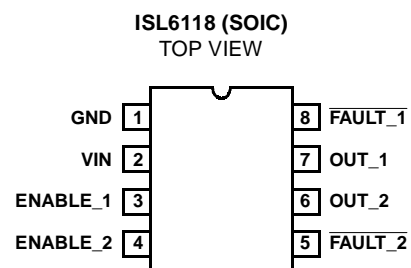

Simplified Block Diagram

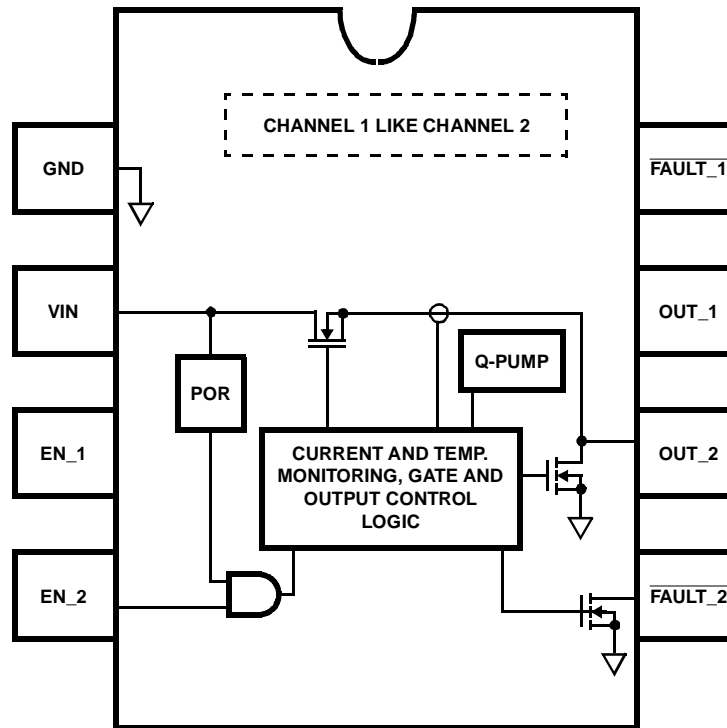

Pin Descriptions

PIN NO.	DESIGNATOR	FUNCTION	DESCRIPTION
1	GND	IC Reference	
2	VIN	Chip Bias, Controlled Supply Input, Undervoltage Lock-Out	VIN provides chip bias voltage. At VIN < 2.5V chip functionality is disabled, FAULT_X latch is cleared and floating and OUT is held low.
3, 4	ENABLE_1, 2 / ENABLE_1,2	Channel Enable / Enable not Inputs	Enables/Disables switch.
5, 8	FAULT OUT_2, 1	Channel 2, 1 Over Current Fault not Indicator	Channel overcurrent fault-not indicator. FAULT floats and is disabled until VIN > 2.5V. This output is pulled low after the OC timeout period has expired and stays latched until ENABLE is deasserted.
6, 7	OUT_2, 1	Channel 2,1 Controlled Supply Output	Channel voltage output, connect to load to protect. Upon an OC condition OUT is current limited to 0.6A. Current limit response time is within 200uS. This output will remain in current limit for a determined time before being latched off.

Absolute Maximum Ratings

Supply Voltage (VIN to GND)	6.0V
EN, FAULT	-0.3V to 6V
OUT	GND-0.3V to VIN +0.3V
Output Current	Short Circuit Protected
ESD Rating	
Human Body Model (Per MIL-STD-883 Method 3015.7)	3KV

Thermal Information

Thermal Resistance (Typical, Note 1)	θ_{JA} (°C/W)
8 Lead SOIC Package	116
Maximum Junction Temperature	150°C
Maximum Storage Temperature Range	-65°C to 150°C
Maximum Lead Temperature (Soldering 10s)	300°C
(SOIC - Lead Tips Only)	

Operating Conditions

Temperature Range	-40°C to 85°C
Supply Voltage Range (Typical)	2.7V to 5.5V

CAUTION: Stresses above those listed in "Absolute Maximum Ratings" may cause permanent damage to the device. This is a stress only rating and operation of the device at these or any other conditions above those indicated in the operational sections of this specification is not implied.

NOTES:

- θ_{JA} is measured with the component mounted on a high effective thermal conductivity test board in free air. See Tech Brief TB379 for details.
- All voltages are relative to GND, unless otherwise specified.

Electrical Specifications Supply Voltages = 3.3V, $T_A = T_J = -40$ to 85°C, Unless Otherwise Specified

PARAMETER	SYMBOL	TEST CONDITIONS	MIN	TYP	MAX	UNITS
POWER SWITCH						
ISL6118 On Resistance at 2.7V	$r_{DS(ON)_27}$	VIN = 2.7V, I _{OUT} = 0.4A, T _A = T _J = 25°C	-	90	105	mΩ
		T _A = T _J = 85°C	-	115	130	mΩ
ISL6118 On Resistance at 3.3V	$r_{DS(ON)_33}$	VIN = 3.3V, I _{OUT} = 0.4A, T _A = T _J = 25°C	-	80	100	mΩ
		T _A = T _J = 85°C	-	115	130	mΩ
ISL6118 On Resistance at 5.0V	$r_{DS(ON)_50}$	VIN = 5V, I _{OUT} = 0.4A, T _A = T _J = 25°C	-	80	95	mΩ
		T _A = T _J = 85°C	-	115	130	mΩ
Disabled Output Voltage	V _{OUT_DIS}	VIN = 5V, Switch Disabled, 50μA Load	-	300	450	mV
OUT Rising Rate	t _{vout_rt}	R _L = 10Ω, C _L = 0.1μF, 10%-90%	-	8	-	V/ms
Slow V _{OUT} Turn-off Rate	t _{svout_offt}	R _L = 10Ω, C _L = 0.1μF, 90%-10%	-	8	-	V/ms
Fast V _{OUT} Turn-off Rate	t _{fvout_offt}	R _L = 1Ω, C _L = 0.1μF, 90%-10%	-	4	-	V/μS
CURRENT CONTROL						
Current Limit, VIN = 3.3V - 5V	I _{lim}	V _{OUT} = 0.8V	0.45	0.6	0.75	A
OC Regulation Settling Time	t _{settIlim}	R _L = 3Ω, C _L = 0.1μF to within 10% of CR	-	2	-	ms
Severe OC Regulation Settling Time	t _{settIlim_sev}	R _L < 1Ω, C _L = 0.1μF to within 10% of CR	-	100	-	μs
Over Current Latch-off Time	t _{OC_loff}	ISL6118X, T _J = 25°C	-	12	-	ms
I/O PARAMETERS						
Fault Output Voltage	V _{FAULT}	Fault Output Current = 10mA	-	-	0.4	V
ENABLE High Threshold	V _{en_vih}	VIN = 5.5V	2.0	-	-	V
ENABLE Low Threshold at 2.7V	V _{en_vil}	VIN = 2.7V	-	-	0.6	V
ENABLE Low Threshold at 5.5V	V _{en_vil}	VIN = 5.5V	-	-	0.8	V
ENABLE Input Current	I _{en_i}	ENABLE = 0V to 5V, VIN = 5V, T _J > 25°C	-0.5	0	0.5	μA
BIAS PARAMETERS						
Enabled VIN Current	I _{VDD}	Switches Closed, OUTPUT = OPEN, T _J > 0°C	-	120	200	μA
Disabled VIN Current	I _{VDD}	Switches Open, OUTPUT = OPEN	-	1	5	μA
Under voltage Lockout Threshold	V _{UVLH}	VIN Rising, Switch Enabled	1.7	2.25	2.5	V
UV Hysteresis	UV _{HYS}		50	100	-	mV
Over Temperature Disable	Temp _{dis}		-	150	-	°C

Introduction

The ISL6118 is a fully independent dual channel overcurrent (OC) fault protection IC for the +2.5V to +5.5V environment. Each ISL6118 incorporates in a single 8-lead SOIC package two 80mW N-channel MOSFET power switches for power control. See Figure 2 for integrated FET on resistance curves. Independent enabling inputs and fault reporting outputs compatible with 3V and 5V logic allow for external control and monitoring. This device features internal current monitoring, accurate current limiting, integrated power switches and current limited timed delay to latch-off for system protection.

Key Feature Description and Operation

UV Lockout

The ISL6118 undervoltage (UVLO) lockout prevents functionality of the device unless the correct ENABLE state and $V_{IN} > 2.5V$ are present.

Soft Start

A constant 500nA current source ramps up the switch's gate causing a voltage follower effect on the output voltage. This provides a soft start turn-on and eliminates bus voltage drooping caused by inrush current charging heavy load capacitances. Rising and falling outputs are current limited voltage ramps so that both the inrush current and voltage slew rate are limited, independent of load. This reduces supply droop due to surge and also eliminates the need for external EMI filters necessary on other IC products. See Figure 3 for soft start waveforms.

Fault Blanking on Start-Up

During initial turn-on the ISL6118 prevents nuisance faults from being reported to the system controller by blanking the fault signal for 12ms. This blanking eliminates the need for external RC filters necessary for other vendors' products.

Current Regulation

The ISL6118 has integrated current sensing on the power MOSFETs that allows for rapid control of OC events. Once an OC condition is detected the ISL6118 goes into its current regulation (CR) control mode. The ISL6118 CR level is set to a nominal 0.6A and is regulated to within +/-25% over full temperature, bias voltage range and OC magnitude. The speed of this control is proportional to the level of OC. Thus a hard OC is more quickly controlled than a marginal condition. See Figures 4 through 7 for current regulation performance curves and waveforms.

Latch-Off Time Delay

The primary function of any OC protection device is to quickly isolate the voltage bus from a faulty load. Unlike other manufacturers' IC products that sense the IC thermal condition to isolate a faulty load, the ISL6118 uses an internal 12ms timer that starts upon OC detection. Once an OC condition is detected, the appropriate output is current limited for 12ms to allow transient conditions to pass before latch-off. The time to latch-off is independent of the device's thermal or adjacent switch's electrical condition. See Figure 10 for waveforms illustrating independent latch-off.

If, after the ISL6118 has latched off, and the fault has asserted and the enable is not deasserted but the OC condition still exists, the ISL6118 unlike other IC devices does not send to the controller a continuous string of fault pulses. The ISL6118's single fault signal is sent at the time of latch off.

Slow and Fast Shutdown

The ISL6118 has two shutdown modes. When disabled with a load current less than the current regulation (CR) level the ISL6118 shuts down in a controlled manner using a 500nA constant current source controlled ramp. When disabled during CR or if the timer has expired the ISL6118 quickly pulls down the output thereby quickly removing the faulted load from the voltage bus. See Figures 8 and 9 for illustrative waveforms of each shutdown mode.

Over Temperature Shutdown

Although the ISL6118 has a thermal shutdown feature, because of the 12ms timed shutdown this will only be invoked in extremely high ambient temperatures.

Active Output Pulldown

Another unique ISL6118 feature is the active pull down on the outputs to 300mV above GND when the device is disabled.

Figure 1 illustrates the ISL6118 operational waveforms, showing the relationships between the various I/O signals during typical and faulted conditions. It also graphically highlights many of the terms and modes of operation referred to in this data sheet.

Using the ISL6118EVAL1 Platform

General and Biasing Information

The ISL6118EVAL1 platform, Figure 14, allows evaluation of the ISL6118 dual power supply control IC and comparison against a suitably sized PPTC component.

The evaluation platform is biased and monitored through numerous test points (TP#). See Table 1 for test point assignments and descriptions.

TABLE 1. ISL6118EVAL1 TEST POINT ASSIGNMENTS

TP #	DESCRIPTION
TP1	Eval Board and IC GND
TP2	Eval Board +3.3V Bias
TP3	Enable Switch 1
TP4	Enable Switch 2
TP5	Switch 2 Fault
TP6	Switch Out 2
TP7	Switch Out 1
TP8	Switch 1 Fault
TP9	IC VIN Pin
TP10	PPTC Load Side
TP11	Invoke Over Current

Typical Performance Curves

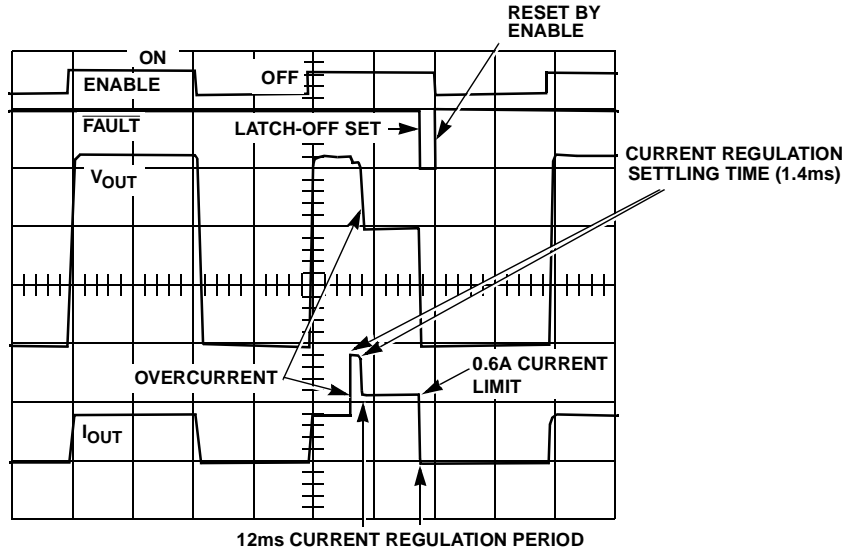

FIGURE 1. OPERATIONAL WAVEFORMS

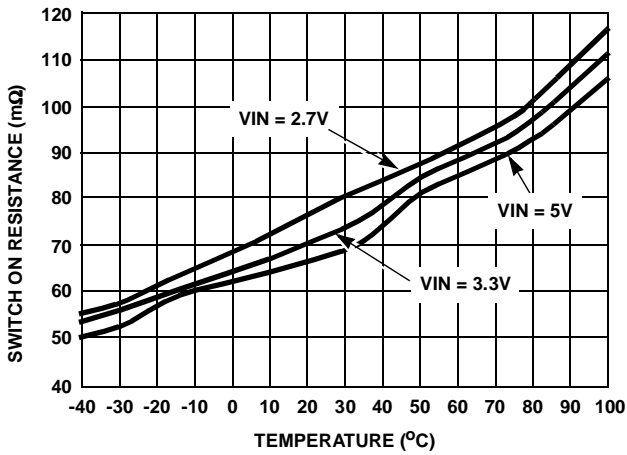

FIGURE 2. SWITCH ON RESISTANCE AT 0.4A

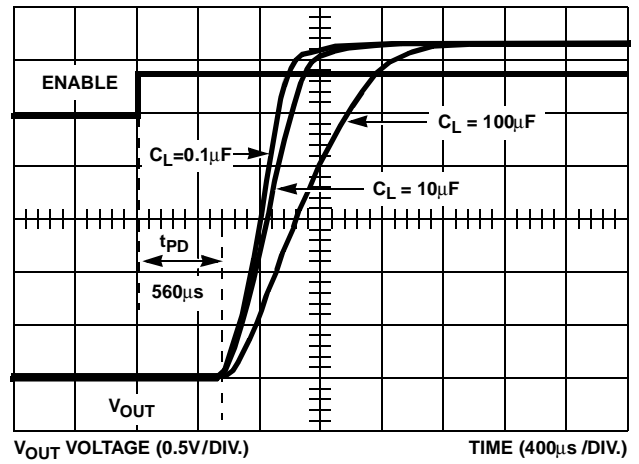

FIGURE 3. V_{OUT} SOFT START vs C_L and PROP DELAY, R_I = 8Ω

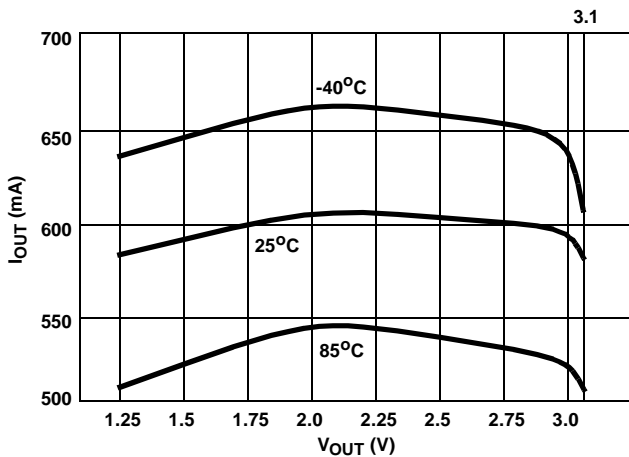

FIGURE 4. CURRENT REGULATION vs V_{OUT} (V_{IN} = 3.3V)

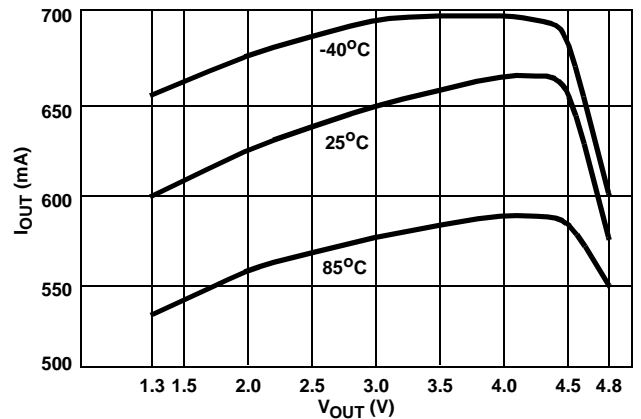

FIGURE 5. CURRENT REGULATION vs V_{OUT} (V_{IN} = 5V)

Typical Performance Curves (Continued)

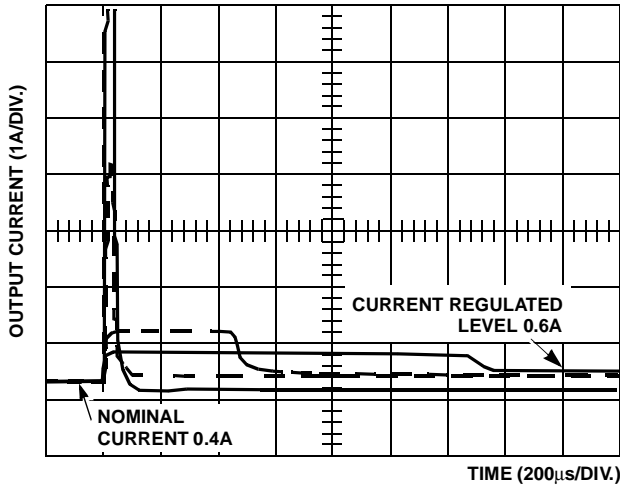

FIGURE 6. OC TO CR SETTLING TIME WAVEFORMS

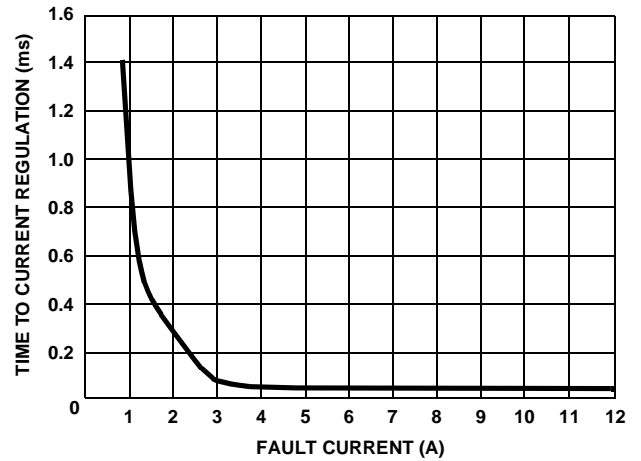

FIGURE 7. CR SETTLING TIME vs FAULT CURRENT

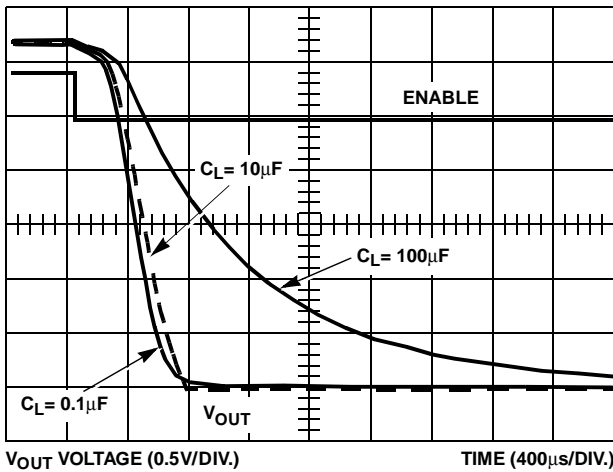

FIGURE 8. SLOW TURN-OFF vs C_L , $R_I=8\Omega$

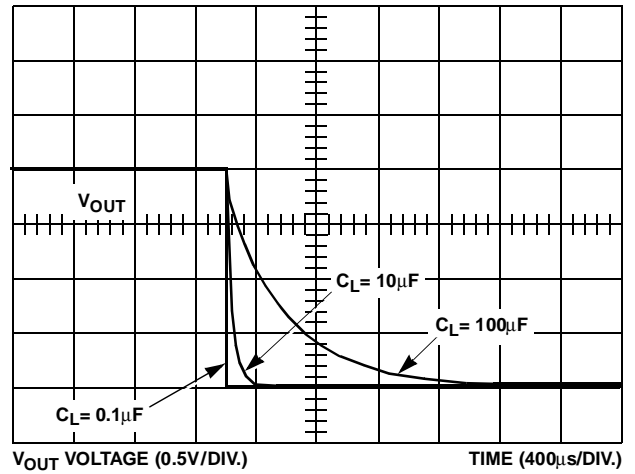

FIGURE 9. FAST TURN-OFF vs C_{LOADS}

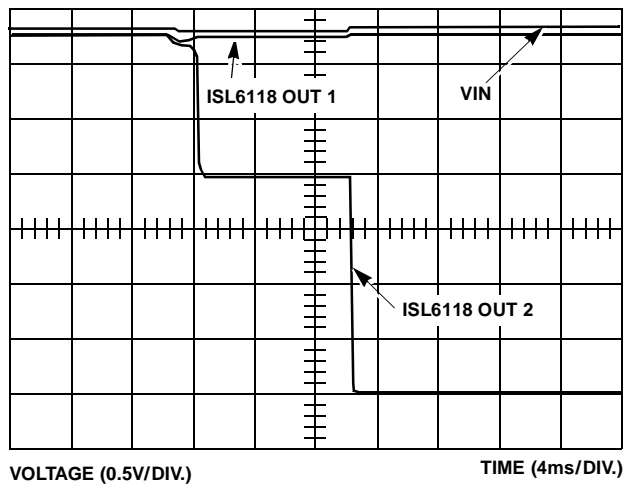
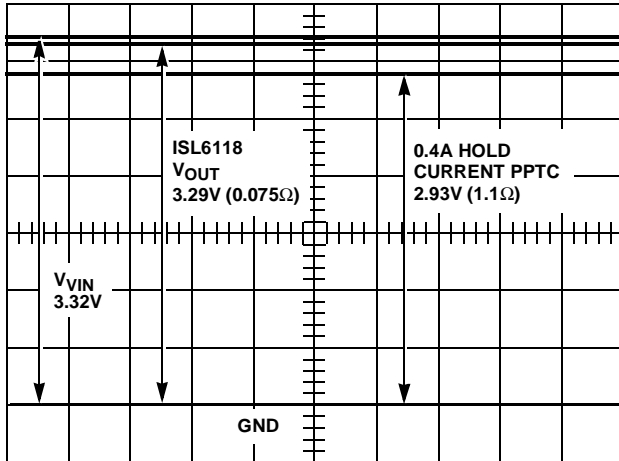

FIGURE 10. SWITCH FAULT INDEPENDENCE

Typical Performance Curves (Continued)



VOLTAGE (0.5V/DIV.)

FIGURE 11. ISL6118 vs PPTC INTO 8.2Ω LOAD

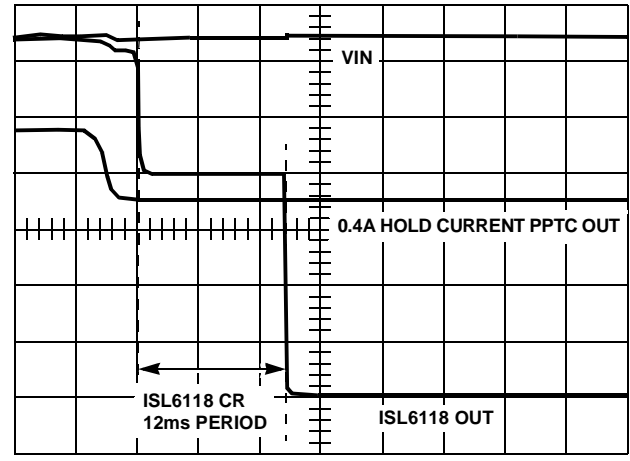

VOLTAGE (0.5V/DIV.)

TIME (4ms/DIV.)

FIGURE 12. ISL6118 vs PPTC INTO 3.5Ω LOAD

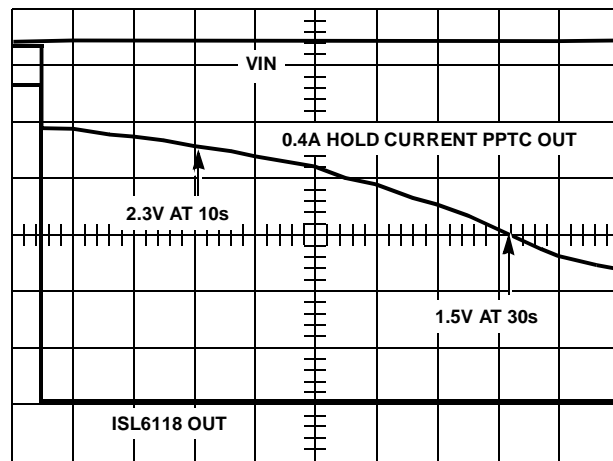

VOLTAGE (0.5V/DIV.)

TIME (4s/DIV.)

FIGURE 13. ISL6118 vs PPTC WITH EXTENDED 3.5Ω LOAD

Using the ISL6118EVAL1 Platform

Upon proper bias the PPTC, F1, has a nominal 400mA load current passing through it which is the hold current rating for that particular device. Removal of the PPTC is necessary to isolate the ISL6118 as the PPTC load current is common to the ISL6118EVAL1 bias connections.

By enabling either or both of the ISL6118H switches by signaling TP3 and/or TP4 high (> 2.4V) these switches are also loaded with a nominal 400mA current.

Provided test points enable the evaluation of voltage loss across the PPTC (TP9 - TP10) and likewise across the ISL6118 enabled switches (TP9 - TP6 and TP7). Expect to see 100% - 300% greater voltage loss across the PPTC than the ISL6118. See Figure 11 for ISL6118 vs PPTC voltage loss comparison.

An overcurrent (OC) condition can be invoked on both the ISL6118 and the PPTC by driving TP11 to +6V, causing SW1 to close and a nominal 0.94mA load is imposed. This

represents a current overload to the ISL6118 and is thus quickly current regulated to the 600mA limit. If the OC duration extends beyond the nominal 12ms of the internal ISL6118 timer then the output is latched off and the fault output is asserted by being pulled low turning on the appropriate FAULT LED. (Please note: the labeling for the FAULT-1 and FAULT-2 is reversed) The eval board is designed to only invoke an OC condition on channel 2 (TP4) so that a channel to channel isolation evaluation in the presence of an OC condition can be evaluated.

The primary function of any OC protection device is to quickly isolate the voltage bus from a faulty load. Unlike the PPTC and other vendor available IC products, the ISL6118 internal timer that starts upon OC detection provides consistent protection that is independent of temperature. Figures 11 through 13 illustrate the comparative efficiency and effectiveness of the ISL6118 vs the PPTC in protecting and isolating a faulty load capable from drooping the system bus in that system.

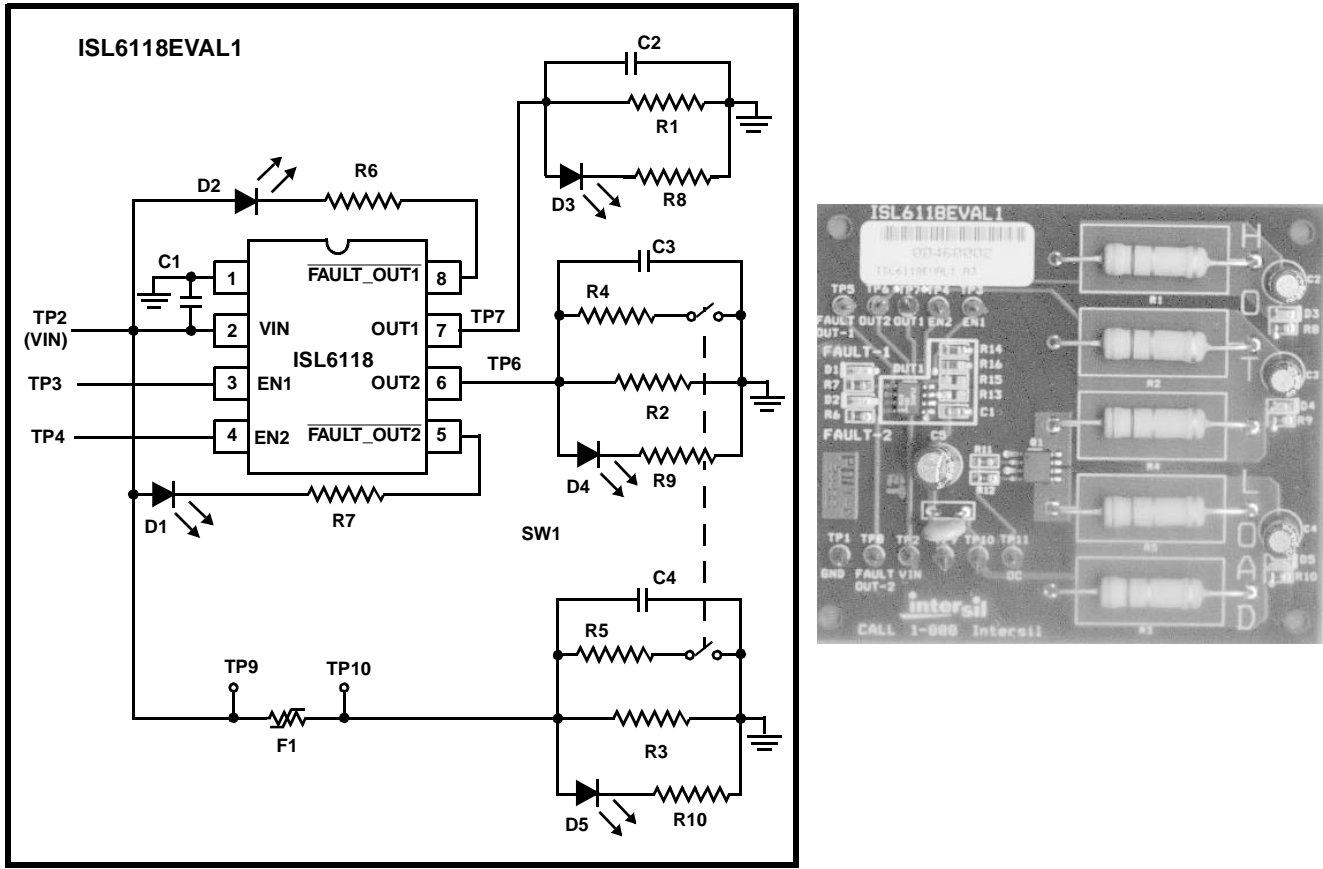

FIGURE 14. ISL6118EVAL1 SCHEMATIC AND PHOTOGRAPH

TABLE 2. ISL6118EVAL1 BOARD COMPONENT LISTING

COMPONENT DESIGNATOR	COMPONENT FUNCTION	COMPONENT DESCRIPTION
DUT1	ISL6118	Intersil, ISL6118HIB 3.3V Aux Hot Plug Controller
R1 - R3	410mA Nominal Load Resistors	YAGEO, 8Ω, 5%, 2W, 8W-2-ND
R4 - R5	970mA Current Over Load Resistors	YAGEO, 6Ω, 5%, 2W, 6W-2-ND
R6 - R10	LED Current Limiting Resistor	470Ω, 0805
C1	Decoupling Capacitor	0.1μF, 0805
C2 - C4	Load Capacitor	100μF, 16V Electrolytic, Radial lead
D1 - D5	Indicating LEDs	0805, SMD LEDs Red
F1	PPTC (Polymer Positive Temperature Coefficient)	Raychem, Poly Switch, RXE040 or Equivalent
SW1(Q1)	Current Over Load Invoking Switch Access TP11	Fairchild, ITF86110DK8T, 7.5A, 30V, 0.025 Ω, Dual N-channel, Logic Level Power MOSFET

Implementing Autoreset on the ISL6118H Hot Swap Controllers.

Abstract

In applications where the cost, complexity or requirement for a system controller is avoided and an autonomous power control function is desired, a device that can monitor and protect against excessive current failures is needed. This shows how to implement such an autonomous controller using the ISL6118HIB. This application works only with the 'H' version of these devices. The 'H' version refers to the enable function being asserted upon a high input.

Introduction

The ISL6118, ISL6119 and ISL6121 are all 2.5V to 5V power supply controllers, each having a different level of current regulation (CR). The ISL6118 and ISL6119 have 2 independent controllers with CR levels of 0.6A and 1.0A respectively whereas the ISL6121 is a single supply controller with a 2A CR level. Each of these devices features integrated power switch(es) for power control. Each switch is driven by a constant current source giving a controlled ramp up of the output voltage. This provides a soft start turn-on eliminating bus voltage drooping caused by in-rush current while charging heavy load capacitances. The independent enabling inputs and fault reporting outputs for each channel are available and necessary for the autonomous autoreset application.

The undervoltage (UV) feature prevents turn-on of the outputs unless the ENABLE pin and VIN are > 2.5V. During initial turn-on the ISL6118 prevents fault reporting by blanking the fault signal. Rising and falling outputs are current-limited voltage ramps so that both the inrush current and voltage slew rate are limited, independent of load. This reduces supply droop due to surge and eliminates the need for external EMI filters. During operation, once an OC condition is detected the appropriate output is current limited to the appropriate level for 10ms to allow transient conditions to pass. If still in current limit after the current limit period has elapsed, the output is latched off and the fault is reported by pulling the corresponding $\overline{\text{FAULT}}$ low. The $\overline{\text{FAULT}}$ signal is latched low until reset by the ENABLE signal being de-asserted at which time the $\overline{\text{FAULT}}$ signal will clear.

It is this described sequence of events that allows for the autoreset function to be implemented in a cost efficient manner requiring the addition of only an RC network per channel to the typical application.

Figure 15 illustrates the RC network needed with suggested component values and the configuration of the relevant pins for each autoreset channel.

Description of Operation

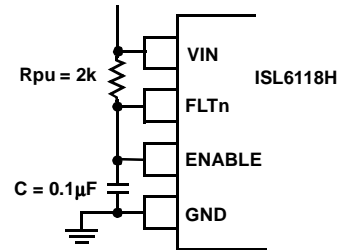

FIGURE 15.

Initially as voltage is applied to VIN, the pull up resistor (R_{pu}) provides for pull up to VIN on both the ENABLE pin asserting the output once $V_{IN} > 2.5V$ and on the FLTn pin. Once turned on and an overcurrent (OC) condition occurs the IC provides CR protection for 10ms and then the FLTn pin pulls low through R_{pu} and also pulling the ENABLE low thus resetting the device fault condition. At this time the R_{pu} charges the cap and the voltage on the ENABLE / FLTn node rises until the ENABLE > 2.0 and the output is asserted on once again. This automatic reset cycle will continue until the OC fault no longer exists on the output. After several seconds in this mode of operation the IC thermal protection invokes adjusting the timing of the on-off cycle to prevent excessive thermal dissipation in the power switch protecting itself and surrounding circuitry. See Figure 16 for operation waveform.

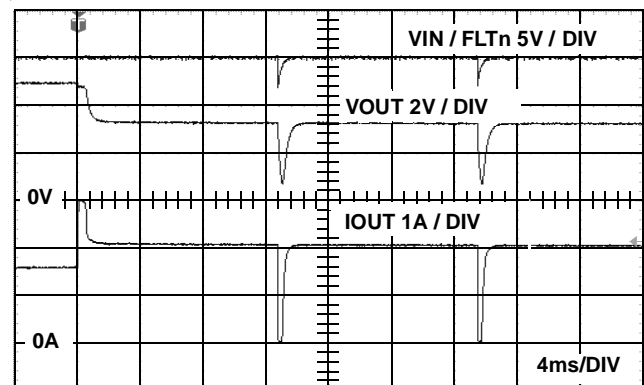
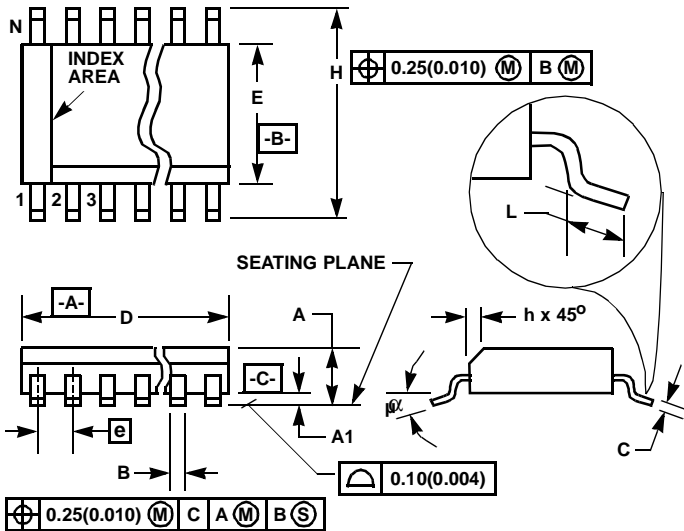

FIGURE 16. AUTO RESET OPERATION

Applications

- USB
- 2.5V to 5V up to 10W power port protection

Small Outline Plastic Packages (SOIC)



**M8.15 (JEDEC MS-012-AA ISSUE C)
8 LEAD NARROW BODY SMALL OUTLINE PLASTIC
PACKAGE**

SYMBOL	INCHES		MILLIMETERS		NOTES
	MIN	MAX	MIN	MAX	
A	0.0532	0.0688	1.35	1.75	-
A1	0.0040	0.0098	0.10	0.25	-
B	0.013	0.020	0.33	0.51	9
C	0.0075	0.0098	0.19	0.25	-
D	0.1890	0.1968	4.80	5.00	3
E	0.1497	0.1574	3.80	4.00	4
e	0.050 BSC		1.27 BSC		-
H	0.2284	0.2440	5.80	6.20	-
h	0.0099	0.0196	0.25	0.50	5
L	0.016	0.050	0.40	1.27	6
N	8		8		7
α	0°	8°	0°	8°	-

NOTES:

1. Symbols are defined in the "MO Series Symbol List" in Section 2.2 of Publication Number 95.
2. Dimensioning and tolerancing per ANSI Y14.5M-1982.
3. Dimension "D" does not include mold flash, protrusions or gate burrs. Mold flash, protrusion and gate burrs shall not exceed 0.15mm (0.006 inch) per side.
4. Dimension "E" does not include interlead flash or protrusions. Interlead flash and protrusions shall not exceed 0.25mm (0.010 inch) per side.
5. The chamfer on the body is optional. If it is not present, a visual index feature must be located within the crosshatched area.
6. "L" is the length of terminal for soldering to a substrate.
7. "N" is the number of terminal positions.
8. Terminal numbers are shown for reference only.
9. The lead width "B", as measured 0.36mm (0.014 inch) or greater above the seating plane, shall not exceed a maximum value of 0.61mm (0.024 inch).
10. Controlling dimension: MILLIMETER. Converted inch dimensions are not necessarily exact.

Rev. 0 12/93

All Intersil products are manufactured, assembled and tested utilizing ISO9000 quality systems. Intersil Corporation's quality certifications can be viewed at website www.intersil.com/design/quality

Intersil products are sold by description only. Intersil Corporation reserves the right to make changes in circuit design and/or specifications at any time without notice. Accordingly, the reader is cautioned to verify that data sheets are current before placing orders. Information furnished by Intersil is believed to be accurate and reliable. However, no responsibility is assumed by Intersil or its subsidiaries for its use; nor for any infringements of patents or other rights of third parties which may result from its use. No license is granted by implication or otherwise under any patent or patent rights of Intersil or its subsidiaries.

For information regarding Intersil Corporation and its products, see web sit www.intersil.com

Sales Office Headquarters

NORTH AMERICA
Intersil Corporation
2401 Palm Bay Road
Palm Bay, FL 32905
TEL: (321) 724-7000
FAX: (321) 724-7240

EUROPE
Intersil SA
Mercure Center
100, Rue de la Fusee
1130 Brussels, Belgium
TEL: (32) 2.724.2111
FAX: (32) 2.724.22.05

ASIA
Intersil Ltd.
8F-2, 96, Sec. 1, Chien-kuo North,
Taipei, Taiwan 104
Republic of China
TEL: 886-2-2515-8508
FAX: 886-2-2515-8369