



# 0.4" Seven-Segment Numeric LED Display

LTS-4X01A

LTD-4000 Series

LTC-4000

## Features

- 0.4 inch (10.0mm) digit height.
- Choices of five bright colors: AlGaAs red/bright red/green/yellow/red orange.
- Low power requirement.
- Excellent characters appearance.
- Categorized for luminous intensity.
- I.C. compatible.
- Easy mounting on P.C. board or socket.

## Descriptions

The LTS-4X01A, LTD-4000, LTC-4000 series are 0.4 inch (10.0mm) height single, dual, triple and quadruple digit displays. These devices have gray face and white segments.

The AlGaAs red seven segment displays are designed for applications requiring low power consumption. They are tested and selected for the excellent low current characteristics to ensure that the segments are matched at low current. Drive current as low as 1 mA per segment is available.

The AlGaAs red series devices utilize LED chips which are made from AlGaAs on a non-transparent GaAs substrate. The bright red and green series devices utilize LED chips which are made from GaP on a transparent GaP substrate. The yellow and red orange series devices utilize LED chips which are made from GaAsP on a transparent GaP substrate. All devices have gray face and white segments.

## Package Dimensions

A.LTS-4301/4801

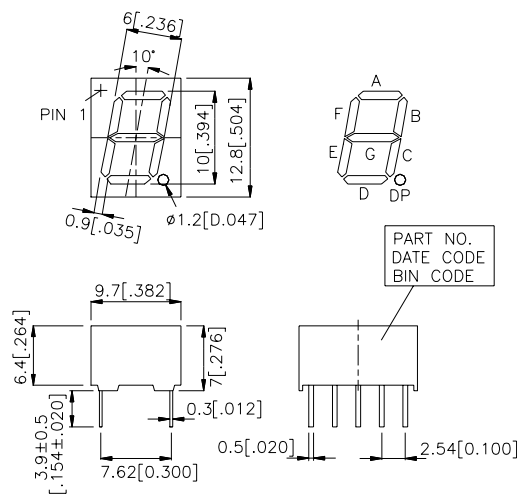

B.LTD-4608/4708

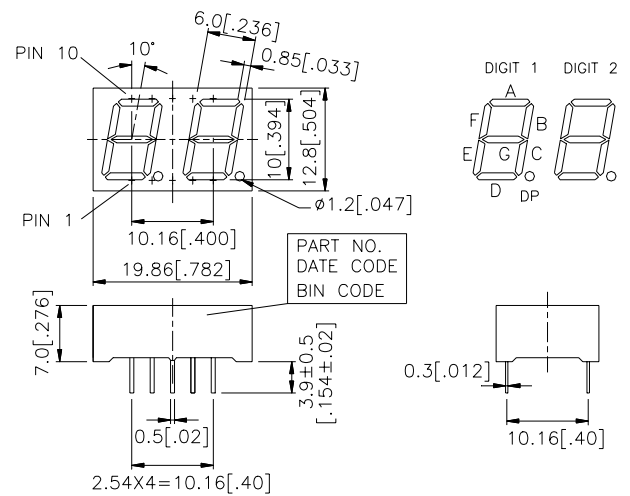

### C.LTC-4624/4724

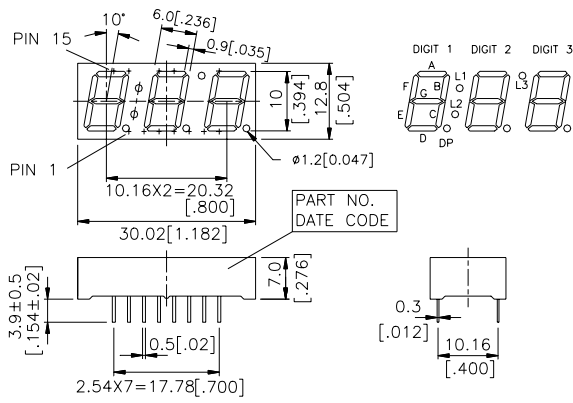

### D.LTC-4627/4727

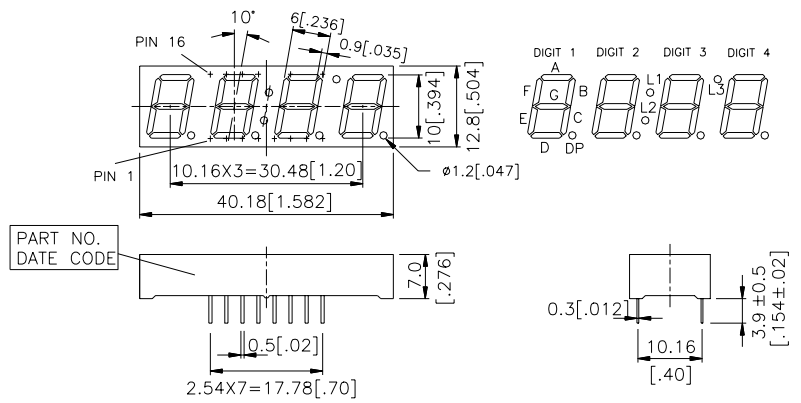

Notes: All dimensions are in millimeters (inches). Tolerance: ± 0.25mm (0.01") unless otherwise noted.

### Devices

Part No.					Description	Package Dimension	Internal Circuit Diagram
AlGaAs Red	Bright Red	Green	Yellow	Red Orange			
LTS-4301WC	4301P	4301G	4301Y	4301E	Common Cathode, Rt. Hand Decimal	A	A
LTS-4801WC	4801P	4801G	4801Y	4801E	Common Anode, Rt. Hand Decimal	A	B
LTD-4608WC	4608P	4608G	4608Y	4608E	Dualplex Common Anode, Rt. Hand Decimal	B	C
LTD-4708WC	4708P	4708G	4708Y	4708E	Dualplex Common Cathode, Rt. Hand Decimal	B	D
LTC-4624WC	4624P	4624G	4624Y	4624E	Multiplex Common Anode, Rt. Hand Decimal	C	E
LTC-4724WC	4724P	4724G	4724Y	4724E	Multiplex Common Cathode, Rt. Hand Decimal	C	F
LTC-4627WC	4627P	4627G	4627Y	4627E	Multiplex Common Anode, Rt. Hand Decimal	D	G
LTC-4727WC	4727P	4727G	4727Y	4727E	Multiplex Common Cathode, Rt. Hand Decimal	D	H

### Pin Connection

Pin No.	Connection	
	A.LTS-4301	B.LTS-4801
1.	Anode G	Cathode G
2.	Anode F	Cathode F
3.	Common Cathode	Common Anode
4.	Anode E	Cathode E
5.	Anode D	Cathode D
6.	Anode D.P.	Cathode D.P.
7.	Anode C	Cathode C
8.	Common Cathode	Common Anode
9.	Anode B	Cathode B
10.	Anode A	Cathode A

Pin No.	Connection	
	C.LTD-4608	D.LTD-4708
1.	Cathode C	Anode C
2.	Cathode D.P.	Anode D.P.
3.	Cathode E	Anode E
4.	Common Anode Digit 2	Common Cathode Digit 2
5.	Cathode D	Anode D
6.	Cathode F	Anode F
7.	Cathode G	Anode G
8.	Cathode B	Anode B
9.	Common Anode Digit 1	Common Cathode Digit 1
10.	Cathode A	Anode A

Pin No.	Connection	
	E.LTC-4624	F.LTC-4724
1.	Common Anode Digit 1	Common Cathode Digit 1
2.	Cathode E	Anode E
3.	Cathode C, L3	Anode C, L3
4.	Cathode D	Anode D
5.	Common Anode Digit 2	Common Cathode Digit 2
6.	Cathode D.P.	Anode D.P.
7.	Common Anode Digit 3	Common Cathode Digit 3
8.	Cathode G	Anode G
9.	No Pin	No Pin
10.	No Pin	No Pin
11.	Cathode B, L2	Anode B, L2
12.	Cathode A, L1	Anode A, L1
13.	No Pin	No Pin
14.	Common Anode L1, L2, L3	Common Cathode L1, L2, L3
15.	Cathode F	Anode F

Pin No.	Connection	
	G.LTC-4627	H.LTC-4727
1.	Common Anode Digit 1	Common Cathode Digit 1
2.	Common Anode Digit 2	Common Cathode Digit 2
3.	Cathode D	Anode D
4.	Common Anode L1, L2, L3	Common Cathode L1, L2, L3
5.	Cathode E	Anode E
6.	Common Anode Digit 3	Common Cathode Digit 3
7.	Cathode D.P.	Anode D.P.
8.	Common Anode Digit 4	Common Cathode Digit 4
9.	No Connection	No Connection
10.	No Pin	No Pin
11.	Cathode F	Anode F
12.	No Pin	No Pin
13.	Cathode C, L3	Anode C, L3
14.	Cathode A, L1	Anode A, L1
15.	Cathode G	Anode G
16.	Cathode B, L2	Anode B, L2

## Internal Circuit Diagrams

A.LTS-4301

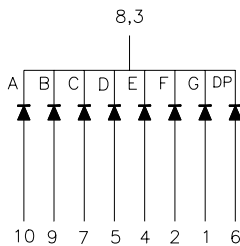

B.LTS-4801

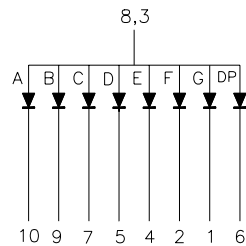

C.LTD-4608

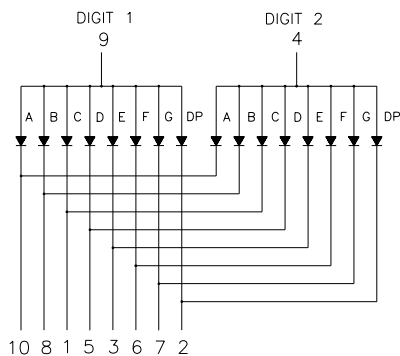

D.LTD-4708

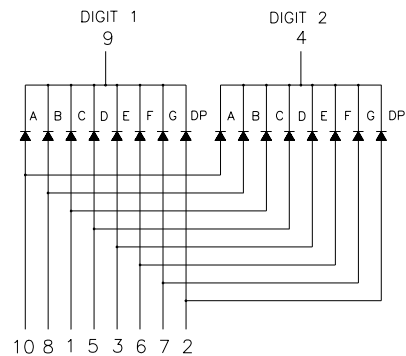

E.LTC-4624

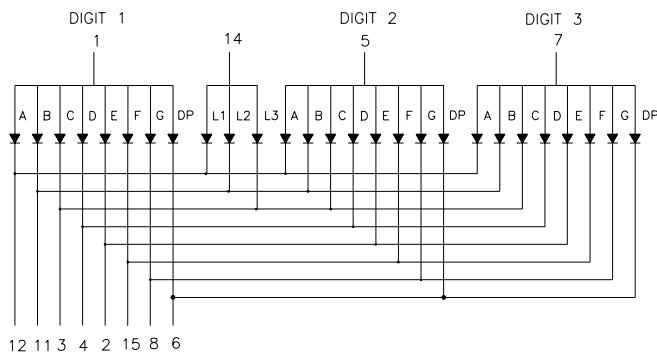

F.LTC-4724

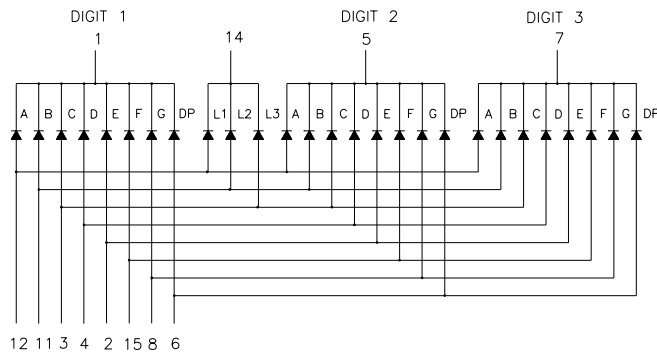

G.LTC-4627

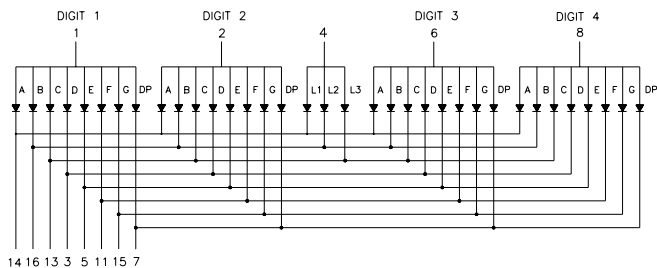

H.LTC-4727

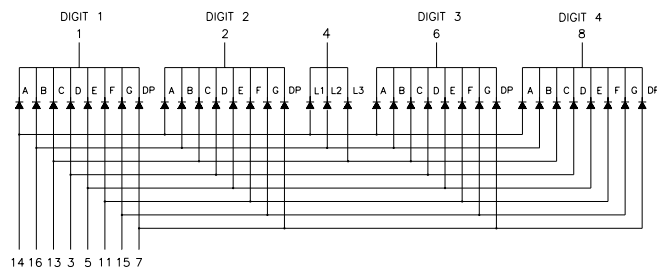

### Absolute Maximum Rating at Ta=25°C

Parameter	AlGaAs Red	Bright Red	Green	Yellow	Red Orange	Unit
Power Dissipation Per Segment	75	40	75	60	75	mW
Peak Forward Current Per Segment (1/10 Duty Cycle, 0.1ms Pulse Width)	125	60	100	80	100	mA
Continuous Forward Current Per Segment Derating Linear from 25°C Per Segment	30	15	25	20	25	mA
Reverse Voltage Per Segment	0.4	0.2	0.33	0.27	0.33	mA/°C
Operating Temperature Range	-35°C to +85°C					
Storage Temperature Range	-35°C to +85°C					
Solder Temperature 1/16 Inch Below Seating Plane for 3 Seconds at 260°C						

### Electrical/Optical Characteristics at Ta=25°C

LTS-4301WC/4801WC/LTD-4608WC/4708WC/LTC-4624WC/4724WC/4627WC/4727WC

Parameter	Symbol	Min.	Typ.	Max.	Unit	Tset Condition
Average Luminous Intensity	Iv	200	650		μ cd	If=1mA
			3400			If=5mA
Peak Emission Wavelength	λ P		660		nm	If=20mA
Spectral Line Half-Width	Δλ		35		nm	If=20mA
Dominant Wavelength	λ d		638		nm	If=20mA
Forward Voltage, Per Segment	VF		1.6	2.4	V	If=1mA
			1.7			If=5mA
			1.8			If=20mA
Reverse Current, Per Segment	IR			100	μ A	VR=5V
Luminous Intensity Matching Ratio	Iv-m			2:1		If=10mA

## LTS-4301P/4801P/LTD-4608P/4708P/LTC-4624P/4724P/4627P/4727P

Parameter	Symbol	Min.	Typ.	Max.	Unit	Tset Condition
Average Luminous Intensity	I <sub>v</sub>	320	800		μ cd	I <sub>F</sub> =10mA
Peak Emission Wavelength	λ P		697		nm	I <sub>F</sub> =20mA
Spectral Line Half-Width	Δ λ		90		nm	I <sub>F</sub> =20mA
Dominant Wavelength	λ d		657		nm	I <sub>F</sub> =20mA
Forward Voltage, Per Segment or D.P.	V <sub>F</sub>		2.1	2.6	V	I <sub>F</sub> =20mA
Reverse Current, Per Segment or D.P.	I <sub>R</sub>			100	μ A	V <sub>R</sub> =5V
Luminous Intensity Matching Ratio	I <sub>v</sub> -m			2:1		I <sub>F</sub> =10mA

## LTS-4301G/4801G/LTD-4608G/4708G/LTC-4624G/4724G/4627G/4727G

Parameter	Symbol	Min.	Typ.	Max.	Unit	Tset Condition
Average Luminous Intensity	I <sub>v</sub>	800	2200		μ cd	I <sub>F</sub> =10mA
Peak Emission Wavelength	λ P		565		nm	I <sub>F</sub> =20mA
Spectral Line Half-Width	Δ λ		30		nm	I <sub>F</sub> =20mA
Dominant Wavelength	λ d		569		nm	I <sub>F</sub> =20mA
Forward Voltage, Per Segment or D.P.	V <sub>F</sub>		2.1	2.6	V	I <sub>F</sub> =20mA
Reverse Current, Per Segment or D.P.	I <sub>R</sub>			100	μ A	V <sub>R</sub> =5V
Luminous Intensity Matching Ratio	I <sub>v</sub> -m			2:1		I <sub>F</sub> =10mA

## LTS-4301Y/4801Y/LTD-4608Y/4708Y/LTC-4624Y/4724Y/4627Y/4727Y

Parameter	Symbol	Min.	Typ.	Max.	Unit	Tset Condition
Average Luminous Intensity	I <sub>v</sub>	800	2200		μ cd	I <sub>F</sub> =10mA
Peak Emission Wavelength	λ P		585		nm	I <sub>F</sub> =20mA
Spectral Line Half-Width	Δ λ		35		nm	I <sub>F</sub> =20mA
Dominant Wavelength	λ d		588		nm	I <sub>F</sub> =20mA
Forward Voltage, Per Segment or D.P.	V <sub>F</sub>		2.1	2.6	V	I <sub>F</sub> =20mA
Reverse Current, Per Segment or D.P.	I <sub>R</sub>			100	μ A	V <sub>R</sub> =5V
Luminous Intensity Matching Ratio	I <sub>v</sub> -m			2:1		I <sub>F</sub> =10mA

## LTS-4301E/4801E/LTD-4608E/4708E/LTC-4624E/4724E/4627E/4727E

Parameter	Symbol	Min.	Typ.	Max.	Unit	Tset Condition
Average Luminous Intensity	I <sub>v</sub>	800	2200		μ cd	I <sub>F</sub> =10mA
Peak Emission Wavelength	λ P		630		nm	I <sub>F</sub> =20mA
Spectral Line Half-Width	Δ λ		40		nm	I <sub>F</sub> =20mA
Dominant Wavelength	λ d		621		nm	I <sub>F</sub> =20mA
Forward Voltage, Per Segment or D.P.	V <sub>F</sub>		2.0	2.6	V	I <sub>F</sub> =20mA
Reverse Current, Per Segment or D.P.	I <sub>R</sub>			100	μ A	V <sub>R</sub> =5V
Luminous Intensity Matching Ratio	I <sub>v</sub> -m			2:1		I <sub>F</sub> =10mA

Note: Luminous intensity is measured with a light sensor and filter combination that approximates the CIE (Commission Internationale De L'Eclairage) eye-response curve.

# Typical Electrical/Optical Characteristic Curves (25°C Ambient Temperature Unless Otherwise Noted)

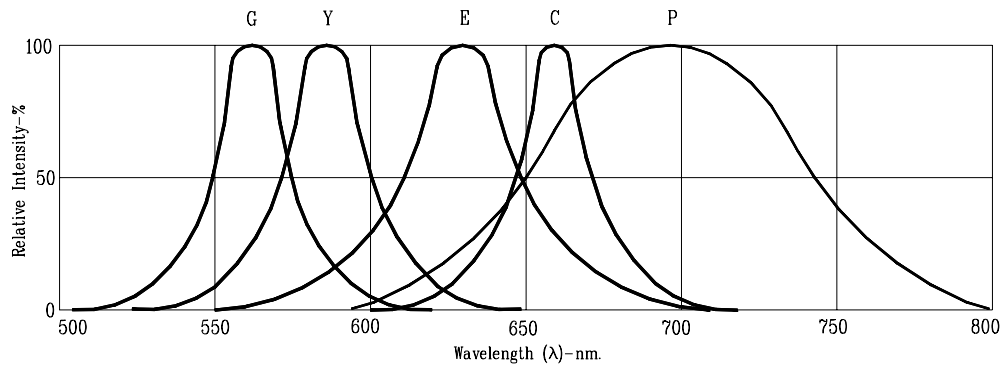

Fig1. RELATIVE INTENSITY VS. WAVELENGTH

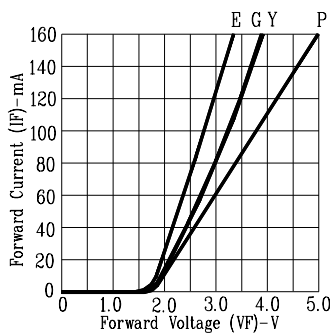

Fig2. FORWARD CURRENT VS. FORWARD VOLTAGE

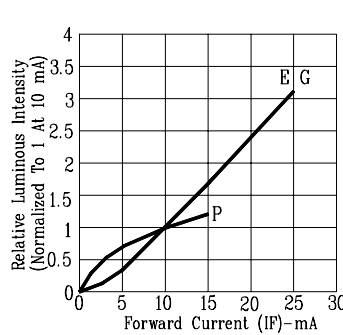

Fig3. RELATIVE LUMINOUS INTENSITY VS. FORWARD CURRENT

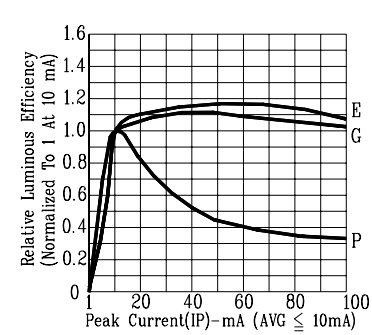

Fig4. RELATIVE LUMINOUS EFFICIENCY (LUMINOUS INTENSITY PER UNIT CURRENT) VS. PEAK CURRENT

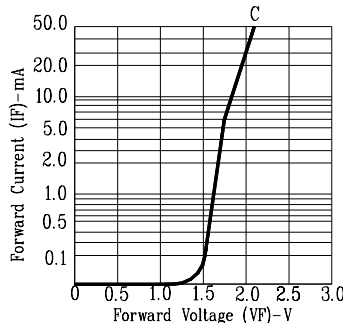

Fig5. FORWARD CURRENT VS. FORWARD VOLTAGE

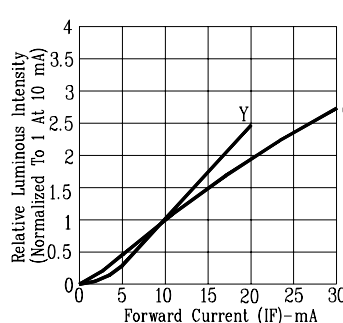

Fig6. RELATIVE LUMINOUS INTENSITY VS. FORWARD CURRENT

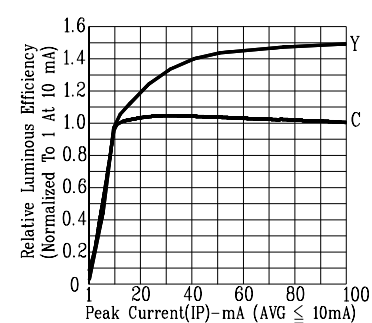

Fig7. RELATIVE LUMINOUS EFFICIENCY (LUMINOUS INTENSITY PER UNIT CURRENT) VS. PEAK CURRENT

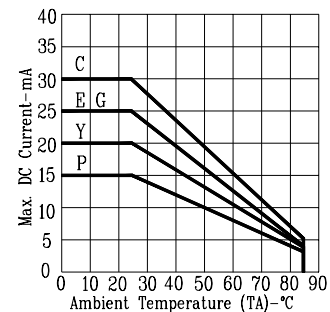

Fig8. MAX. ALLOWABLE DC CURRENT VS. AMBIENT TEMPERATURE.

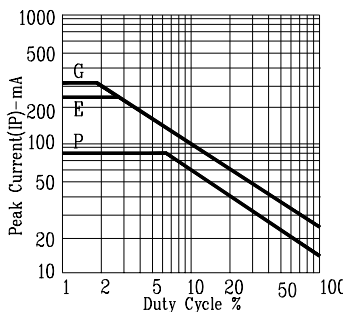

Fig9. MAX. PEAK CURRENT VS. DUTY CYCLE % (REFRESH RATE 1KHz)

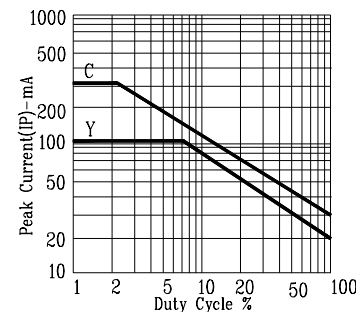

Fig10. MAX. PEAK CURRENT VS. DUTY CYCLE % (REFRESH RATE 1KHz)

NOTE: C=AlGaAs RED P=BRIGHT RED G=GREEN E=RED ORANGE Y=YELLOW (REFRESH RATE 1KHz)