

# Complementary Power Transistors

## DPAK For Surface Mount Applications

Designed for general purpose amplifier and low speed switching applications.

- Lead Formed for Surface Mount Applications in Plastic Sleeves (No Suffix)
- Straight Lead Version in Plastic Sleeves ("–1" Suffix)
- Lead Formed Version in 16 mm Tape and Reel ("T4" Suffix)
- Electrically Similar to Popular TIP31 and TIP32 Series

### MAXIMUM RATINGS

Rating	Symbol	MJD31 MJD32	MJD31C MJD32C	Unit
Collector–Emitter Voltage	$V_{CEO}$	40	100	Vdc
Collector–Base Voltage	$V_{CB}$	40	100	Vdc
Emitter–Base Voltage	$V_{EB}$	5		Vdc
Collector Current — Continuous Peak	$I_C$	3 5		Adc
Base Current	$I_B$	1		Adc
Total Power Dissipation @ $T_C = 25^\circ\text{C}$ Derate above $25^\circ\text{C}$	$P_D$	15 0.12		Watts W/ $^\circ\text{C}$
Total Power Dissipation* @ $T_A = 25^\circ\text{C}$ Derate above $25^\circ\text{C}$	$P_D$	1.56 0.012		Watts W/ $^\circ\text{C}$
Operating and Storage Junction Temperature Range	$T_J, T_{stg}$	–65 to +150		$^\circ\text{C}$

### THERMAL CHARACTERISTICS

Characteristic	Symbol	Max	Unit
Thermal Resistance, Junction to Case	$R_{\theta JC}$	8.3	$^\circ\text{C/W}$
Thermal Resistance, Junction to Ambient*	$R_{\theta JA}$	80	$^\circ\text{C/W}$
Lead Temperature for Soldering Purposes	$T_L$	260	$^\circ\text{C}$

\* These ratings are applicable when surface mounted on the minimum pad size recommended.

**NPN**  
**MJD31,C\***  
**PNP**  
**MJD32,C\***

\*Motorola Preferred Device

**SILICON**  
**POWER TRANSISTORS**  
**3 AMPERES**  
**40 AND 100 VOLTS**  
**15 WATTS**



CASE 369A–13

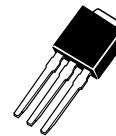

CASE 369–07

### MINIMUM PAD SIZES RECOMMENDED FOR SURFACE MOUNTED APPLICATIONS

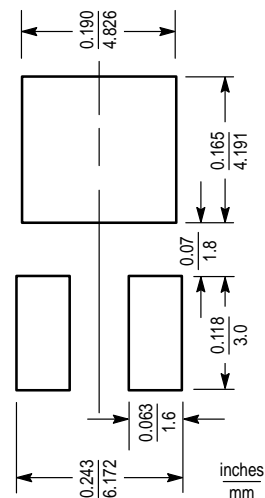

Preferred devices are Motorola recommended choices for future use and best overall value.

REV 1

© Motorola, Inc. 1995



## MJD31,C MJD32,C

### ELECTRICAL CHARACTERISTICS ( $T_C = 25^\circ\text{C}$ unless otherwise noted)

Characteristic	Symbol	Min	Max	Unit
<b>OFF CHARACTERISTICS</b>				
Collector–Emitter Sustaining Voltage (1) ( $I_C = 30\text{ mA}$ , $I_B = 0$ ) MJD31, MJD32 MJD31C, MJD32C	$V_{CEO(sus)}$	40 100	— —	Vdc
Collector Cutoff Current ( $V_{CE} = 40\text{ Vdc}$ , $I_B = 0$ ) ( $V_{CE} = 60\text{ Vdc}$ , $I_B = 0$ ) MJD31, MJD32 MJD31C, MJD32C	$I_{CEO}$	—	50	$\mu\text{A}$
Collector Cutoff Current ( $V_{CE} = \text{Rated } V_{CEO}$ , $V_{EB} = 0$ )	$I_{CES}$	—	20	$\mu\text{A}$
Emitter Cutoff Current ( $V_{BE} = 5\text{ Vdc}$ , $I_C = 0$ )	$I_{EBO}$	—	1	mA
<b>ON CHARACTERISTICS (1)</b>				
DC Current Gain ( $I_C = 1\text{ A}$ , $V_{CE} = 4\text{ Vdc}$ ) ( $I_C = 3\text{ A}$ , $V_{CE} = 4\text{ Vdc}$ )	$h_{FE}$	25 10	— 50	—
Collector–Emitter Saturation Voltage ( $I_C = 3\text{ A}$ , $I_B = 375\text{ mA}$ )	$V_{CE(sat)}$	—	1.2	Vdc
Base–Emitter On Voltage ( $I_C = 3\text{ A}$ , $V_{CE} = 4\text{ Vdc}$ )	$V_{BE(on)}$	—	1.8	Vdc
<b>DYNAMIC CHARACTERISTICS</b>				
Current Gain — Bandwidth Product (2) ( $I_C = 500\text{ mA}$ , $V_{CE} = 10\text{ Vdc}$ , $f_{test} = 1\text{ MHz}$ )	$f_T$	3	—	MHz
Small–Signal Current Gain ( $I_C = 0.5\text{ A}$ , $V_{CE} = 10\text{ Vdc}$ , $f = 1\text{ kHz}$ )	$h_{fe}$	20	—	—

(1) Pulse Test: Pulse Width  $\leq 300\ \mu\text{s}$ , Duty Cycle  $\leq 2\%$ .

(2)  $f_T = |h_{fe}| \cdot f_{test}$ .

TYPICAL CHARACTERISTICS

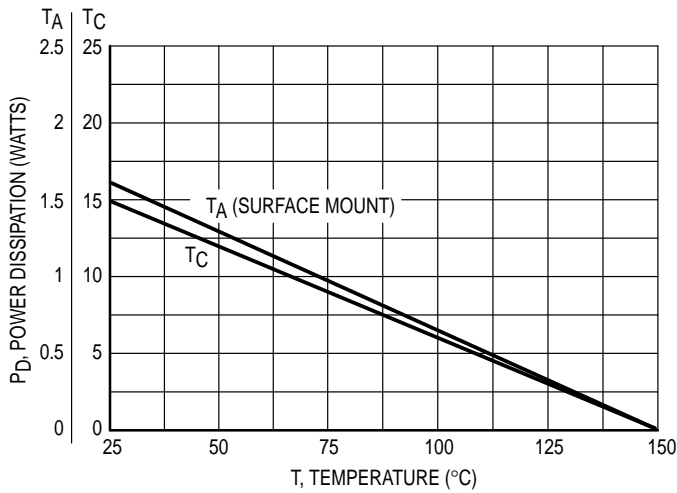
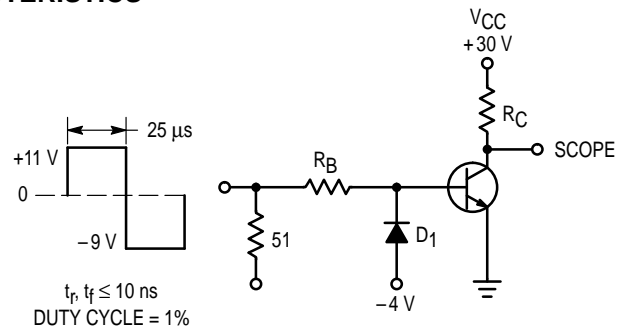

Figure 1. Power Derating



$R_B$  and  $R_C$  VARIED TO OBTAIN DESIRED CURRENT LEVELS  
 $D_1$  MUST BE FAST RECOVERY TYPE, e.g.:  
 1N5825 USED ABOVE  $I_B \approx 100$  mA  
 MSD6100 USED BELOW  $I_B \approx 100$  mA  
 REVERSE ALL POLARITIES FOR PNP.

Figure 2. Switching Time Test Circuit

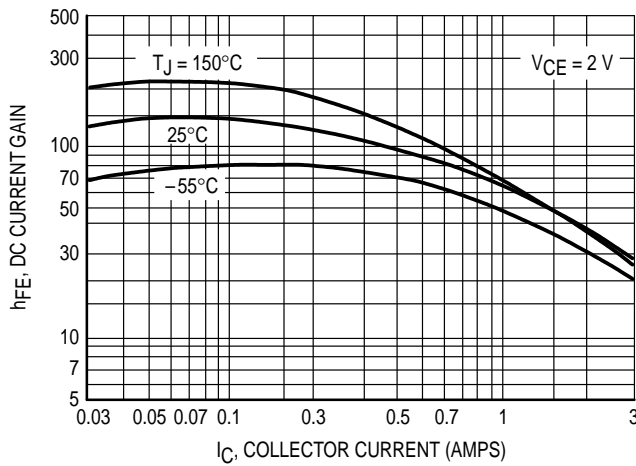

Figure 3. DC Current Gain

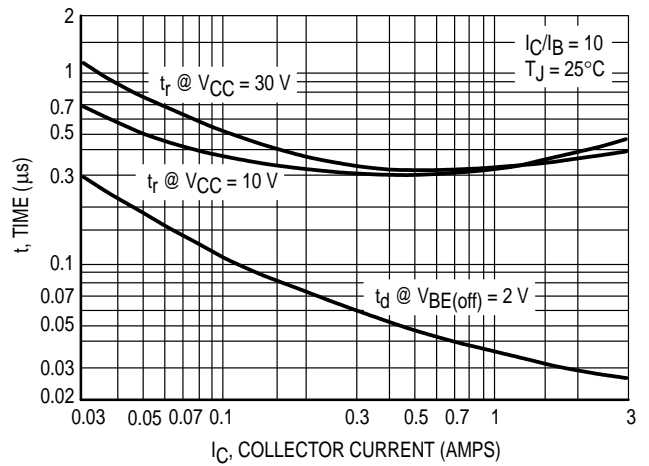

Figure 4. Turn-On Time

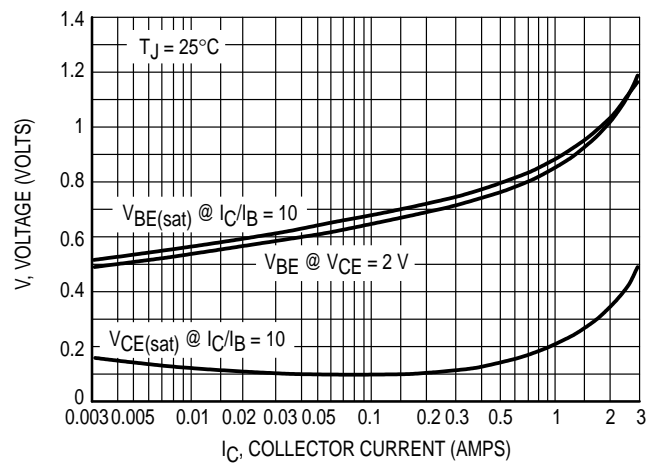

Figure 5. "On" Voltages

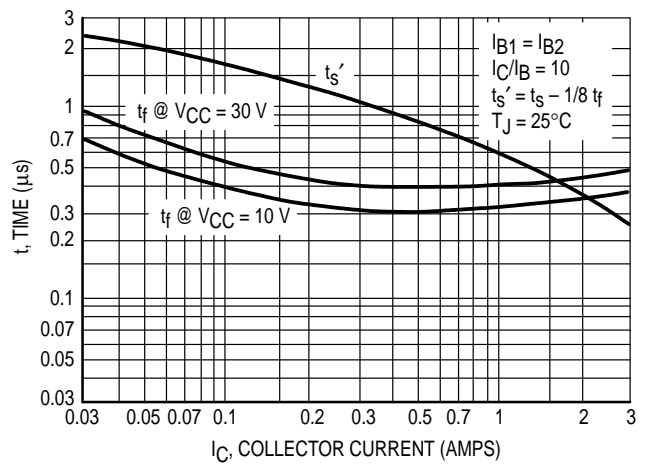

Figure 6. Turn-Off Time

# MJD31,C MJD32,C

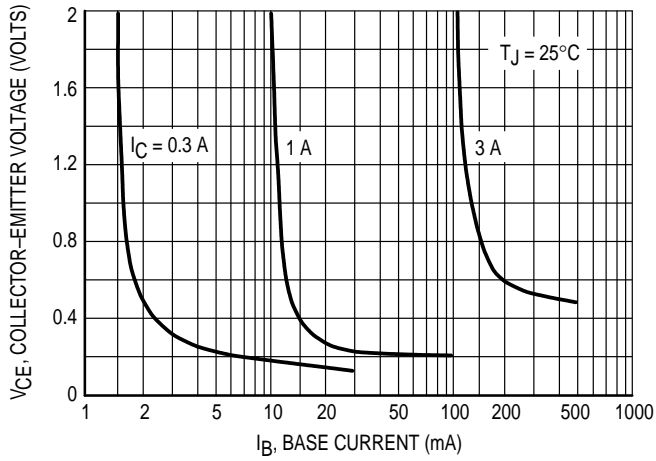

Figure 7. Collector Saturation Region

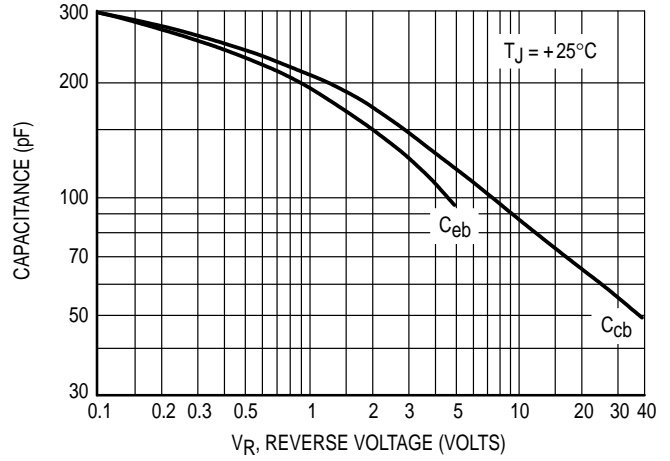

Figure 8. Capacitance

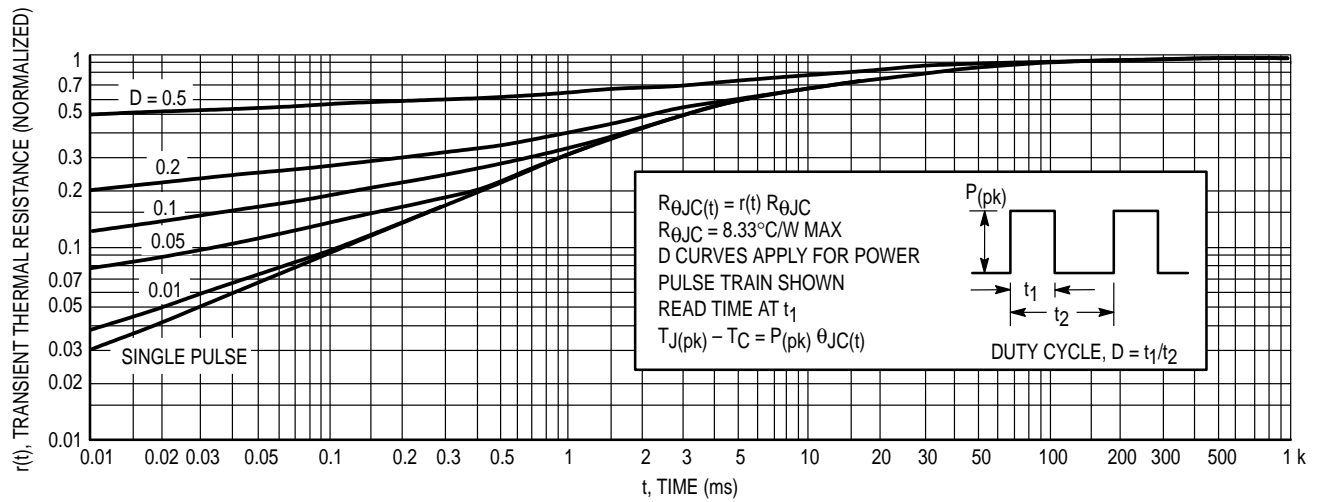

Figure 9. Thermal Response

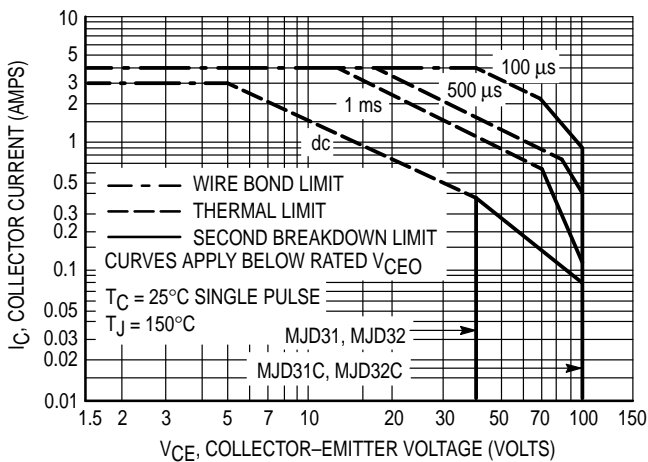
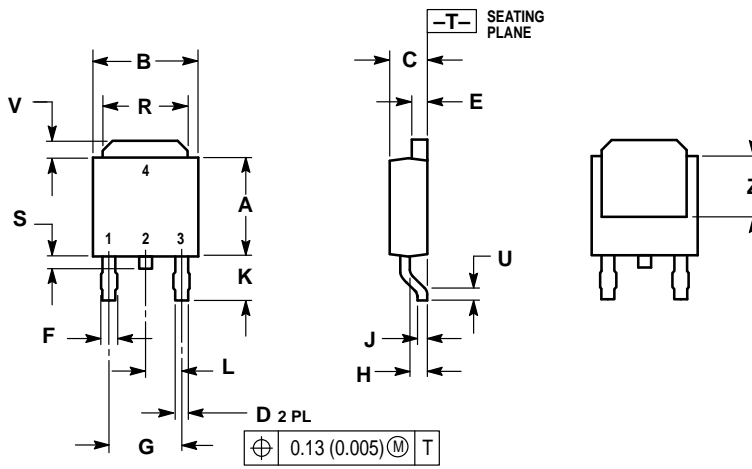

Figure 10. Active Region Safe Operating Area

There are two limitations on the power handling ability of a transistor: average junction temperature and second breakdown. Safe operating area curves indicate  $I_C - V_{CE}$  limits of the transistor that must be observed for reliable operation; i.e., the transistor must not be subjected to greater dissipation than the curves indicate.

The data of Figure 10 is based on  $T_{J(pk)} = 150^\circ\text{C}$ ;  $T_C$  is variable depending on conditions. Second breakdown pulse limits are valid for duty cycles to 10% provided  $T_{J(pk)} \leq 150^\circ\text{C}$ .  $T_{J(pk)}$  may be calculated from the data in Figure 9. At high case temperatures, thermal limitations will reduce the power that can be handled to values less than the limitations imposed by second breakdown.

PACKAGE DIMENSIONS



- NOTES:  
 1. DIMENSIONING AND TOLERANCING PER ANSI Y14.5M, 1982.  
 2. CONTROLLING DIMENSION: INCH.

DIM	INCHES		MILLIMETERS	
	MIN	MAX	MIN	MAX
A	0.235	0.250	5.97	6.35
B	0.250	0.265	6.35	6.73
C	0.086	0.094	2.19	2.38
D	0.027	0.035	0.69	0.88
E	0.033	0.040	0.84	1.01
F	0.037	0.047	0.94	1.19
G	0.180 BSC		4.58 BSC	
H	0.034	0.040	0.87	1.01
J	0.018	0.023	0.46	0.58
K	0.102	0.114	2.60	2.89
L	0.090 BSC		2.29 BSC	
R	0.175	0.215	4.45	5.46
S	0.020	0.050	0.51	1.27
U	0.020	—	0.51	—
V	0.030	0.050	0.77	1.27
Z	0.138	—	3.51	—

- STYLE 1:  
 PIN 1. BASE  
 2. COLLECTOR  
 3. EMITTER  
 4. COLLECTOR

CASE 369A-13  
 ISSUE W

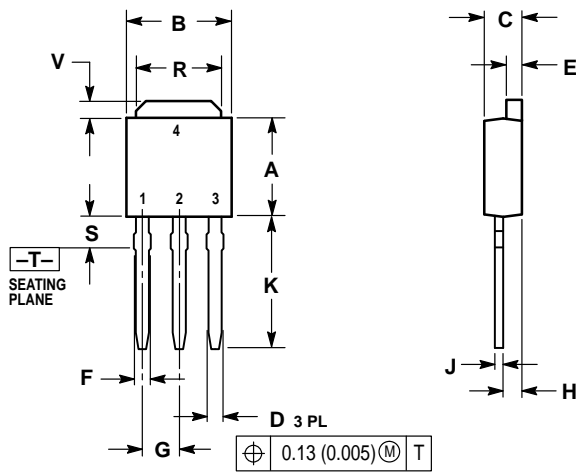

- NOTES:  
 1. DIMENSIONING AND TOLERANCING PER ANSI Y14.5M, 1982.  
 2. CONTROLLING DIMENSION: INCH.

DIM	INCHES		MILLIMETERS	
	MIN	MAX	MIN	MAX
A	0.235	0.250	5.97	6.35
B	0.250	0.265	6.35	6.73
C	0.086	0.094	2.19	2.38
D	0.027	0.035	0.69	0.88
E	0.033	0.040	0.84	1.01
F	0.037	0.047	0.94	1.19
G	0.090 BSC		2.29 BSC	
H	0.034	0.040	0.87	1.01
J	0.018	0.023	0.46	0.58
K	0.350	0.380	8.89	9.65
R	0.175	0.215	4.45	5.46
S	0.050	0.090	1.27	2.28
V	0.030	0.050	0.77	1.27

- STYLE 1:  
 PIN 1. BASE  
 2. COLLECTOR  
 3. EMITTER  
 4. COLLECTOR

CASE 369-07  
 ISSUE K

Motorola reserves the right to make changes without further notice to any products herein. Motorola makes no warranty, representation or guarantee regarding the suitability of its products for any particular purpose, nor does Motorola assume any liability arising out of the application or use of any product or circuit, and specifically disclaims any and all liability, including without limitation consequential or incidental damages. "Typical" parameters can and do vary in different applications. All operating parameters, including "Typicals" must be validated for each customer application by customer's technical experts. Motorola does not convey any license under its patent rights nor the rights of others. Motorola products are not designed, intended, or authorized for use as components in systems intended for surgical implant into the body, or other applications intended to support or sustain life, or for any other application in which the failure of the Motorola product could create a situation where personal injury or death may occur. Should Buyer purchase or use Motorola products for any such unintended or unauthorized application, Buyer shall indemnify and hold Motorola and its officers, employees, subsidiaries, affiliates, and distributors harmless against all claims, costs, damages, and expenses, and reasonable attorney fees arising out of, directly or indirectly, any claim of personal injury or death associated with such unintended or unauthorized use, even if such claim alleges that Motorola was negligent regarding the design or manufacture of the part. Motorola and  are registered trademarks of Motorola, Inc. Motorola, Inc. is an Equal Opportunity/Affirmative Action Employer.

**How to reach us:**

**USA / EUROPE:** Motorola Literature Distribution;  
P.O. Box 20912; Phoenix, Arizona 85036. 1-800-441-2447

**JAPAN:** Nippon Motorola Ltd.; Tatsumi-SPD-JLDC, Toshikatsu Otsuki,  
6F Seibu-Butsuryu-Center, 3-14-2 Tatsumi Koto-Ku, Tokyo 135, Japan. 03-3521-8315

**MFAX:** RMFAX0@email.sps.mot.com – TOUCHTONE (602) 244-6609  
**INTERNET:** <http://Design-NET.com>

**HONG KONG:** Motorola Semiconductors H.K. Ltd.; 8B Tai Ping Industrial Park,  
51 Ting Kok Road, Tai Po, N.T., Hong Kong. 852-26629298



**MJD31/D**

