

Complementary Plastic Power Transistors

NPN/PNP Silicon DPAK For Surface Mount Applications

... designed for low voltage, low-power, high-gain audio amplifier applications.

- Collector-Emitter Sustaining Voltage —
 $V_{CEO(sus)} = 25 \text{ Vdc (Min) @ } I_C = 10 \text{ mAdc}$
- High DC Current Gain —
 $h_{FE} = 70 \text{ (Min) @ } I_C = 500 \text{ mAdc}$
 $= 45 \text{ (Min) @ } I_C = 2 \text{ Adc}$
 $= 10 \text{ (Min) @ } I_C = 5 \text{ Adc}$
- Lead Formed for Surface Mount Applications in Plastic Sleeves (No Suffix)
- Straight Lead Version in Plastic Sleeves (“-1” Suffix)
- Lead Formed Version in 16 mm Tape and Reel (“T4” Suffix)
- Low Collector-Emitter Saturation Voltage —
 $V_{CE(sat)} = 0.3 \text{ Vdc (Max) @ } I_C = 500 \text{ mAdc}$
 $= 0.75 \text{ Vdc (Max) @ } I_C = 2.0 \text{ Adc}$
- High Current-Gain — Bandwidth Product —
 $f_T = 65 \text{ MHz (Min) @ } I_C = 100 \text{ mAdc}$
- Annular Construction for Low Leakage —
 $I_{CBO} = 100 \text{ nAdc @ Rated } V_{CB}$

MAXIMUM RATINGS

| Rating | Symbol | Value | Unit |
|--|----------------|--------------|------------------------------|
| Collector-Base Voltage | V_{CB} | 40 | Vdc |
| Collector-Emitter Voltage | V_{CEO} | 25 | Vdc |
| Emitter-Base Voltage | V_{EB} | 8 | Vdc |
| Collector Current — Continuous Peak | I_C | 5 10 | Adc |
| Base Current | I_B | 1 | Adc |
| Total Device Dissipation @ $T_C = 25^\circ\text{C}$ Derate above 25°C | P_D | 12.5 0.1 | Watts W/ $^\circ\text{C}$ |
| Total Device Dissipation @ $T_A = 25^\circ\text{C}^*$ Derate above 25°C | P_D | 1.4 0.011 | Watts W/ $^\circ\text{C}$ |
| Operating and Storage Junction Temperature Range | T_J, T_{stg} | -65 to +150 | $^\circ\text{C}$ |

**NPN
MJD200
PNP
MJD210**

**SILICON
POWER TRANSISTORS
5 AMPERES
25 VOLTS
12.5 WATTS**



CASE 369A-13

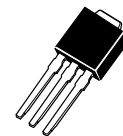

CASE 369-07

MINIMUM PAD SIZES RECOMMENDED FOR SURFACE MOUNTED APPLICATIONS

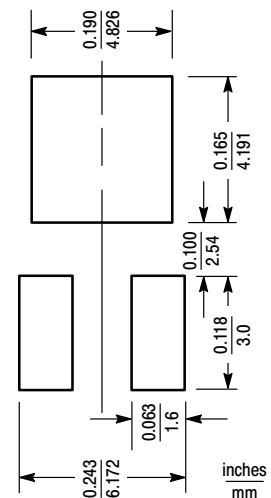

MJD200 MJD210

THERMAL CHARACTERISTICS

| Characteristic | Symbol | Max | Unit |
|--------------------------------------|-----------------|------|---------------|
| Thermal Resistance, Junction to Case | $R_{\theta JC}$ | 10 | $^{\circ}C/W$ |
| Junction to Ambient* | $R_{\theta JA}$ | 89.3 | |

ELECTRICAL CHARACTERISTICS ($T_C = 25^{\circ}C$ unless otherwise noted)

| Characteristic | Symbol | Min | Max | Unit |
|----------------|--------|-----|-----|------|
|----------------|--------|-----|-----|------|

OFF CHARACTERISTICS

| | | | | |
|---|---------------|----|-----|------|
| Collector–Emitter Sustaining Voltage (1) ($I_C = 10$ mAdc, $I_B = 0$) | $V_{CE(sus)}$ | 25 | — | Vdc |
| Collector Cutoff Current ($V_{CB} = 40$ Vdc, $I_E = 0$) ($V_{CB} = 40$ Vdc, $I_E = 0$, $T_J = 125^{\circ}C$) | I_{CBO} | — | 100 | nAdc |
| Emitter Cutoff Current ($V_{BE} = 8$ Vdc, $I_C = 0$) | I_{EBO} | — | 100 | nAdc |

ON CHARACTERISTICS

| | | | | |
|---|---------------|----------------|--------------------|-----|
| DC Current Gain (2) ($I_C = 500$ mAdc, $V_{CE} = 1$ Vdc) ($I_C = 2$ Adc, $V_{CE} = 1$ Vdc) ($I_C = 5$ Adc, $V_{CE} = 2$ Vdc) | h_{FE} | 70 45 10 | — 180 — | — |
| Collector–Emitter Saturation Voltage (2) ($I_C = 500$ mAdc, $I_B = 50$ mAdc) ($I_C = 2$ Adc, $I_B = 200$ mAdc) ($I_C = 5$ Adc, $I_B = 1$ Adc) | $V_{CE(sat)}$ | — — — | 0.3 0.75 1.8 | Vdc |
| Base–Emitter Saturation Voltage (1) ($I_C = 5$ Adc, $I_B = 1$ Adc) | $V_{BE(sat)}$ | — | 2.5 | Vdc |
| Base–Emitter On Voltage (1) ($I_C = 2$ Adc, $V_{CE} = 1$ Vdc) | $V_{BE(on)}$ | — | 1.6 | Vdc |

DYNAMIC CHARACTERISTICS

| | | | | |
|---|------------------------------|--------|-----------|-----|
| Current–Gain — Bandwidth Product (3) ($I_C = 100$ mAdc, $V_{CE} = 10$ Vdc, $f_{test} = 10$ MHz) | f_T | 65 | — | MHz |
| Output Capacitance ($V_{CB} = 10$ Vdc, $I_E = 0$, $f = 0.1$ MHz) | MJD200 MJD210 C_{ob} | — — | 80 120 | pF |

*When surface mounted on minimum pad sizes recommended.

(continued)

(1) Pulse Test: Pulse Width = 300 μs , Duty Cycle \approx 2%.

(2) Pulse Test: Pulse Width = 300 μs , Duty Cycle \approx 2%.

(3) $f_T = |h_{fe}| \cdot f_{test}$.

MJD200 MJD210

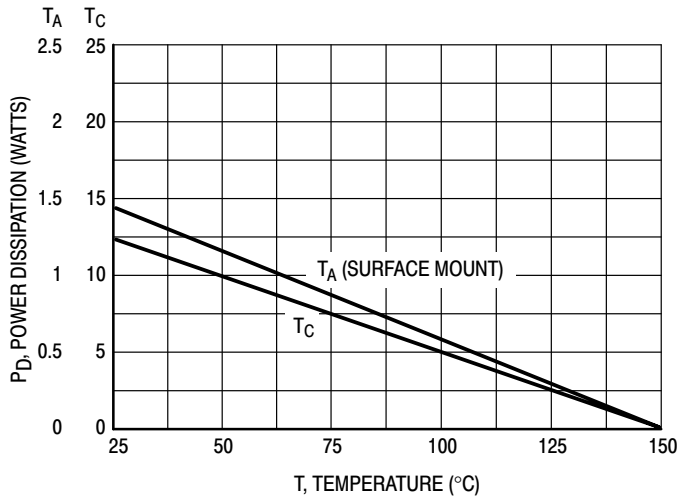

Figure 1. Power Derating

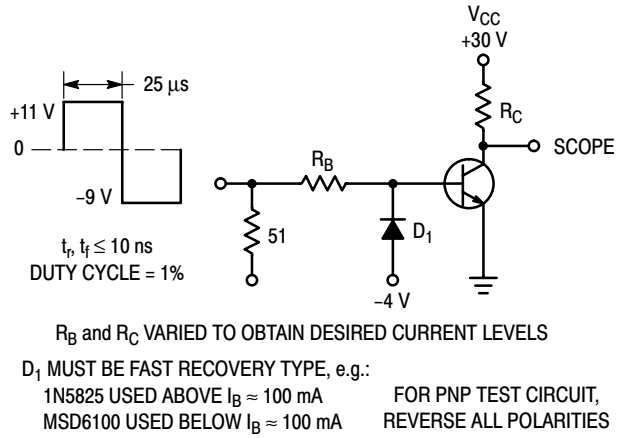

Figure 2. Switching Time Test Circuit

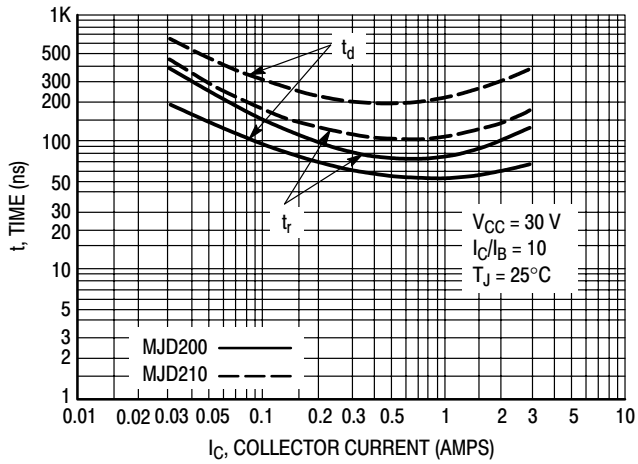

Figure 3. Turn-On Time

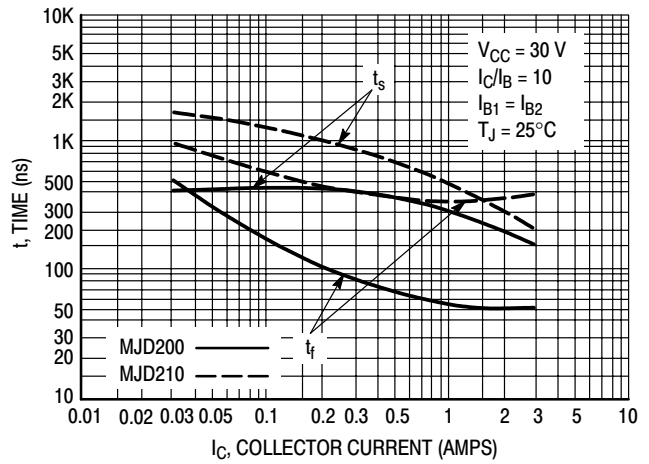
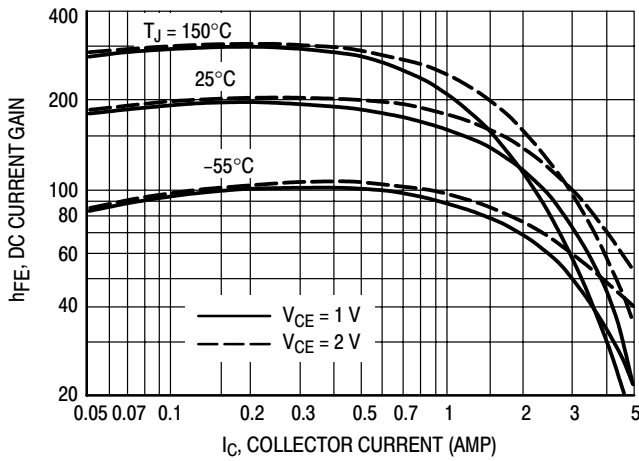

Figure 4. Turn-Off Time

MJD200 MJD210

**NPN
MJD200**



**PNP
MJD210**

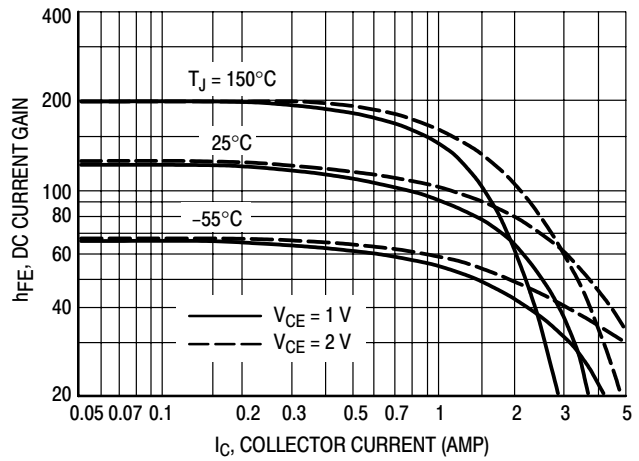

Figure 5. DC Current Gain

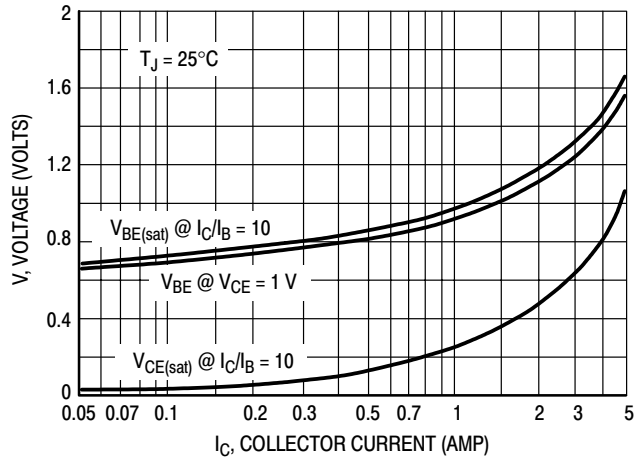
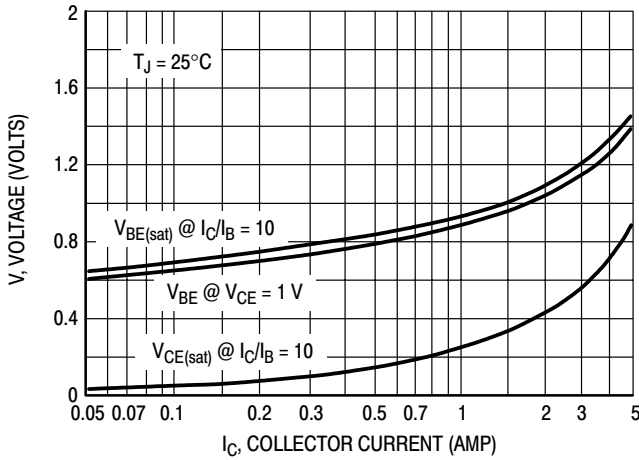

Figure 6. "On" Voltage

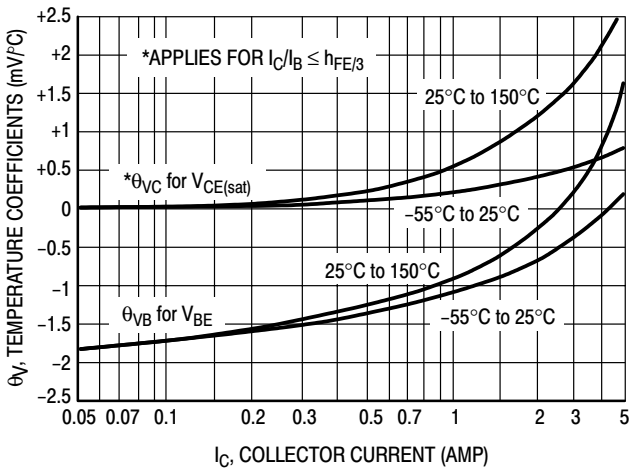
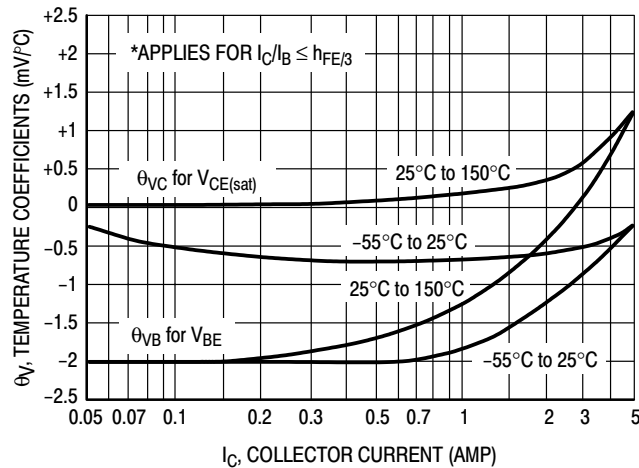

Figure 7. Temperature Coefficients

MJD200 MJD210

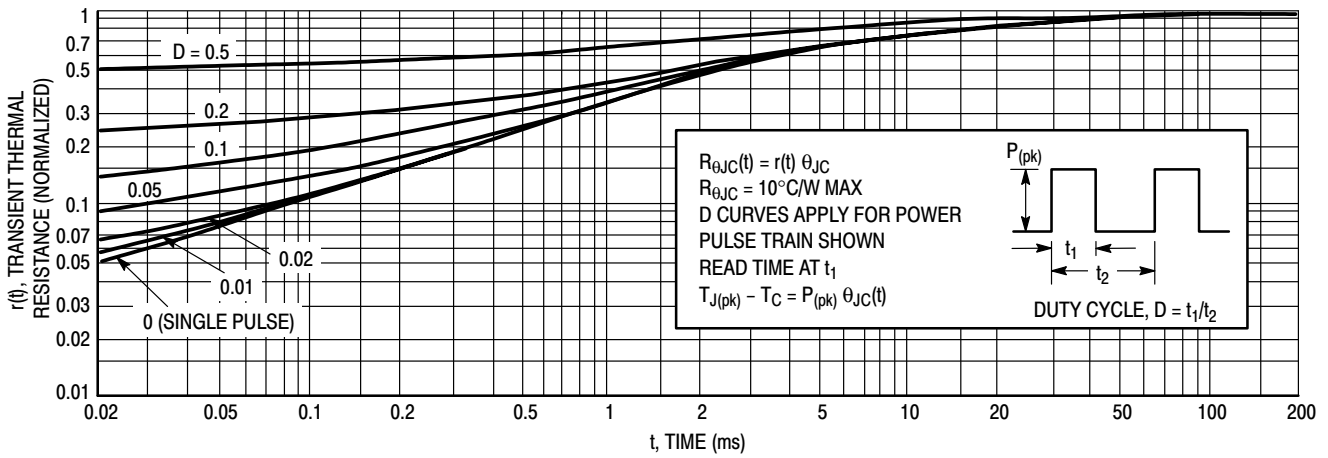

Figure 8. Thermal Response

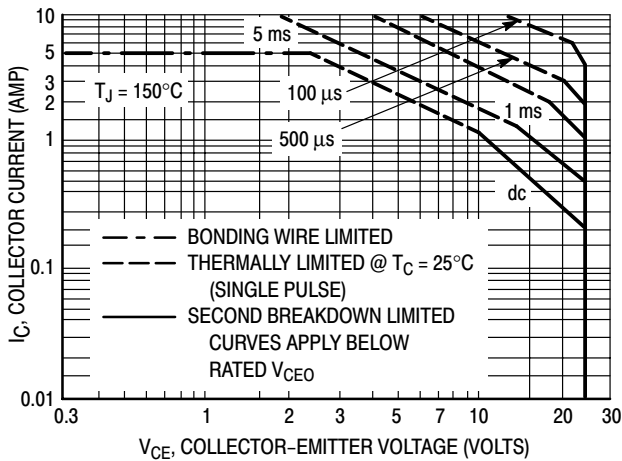

Figure 9. Active Region Safe Operating Area

There are two limitations on the power handling ability of a transistor: average junction temperature and second breakdown. Safe operating area curves indicate $I_C - V_{CE}$ limits of the transistor that must be observed for reliable operation; i.e., the transistor must not be subjected to greater dissipation than the curves indicate.

The data of Figure 9 is based on $T_{J(pk)} = 150^{\circ}\text{C}$; T_C is variable depending on conditions. Second breakdown pulse limits are valid for duty cycles to 10% provided $T_{J(pk)} \leq 150^{\circ}\text{C}$. $T_{J(pk)}$ may be calculated from the data in Figure 8. At high case temperatures, thermal limitations will reduce the power that can be handled to values less than the limitations imposed by second breakdown.

Case 369 may be ordered by adding a “-1” suffix to the device title (i.e. MJD200-1)

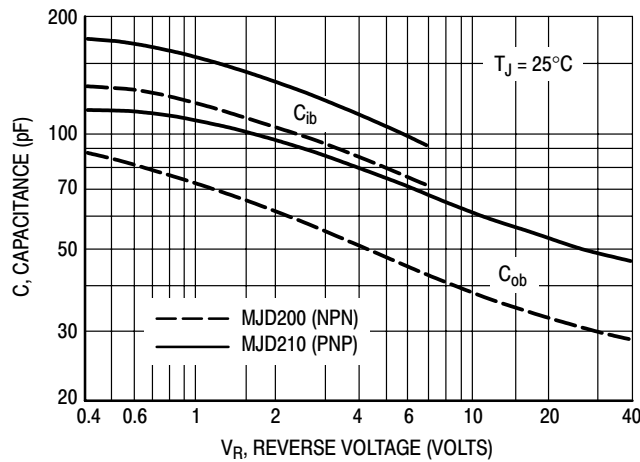
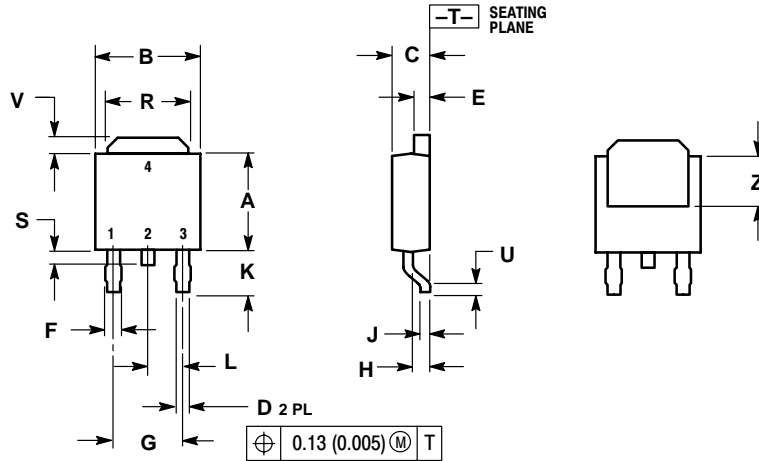

Figure 10. Capacitance

MJD200 MJD210

PACKAGE DIMENSIONS

DPAK CASE 369A-13 ISSUE AA



NOTES:

1. DIMENSIONING AND TOLERANCING PER ANSI Y14.5M, 1982.
2. CONTROLLING DIMENSION: INCH.

| DIM | INCHES | | MILLIMETERS | |
|-----|-----------|-------|-------------|------|
| | MIN | MAX | MIN | MAX |
| A | 0.235 | 0.250 | 5.97 | 6.35 |
| B | 0.250 | 0.265 | 6.35 | 6.73 |
| C | 0.086 | 0.094 | 2.19 | 2.38 |
| D | 0.027 | 0.035 | 0.69 | 0.88 |
| E | 0.033 | 0.040 | 0.84 | 1.01 |
| F | 0.037 | 0.047 | 0.94 | 1.19 |
| G | 0.180 BSC | | 4.58 BSC | |
| H | 0.034 | 0.040 | 0.87 | 1.01 |
| J | 0.018 | 0.023 | 0.46 | 0.58 |
| K | 0.102 | 0.114 | 2.60 | 2.89 |
| L | 0.090 BSC | | 2.29 BSC | |
| R | 0.175 | 0.215 | 4.45 | 5.46 |
| S | 0.020 | 0.050 | 0.51 | 1.27 |
| U | 0.020 | --- | 0.51 | --- |
| V | 0.030 | 0.050 | 0.77 | 1.27 |
| Z | 0.138 | --- | 3.51 | --- |

MJD200 MJD210

PACKAGE DIMENSIONS

DPAK CASE 369-07 ISSUE M

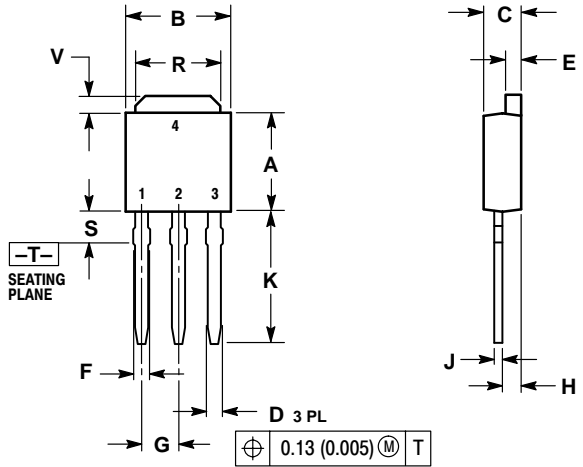

- NOTES:
 1. DIMENSIONING AND TOLERANCING PER ANSI Y14.5M, 1982.
 2. CONTROLLING DIMENSION: INCH.

| DIM | INCHES | | MILLIMETERS | |
|-----|-----------|-------|-------------|------|
| | MIN | MAX | MIN | MAX |
| A | 0.235 | 0.250 | 5.97 | 6.35 |
| B | 0.250 | 0.265 | 6.35 | 6.73 |
| C | 0.086 | 0.094 | 2.19 | 2.38 |
| D | 0.027 | 0.035 | 0.69 | 0.88 |
| E | 0.033 | 0.040 | 0.84 | 1.01 |
| F | 0.037 | 0.047 | 0.94 | 1.19 |
| G | 0.090 BSC | | 2.29 BSC | |
| H | 0.034 | 0.040 | 0.87 | 1.01 |
| J | 0.018 | 0.023 | 0.46 | 0.58 |
| K | 0.350 | 0.380 | 8.89 | 9.65 |
| R | 0.175 | 0.215 | 4.45 | 5.46 |
| S | 0.050 | 0.090 | 1.27 | 2.28 |
| V | 0.030 | 0.050 | 0.77 | 1.27 |

ON Semiconductor and  are trademarks of Semiconductor Components Industries, LLC (SCILLC). SCILLC reserves the right to make changes without further notice to any products herein. SCILLC makes no warranty, representation or guarantee regarding the suitability of its products for any particular purpose, nor does SCILLC assume any liability arising out of the application or use of any product or circuit, and specifically disclaims any and all liability, including without limitation special, consequential or incidental damages. "Typical" parameters which may be provided in SCILLC data sheets and/or specifications can and do vary in different applications and actual performance may vary over time. All operating parameters, including "Typicals" must be validated for each customer application by customer's technical experts. SCILLC does not convey any license under its patent rights nor the rights of others. SCILLC products are not designed, intended, or authorized for use as components in systems intended for surgical implant into the body, or other applications intended to support or sustain life, or for any other application in which the failure of the SCILLC product could create a situation where personal injury or death may occur. Should Buyer purchase or use SCILLC products for any such unintended or unauthorized application, Buyer shall indemnify and hold SCILLC and its officers, employees, subsidiaries, affiliates, and distributors harmless against all claims, costs, damages, and expenses, and reasonable attorney fees arising out of, directly or indirectly, any claim of personal injury or death associated with such unintended or unauthorized use, even if such claim alleges that SCILLC was negligent regarding the design or manufacture of the part. SCILLC is an Equal Opportunity/Affirmative Action Employer.

PUBLICATION ORDERING INFORMATION

Literature Fulfillment:

Literature Distribution Center for ON Semiconductor
P.O. Box 5163, Denver, Colorado 80217 USA
Phone: 303-675-2175 or 800-344-3860 Toll Free USA/Canada
Fax: 303-675-2176 or 800-344-3867 Toll Free USA/Canada
Email: ONlit@hibbertco.com

N. American Technical Support: 800-282-9855 Toll Free USA/Canada

JAPAN: ON Semiconductor, Japan Customer Focus Center
4-32-1 Nishi-Gotanda, Shinagawa-ku, Tokyo, Japan 141-0031
Phone: 81-3-5740-2700
Email: r14525@onsemi.com

ON Semiconductor Website: <http://onsemi.com>

For additional information, please contact your local Sales Representative.