

# Complementary Darlington Power Transistors

## DPAK For Surface Mount Applications

Designed for general purpose power and switching such as output or driver stages in applications such as switching regulators, converters, and power amplifiers.

- Lead Formed for Surface Mount Applications in Plastic Sleeves (No Suffix)
- Straight Lead Version in Plastic Sleeves (“1” Suffix)
- Lead Formed Version in 16 mm Tape and Reel (“T4” Suffix)
- Surface Mount Replacements for TIP110–TIP117 Series
- Monolithic Construction With Built-in Base–Emitter Shunt Resistors
- High DC Current Gain —  
 $h_{FE} = 2500$  (Typ) @  $I_C = 2.0$  Adc
- Complementary Pairs Simplifies Designs

### MAXIMUM RATINGS

Rating	Symbol	MJD112 MJD117	Unit
Collector–Emitter Voltage	$V_{CEO}$	100	Vdc
Collector–Base Voltage	$V_{CB}$	100	Vdc
Emitter–Base Voltage	$V_{EB}$	5	Vdc
Collector Current — Continuous Peak	$I_C$	2 4	Adc
Base Current	$I_B$	50	mAdc
Total Power Dissipation @ $T_C = 25^\circ\text{C}$ Derate above $25^\circ\text{C}$	$P_D$	20 0.16	Watts W/ $^\circ\text{C}$
Total Power Dissipation* @ $T_A = 25^\circ\text{C}$ Derate above $25^\circ\text{C}$	$P_D$	1.75 0.014	Watts W/ $^\circ\text{C}$
Operating and Storage Junction Temperature Range	$T_J, T_{stg}$	-65 to +150	$^\circ\text{C}$

**NPN  
MJD112\***  
**PNP  
MJD117\***

\*ON Semiconductor Preferred Device

**SILICON  
POWER TRANSISTORS  
2 AMPERES  
100 VOLTS  
20 WATTS**



CASE 369A-13

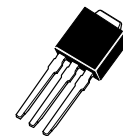

CASE 369-07

### MINIMUM PAD SIZES RECOMMENDED FOR SURFACE MOUNTED APPLICATIONS

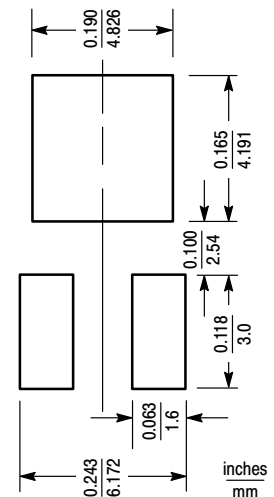

Preferred devices are ON Semiconductor recommended choices for future use and best overall value.

# MJD112 MJD117

## THERMAL CHARACTERISTICS

Characteristic	Symbol	Max	Unit
Thermal Resistance, Junction to Case	$R_{\theta JC}$	6.25	$^{\circ}C/W$
Thermal Resistance, Junction to Ambient*	$R_{\theta JA}$	71.4	$^{\circ}C/W$

## ELECTRICAL CHARACTERISTICS ( $T_C = 25^{\circ}C$ unless otherwise noted)

Characteristic	Symbol	Min	Max	Unit
----------------	--------	-----	-----	------

### OFF CHARACTERISTICS

Collector-Emitter Sustaining Voltage (1) ( $I_C = 30$ mAdc, $I_B = 0$ )	$V_{CE(sus)}$	100	—	Vdc
Collector Cutoff Current ( $V_{CE} = 50$ Vdc, $I_B = 0$ )	$I_{CEO}$	—	20	$\mu$ Adc
Collector Cutoff Current ( $V_{CB} = 100$ Vdc, $I_E = 0$ )	$I_{CBO}$	—	20	$\mu$ Adc
Emitter Cutoff Current ( $V_{BE} = 5$ Vdc, $I_C = 0$ )	$I_{EBO}$	—	2	mAdc
Collector-Cutoff Current ( $V_{CB} = 80$ Vdc, $I_E = 0$ )	$I_{CBO}$	—	10	$\mu$ Adc
Emitter-Cutoff Current ( $V_{BE} = 5$ Vdc, $I_C = 0$ )	$I_{EBO}$	—	2	mAdc

### ON CHARACTERISTICS

DC Current Gain ( $I_C = 0.5$ Adc, $V_{CE} = 3$ Vdc) ( $I_C = 2$ Adc, $V_{CE} = 3$ Vdc) ( $I_C = 4$ Adc, $V_{CE} = 3$ Vdc)	$h_{FE}$	500 1000 200	— 12,000 —	—
Collector-Emitter Saturation Voltage ( $I_C = 2$ Adc, $I_B = 8$ mAdc) ( $I_C = 4$ Adc, $I_B = 40$ mAdc)	$V_{CE(sat)}$	— —	2 3	Vdc
Base-Emitter Saturation Voltage ( $I_C = 4$ Adc, $I_B = 40$ mAdc)	$V_{BE(sat)}$	—	4	Vdc
Base-Emitter On Voltage ( $I_C = 2$ Adc, $V_{CE} = 3$ Vdc)	$V_{BE(on)}$	—	2.8	Vdc

### DYNAMIC CHARACTERISTICS

Current-Gain — Bandwidth Product ( $I_C = 0.75$ Adc, $V_{CE} = 10$ Vdc, $f = 1$ MHz)	$f_T$	25	—	MHz
Output Capacitance ( $V_{CB} = 10$ Vdc, $I_E = 0$ , $f = 0.1$ MHz)	$C_{ob}$	— —	200 100	pF
	MJD117			
	MJD112			

(1) Pulse Test: Pulse Width  $\leq 300$   $\mu$ s, Duty Cycle  $\leq 2\%$ .

\*These ratings are applicable when surface mounted on the minimum pad sizes recommended.

# MJD112 MJD117

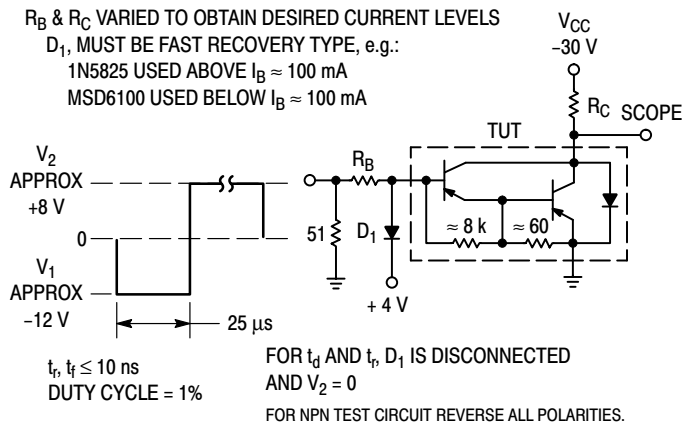

Figure 1. Switching Times Test Circuit

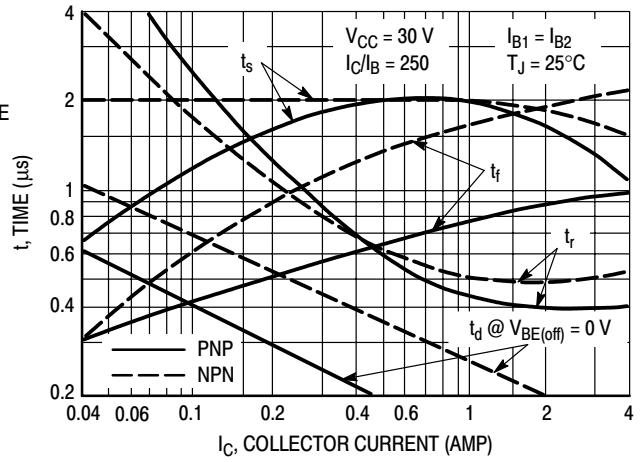

Figure 2. Switching Times

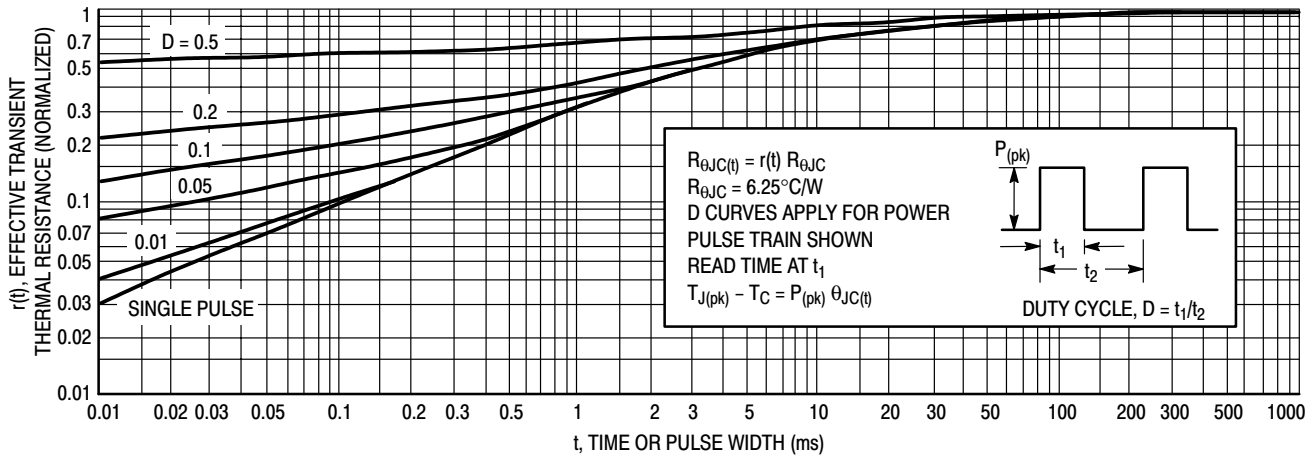

Figure 3. Thermal Response

ACTIVE-REGION SAFE-OPERATING AREA

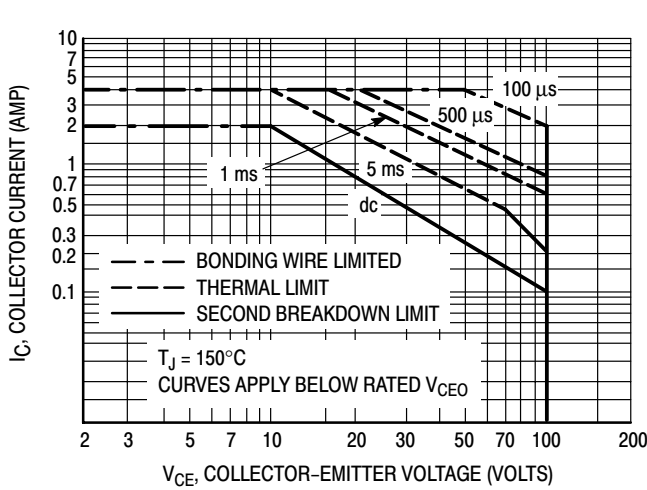

Figure 4. Maximum Rated Forward Biased Safe Operating Area

There are two limitations on the power handling ability of a transistor: average junction temperature and second breakdown. Safe operating area curves indicate  $I_C - V_{CE}$  limits of the transistor that must be observed for reliable operation; i.e., the transistor must not be subjected to greater dissipation than the curves indicate.

The data of Figures 5 and 6 is based on  $T_{J(pk)} = 150^\circ\text{C}$ ;  $T_C$  is variable depending on conditions. Second breakdown pulse limits are valid for duty cycles to 10% provided  $T_{J(pk)} < 150^\circ\text{C}$ .  $T_{J(pk)}$  may be calculated from the data in Figure 4. At high case temperatures, thermal limitations will reduce the power that can be handled to values less than the limitations imposed by second breakdown.

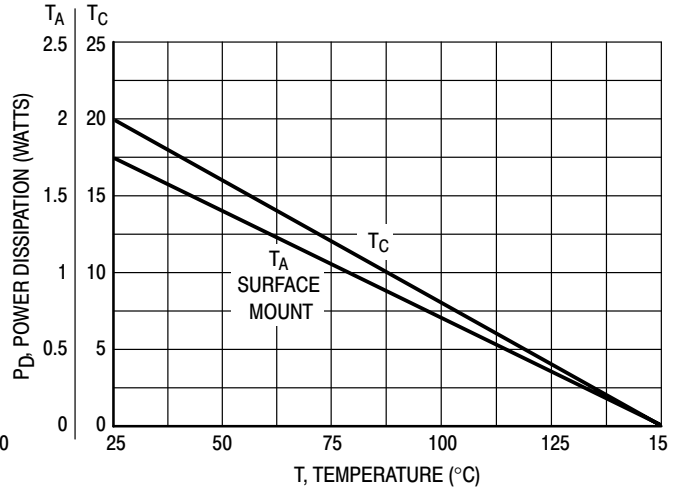

Figure 5. Power Derating

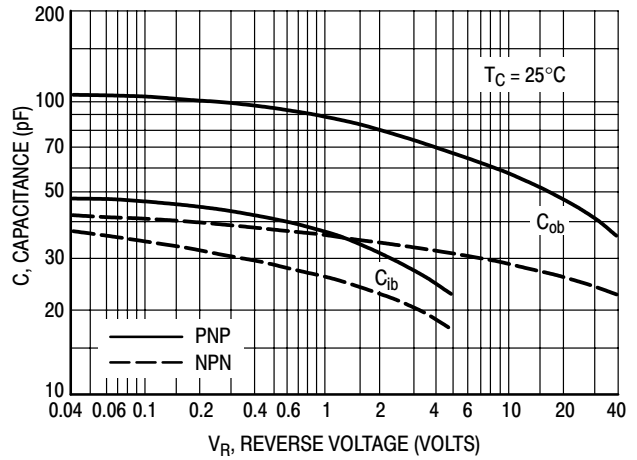
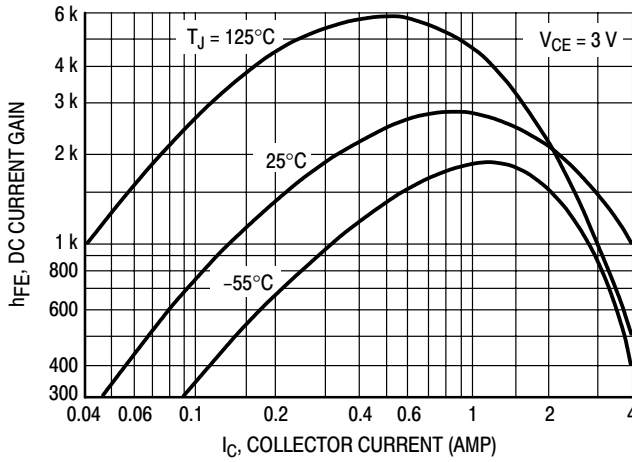

Figure 6. Capacitance

# MJD112 MJD117

## TYPICAL ELECTRICAL CHARACTERISTICS

**NPN MJD112**



**PNP MJD117**

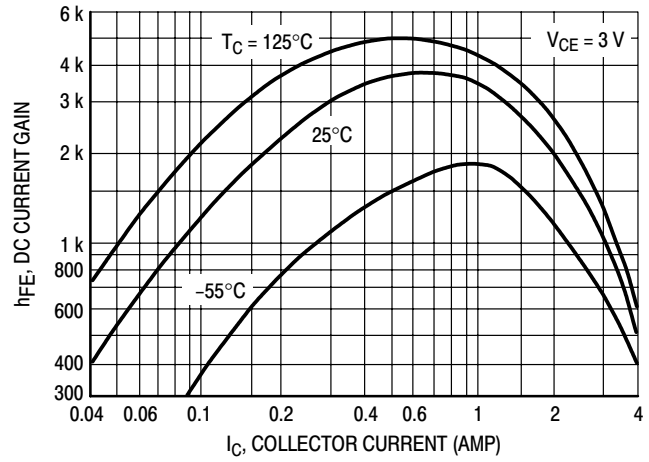

**Figure 7. DC Current Gain**

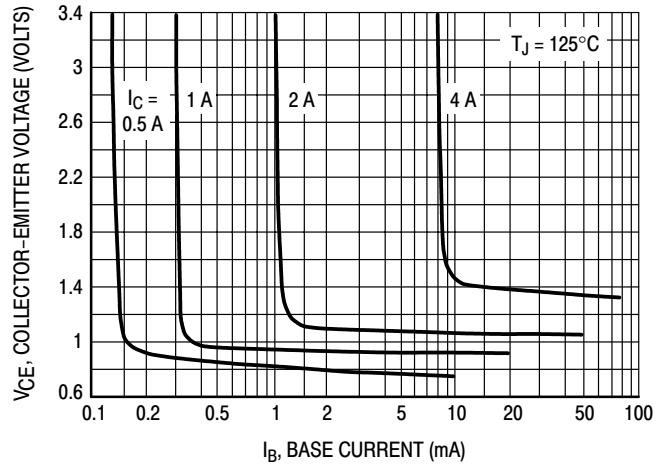
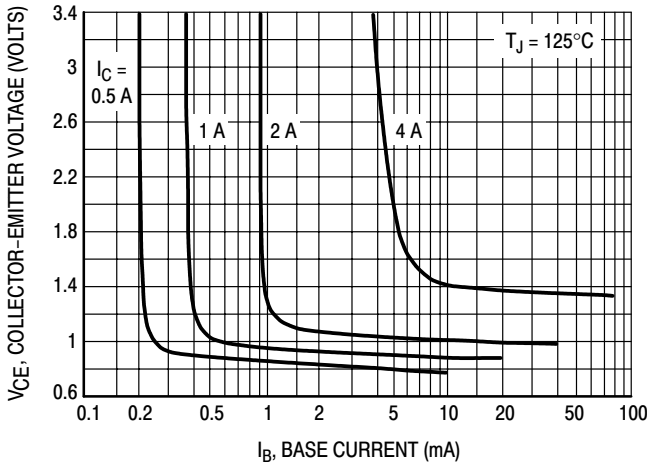

**Figure 8. Collector Saturation Region**

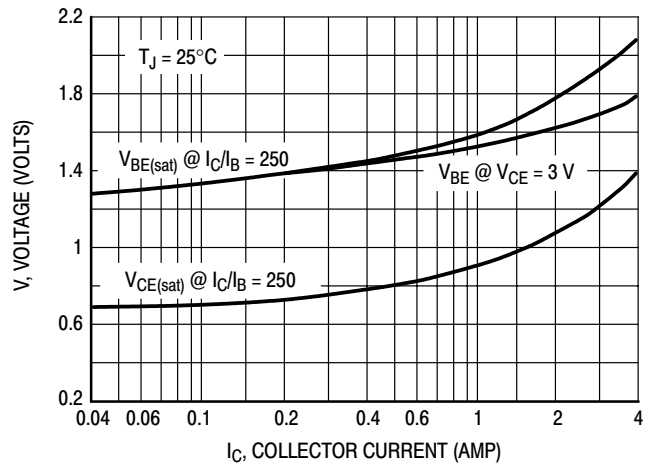
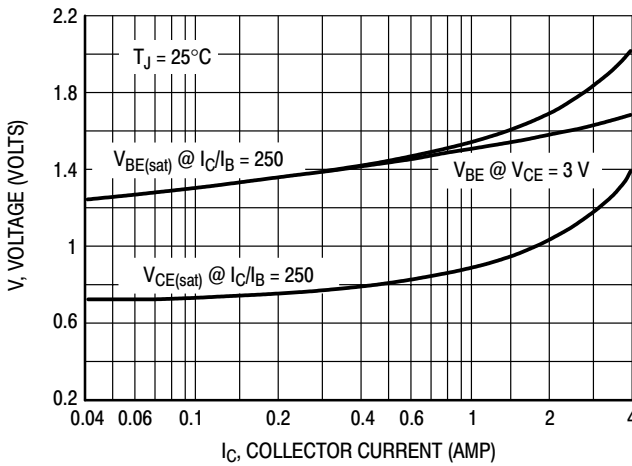

**Figure 9. "On Voltages"**

NPN MJD112

PNP MJD117

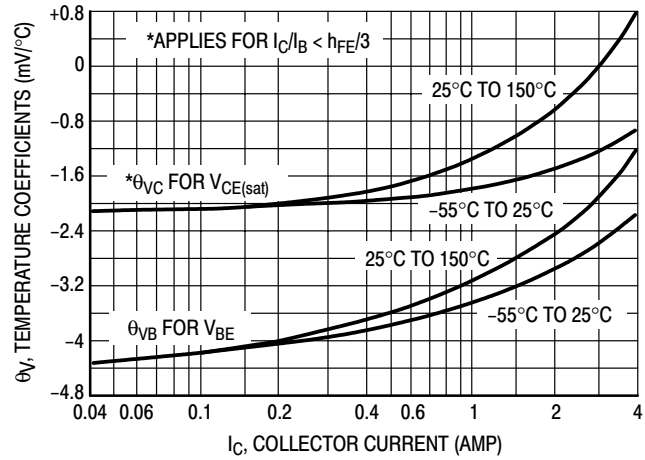
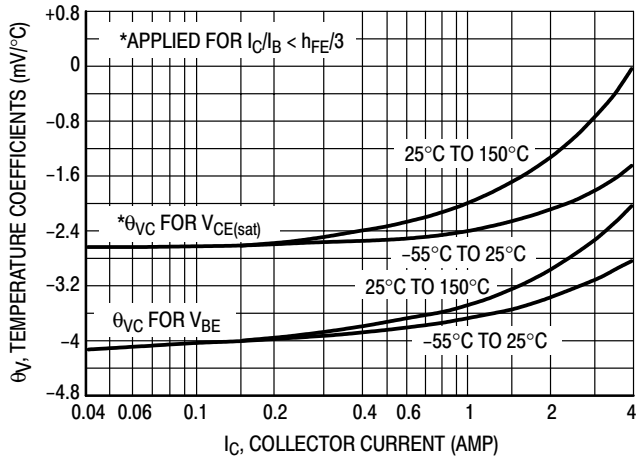

Figure 10. Temperature Coefficients

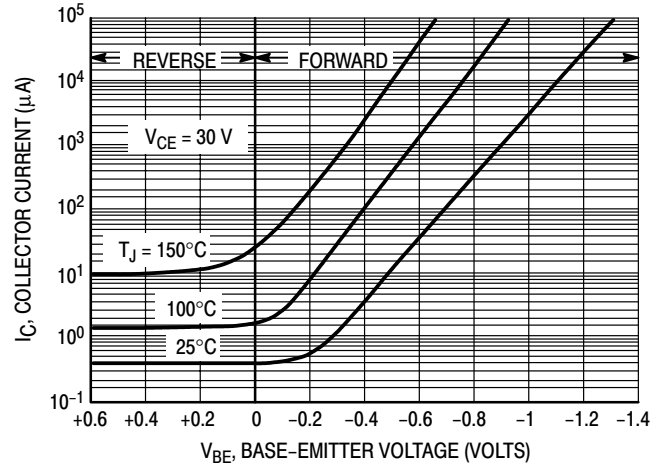
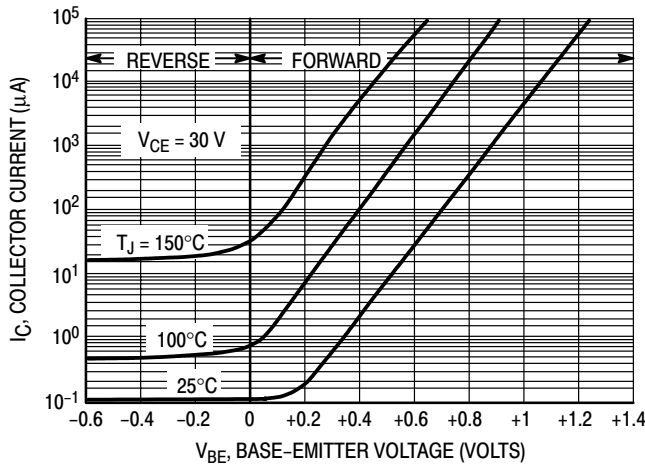

Figure 11. Collector Cut-Off Region

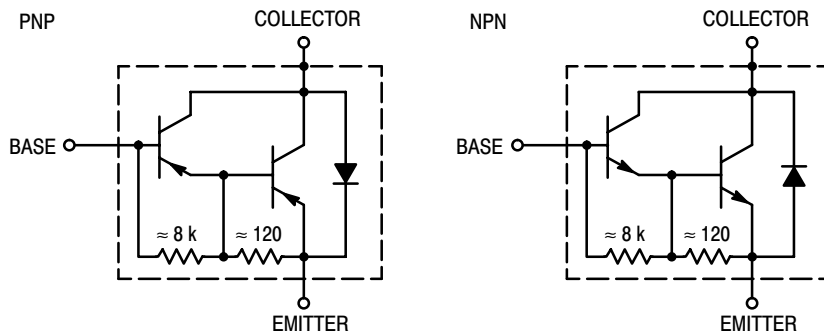
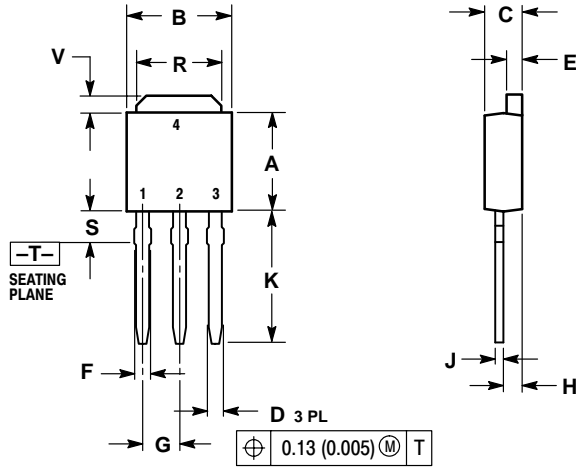

Figure 12. Darlington Schematic

# MJD112 MJD117

## PACKAGE DIMENSIONS

### DPAK CASE 369-07 ISSUE M



- NOTES:  
 1. DIMENSIONING AND TOLERANCING PER ANSI Y14.5M, 1982.  
 2. CONTROLLING DIMENSION: INCH.

DIM	INCHES		MILLIMETERS	
	MIN	MAX	MIN	MAX
A	0.235	0.250	5.97	6.35
B	0.250	0.265	6.35	6.73
C	0.086	0.094	2.19	2.38
D	0.027	0.035	0.69	0.88
E	0.033	0.040	0.84	1.01
F	0.037	0.047	0.94	1.19
G	0.090 BSC		2.29 BSC	
H	0.034	0.040	0.87	1.01
J	0.018	0.023	0.46	0.58
K	0.350	0.380	8.89	9.65
R	0.175	0.215	4.45	5.46
S	0.050	0.090	1.27	2.28
V	0.030	0.050	0.77	1.27

# MJD112 MJD117

## PACKAGE DIMENSIONS

### DPAK CASE 369A-13 ISSUE AA

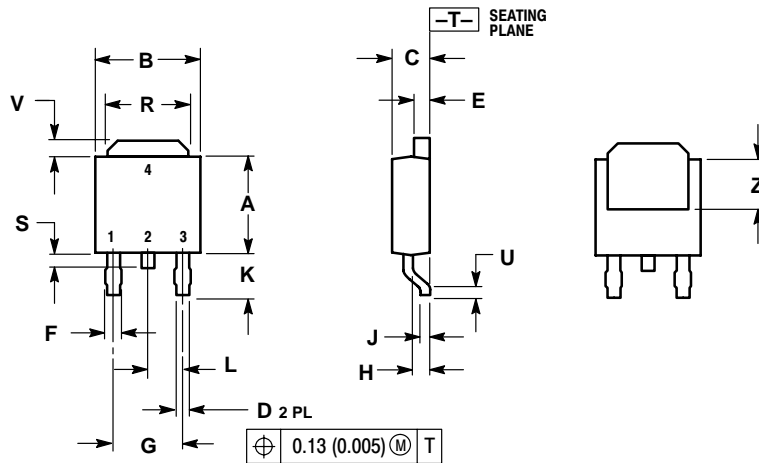

NOTES:

1. DIMENSIONING AND TOLERANCING PER ANSI Y14.5M, 1982.
2. CONTROLLING DIMENSION: INCH.

DIM	INCHES		MILLIMETERS	
	MIN	MAX	MIN	MAX
A	0.235	0.250	5.97	6.35
B	0.250	0.265	6.35	6.73
C	0.086	0.094	2.19	2.38
D	0.027	0.035	0.69	0.88
E	0.033	0.040	0.84	1.01
F	0.037	0.047	0.94	1.19
G	0.180 BSC		4.58 BSC	
H	0.034	0.040	0.87	1.01
J	0.018	0.023	0.46	0.58
K	0.102	0.114	2.60	2.89
L	0.090 BSC		2.29 BSC	
R	0.175	0.215	4.45	5.46
S	0.020	0.050	0.51	1.27
U	0.020	---	0.51	---
V	0.030	0.050	0.77	1.27
Z	0.138	---	3.51	---

**ON Semiconductor** and  are trademarks of Semiconductor Components Industries, LLC (SCILLC). SCILLC reserves the right to make changes without further notice to any products herein. SCILLC makes no warranty, representation or guarantee regarding the suitability of its products for any particular purpose, nor does SCILLC assume any liability arising out of the application or use of any product or circuit, and specifically disclaims any and all liability, including without limitation special, consequential or incidental damages. "Typical" parameters which may be provided in SCILLC data sheets and/or specifications can and do vary in different applications and actual performance may vary over time. All operating parameters, including "Typicals" must be validated for each customer application by customer's technical experts. SCILLC does not convey any license under its patent rights nor the rights of others. SCILLC products are not designed, intended, or authorized for use as components in systems intended for surgical implant into the body, or other applications intended to support or sustain life, or for any other application in which the failure of the SCILLC product could create a situation where personal injury or death may occur. Should Buyer purchase or use SCILLC products for any such unintended or unauthorized application, Buyer shall indemnify and hold SCILLC and its officers, employees, subsidiaries, affiliates, and distributors harmless against all claims, costs, damages, and expenses, and reasonable attorney fees arising out of, directly or indirectly, any claim of personal injury or death associated with such unintended or unauthorized use, even if such claim alleges that SCILLC was negligent regarding the design or manufacture of the part. SCILLC is an Equal Opportunity/Affirmative Action Employer.

### PUBLICATION ORDERING INFORMATION

**Literature Fulfillment:**

Literature Distribution Center for ON Semiconductor  
P.O. Box 5163, Denver, Colorado 80217 USA  
**Phone:** 303-675-2175 or 800-344-3860 Toll Free USA/Canada  
**Fax:** 303-675-2176 or 800-344-3867 Toll Free USA/Canada  
**Email:** ONlit@hibbertco.com

**N. American Technical Support:** 800-282-9855 Toll Free USA/Canada

**JAPAN:** ON Semiconductor, Japan Customer Focus Center  
4-32-1 Nishi-Gotanda, Shinagawa-ku, Tokyo, Japan 141-0031  
**Phone:** 81-3-5740-2700  
**Email:** r14525@onsemi.com

**ON Semiconductor Website:** <http://onsemi.com>

For additional information, please contact your local Sales Representative.