

Silicon NPN Power Transistors

2SD959

DESCRIPTION

- With TO-220 package
- Low collector saturation voltage
- Complement to type 2SB867
- Excellent linearity of h_{FE}

APPLICATIONS

- For power switching applications

PINNING

PIN	DESCRIPTION
1	Base
2	Collector;connected to mounting base
3	Emitter

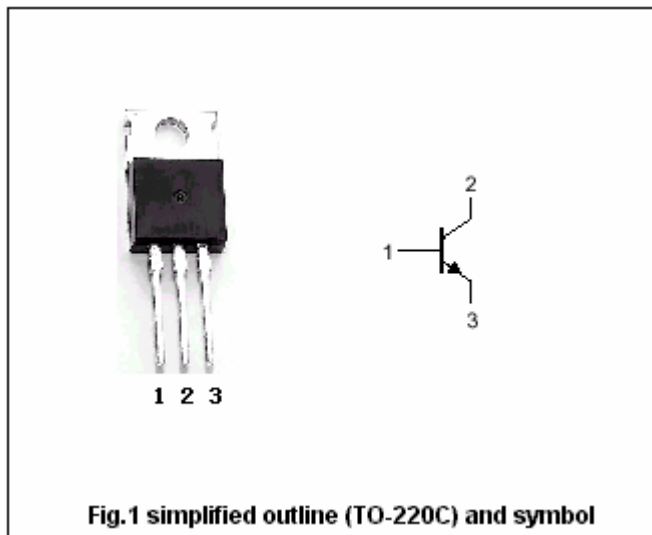

Absolute maximum ratings (Ta=25°C)

SYMBOL	PARAMETER	CONDITIONS	VALUE	UNIT
V_{CBO}	Collector-base voltage	Open emitter	130	V
V_{CEO}	Collector-emitter voltage	Open base	80	V
V_{EBO}	Emitter-base voltage	Open collector	7	V
I_C	Collector current (DC)		3	A
I_{CM}	Collector current-peak		6	A
P_C	Collector power dissipation	$T_C=25^\circ C$	30	W
T_j	Junction temperature		150	°C
T_{stg}	Storage temperature		-55~150	°C

Silicon NPN Power Transistors

2SD959

CHARACTERISTICS

T_j=25°C unless otherwise specified

SYMBOL	PARAMETER	CONDITIONS	MIN	TYP.	MAX	UNIT
V _{(BR)CEO}	Collector-emitter breakdown voltage	I _C =10mA ; I _E =0	80			V
V _{CEsat}	Collector-emitter saturation voltage	I _C =2A; I _B =0.1A			0.5	V
V _{BEsat}	Base-emitter saturation voltage	I _C =2A; I _B =0.1A			1.5	V
I _{CBO}	Collector cut-off current	V _{CB} =100V; I _E =0			10	μA
I _{EBO}	Emitter cut-off current	V _{EB} =5V; I _C =0			50	μA
h _{FE-1}	DC current gain	I _C =0.1A ; V _{CE} =2V	45			
h _{FE-2}	DC current gain	I _C =0.5A ; V _{CE} =2V	60		260	
f _T	Transition frequency	I _C =0.5A ; V _{CE} =10V		30		MHz

Switching times

t _{on}	Turn-on time	I _C =0.5A I _{B1} =-I _{B2} =50mA		0.5		μs
t _s	Storage time			2.5		μs
t _f	Fall time			0.15		μs

◆ h_{FE-2} classifications

R	Q	P
60-120	90-180	130-260

Silicon NPN Power Transistors

2SD959

PACKAGE OUTLINE

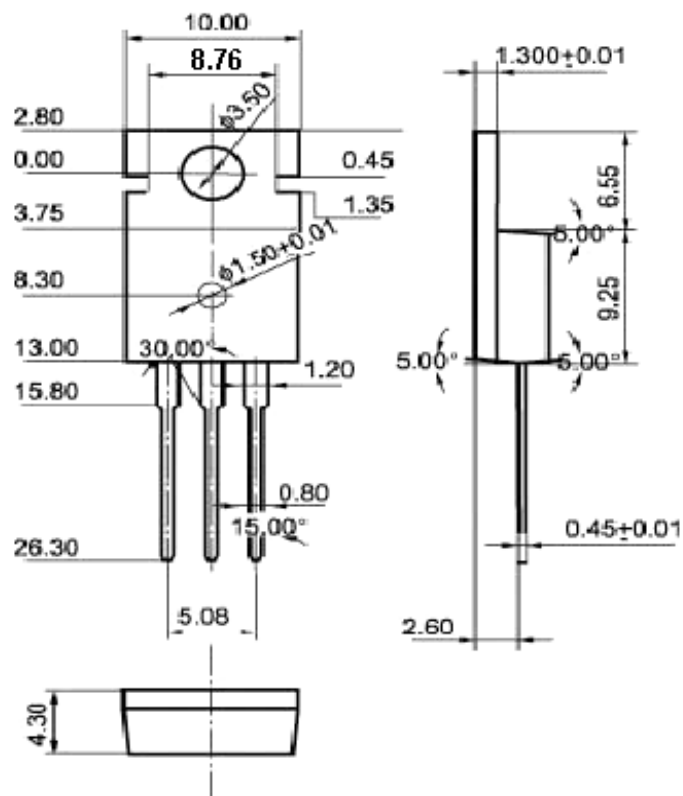
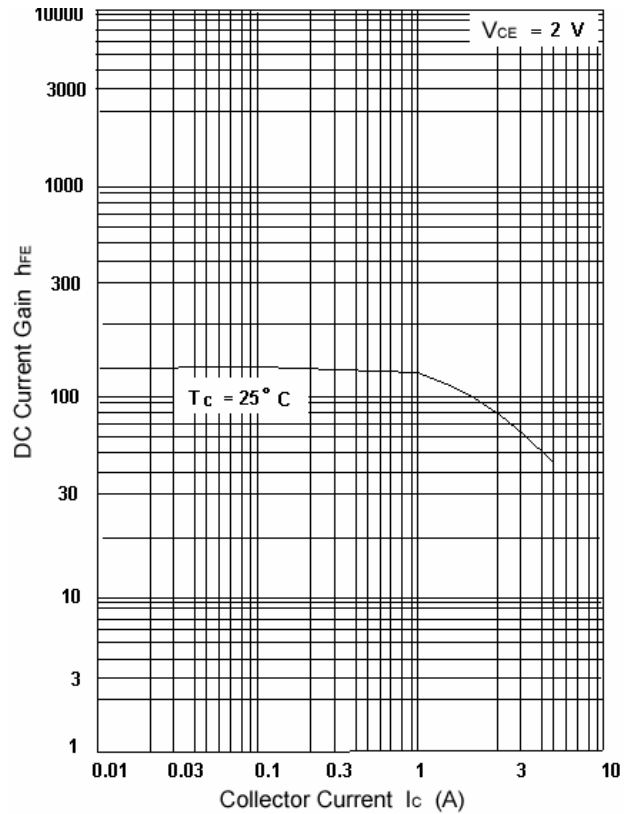
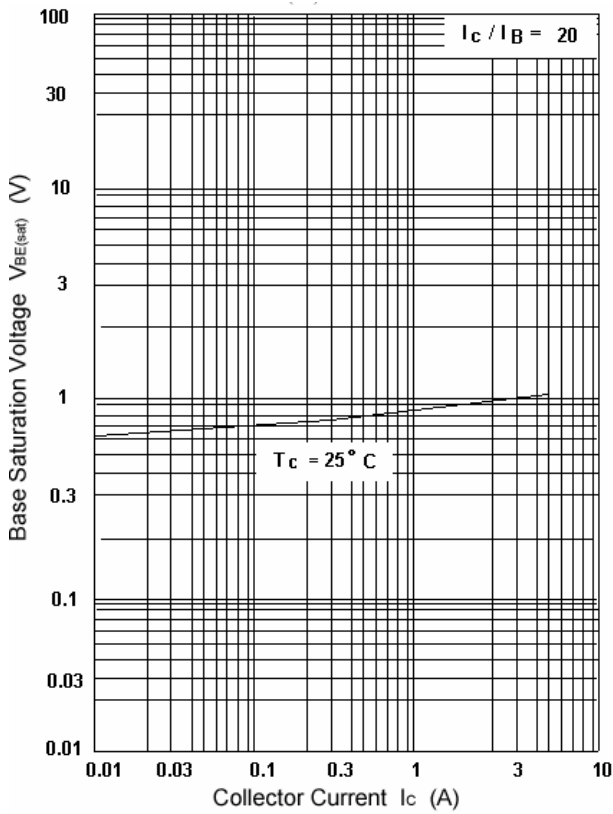
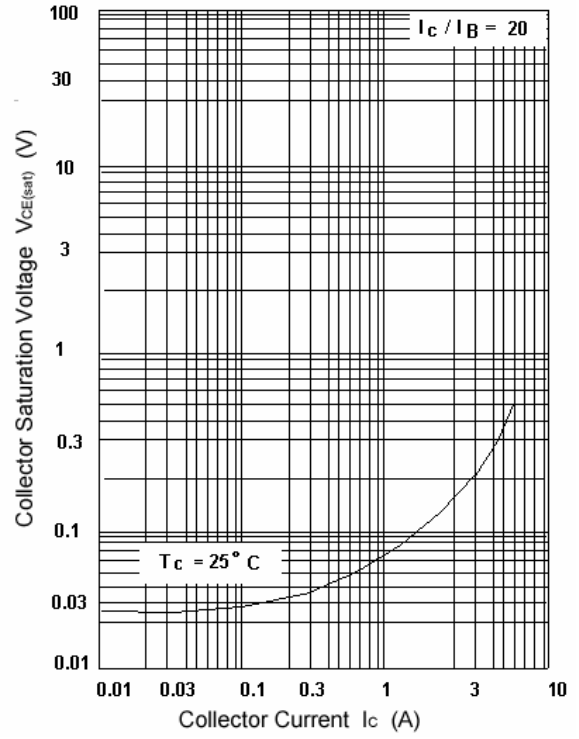
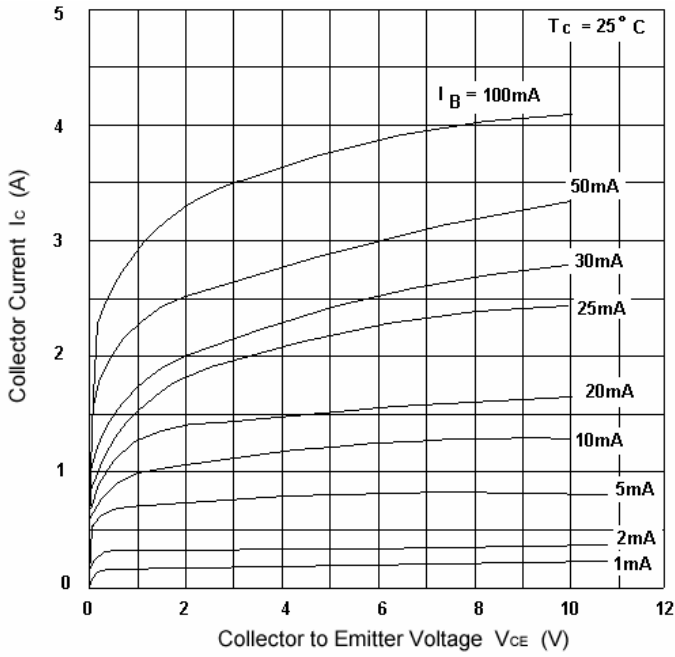

Fig.2 outline dimensions (unindicated tolerance:±0.10 mm)

Silicon NPN Power Transistors

2SD959



Silicon NPN Power Transistors

2SD959

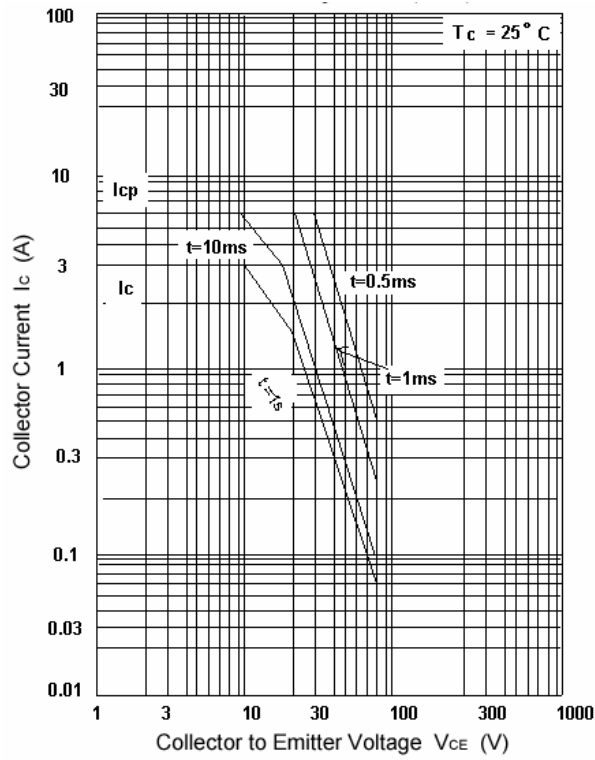

Fig.7 Safe Operating Area