



The Future of Analog IC Technology™

# MP2105

## 1MHz, 800mA Synchronous Step-Down Converter

### DESCRIPTION

The MP2105 is a 1MHz constant frequency, current mode, PWM step-down converter. The device integrates a main switch and a synchronous rectifier for high efficiency without an external Schottky diode. It is ideal for powering portable equipment that runs from a single cell Lithium-Ion (Li+) battery. The MP2105 can supply 800mA of load current from a 2.5V to 6V input voltage. The output voltage can be regulated as low as 0.6V. The MP2105 can also run at 100% duty cycle for low dropout applications.

The MP2105 is available in a low profile (1mm) 5-pin, TSOT package.

### EVALUATION BOARD REFERENCE

| Board Number | Dimensions            |
|--------------|-----------------------|
| EV2105DJ-00A | 2.0"X x 2.0"Y x 0.5"Z |

### FEATURES

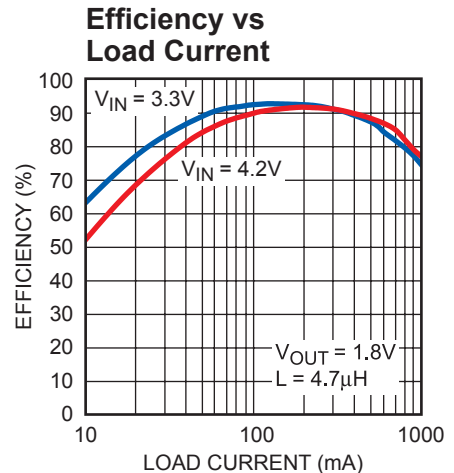
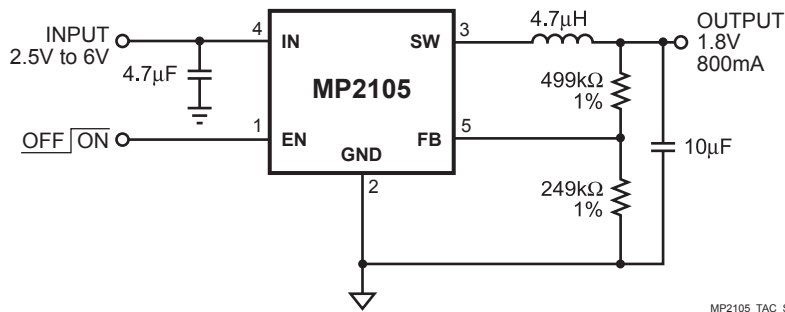
- High Efficiency: Up to 95%
- 1MHz Constant Switching Frequency
- 800mA Available Load Current
- 2.5V to 6V Input Voltage Range
- Output Voltage as Low as 0.6V
- 100% Duty Cycle in Dropout
- Current Mode Control
- Short Circuit Protection
- Thermal Fault Protection
- <0.1µA Shutdown Current
- Space Saving 5-Pin TSOT23 Package

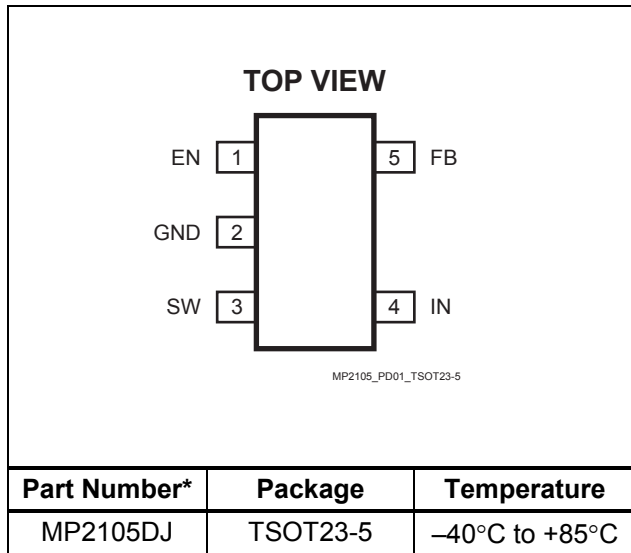
### APPLICATIONS

- Cellular and Smart Phones
- Microprocessors and DSP Core Supplies
- PDAs
- MP3 Players
- Digital Still and Video Cameras
- Portable Instruments

"MPS" and "The Future of Analog IC Technology" are Trademarks of Monolithic Power Systems, Inc.

### TYPICAL APPLICATION



**PACKAGE REFERENCE**


\* For Tape & Reel, add suffix -Z (eg. MP2105DJ-Z)  
 For Lead Free, add suffix -LF (eg. MP2105DJ-LF-Z)

**ABSOLUTE MAXIMUM RATINGS <sup>(1)</sup>**

$V_{IN}$  to GND ..... -0.3V to +6.5V  
 $V_{SW}$  to GND..... -0.3V to  $V_{IN}$  +0.3V  
 $V_{FB}$ ,  $V_{EN}$  to GND..... -0.3V to +6.5V  
 Junction Temperature..... +150°C  
 Lead Temperature ..... +260°C  
 Storage Temperature ..... -65°C to +150°C

**Recommended Operating Conditions <sup>(2)</sup>**

Supply Voltage  $V_{IN}$ ..... 2.5V to 6V  
 Output Voltage  $V_{OUT}$  ..... 0.6V to 6V  
 Operating Temperature ..... -40°C to +85°C

**Thermal Resistance <sup>(3)</sup>**       $\theta_{JA}$        $\theta_{JC}$   
 TSOT23-5..... 220 .... 110.. °C/W

**Notes:**

- 1) Exceeding these ratings may damage the device.
- 2) The device is not guaranteed to function outside of its operating conditions.
- 3) Measured on approximately 1" square of 1 oz copper.

**ELECTRICAL CHARACTERISTICS <sup>(4)</sup>**

$V_{IN} = V_{EN} = 3.6V$ ,  $T_A = +25^\circ C$ , unless otherwise noted.

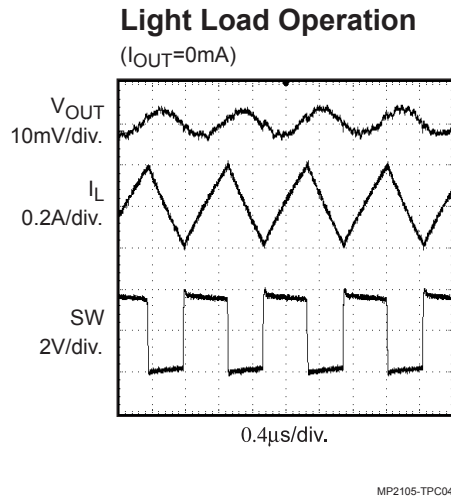
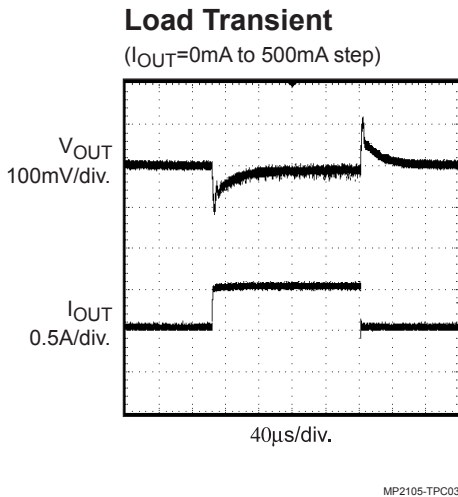
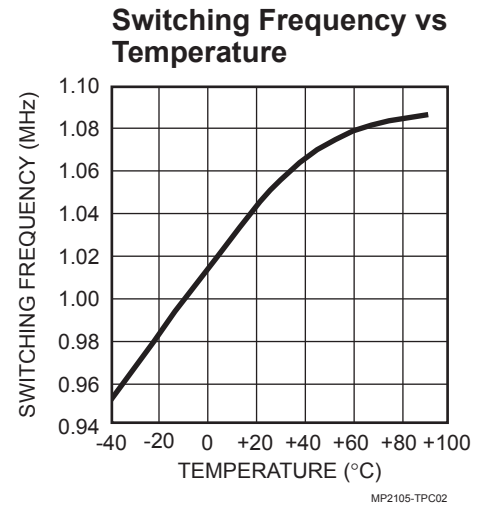
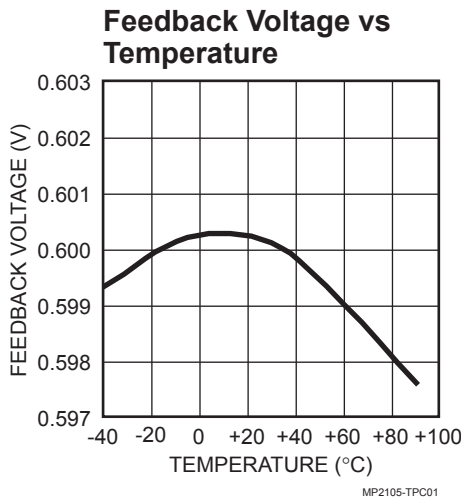
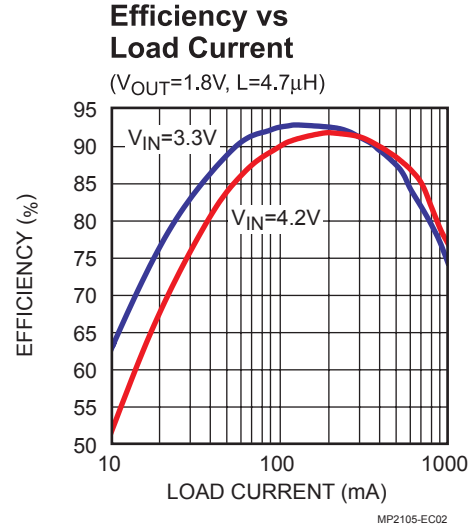
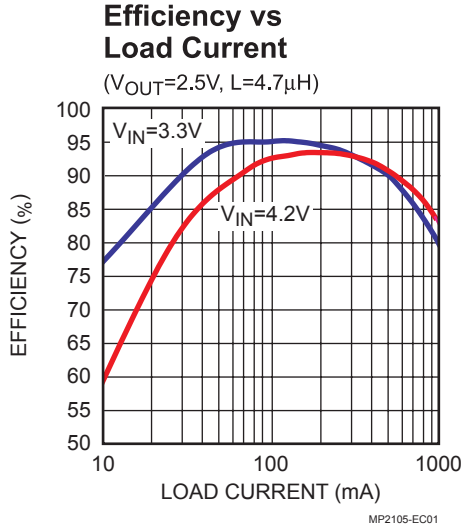
| Parameter                          | Symbol    | Condition  | Min   | Typ   | Max   | Units      |
|------------------------------------|-----------|--|-------|-------|-------|------------|
| Supply Current                     |           | $V_{EN} = V_{IN}$ , $V_{FB} = 0.65V$                     |       | 440   | 600   | $\mu A$    |
| Shutdown Current                   |           | $V_{EN} = 0V$ , $V_{IN} = 6V$                            |       | 0.10  | 1     | $\mu A$    |
| IN Undervoltage Lockout Threshold  |           | Rising Edge  | 2.15  | 2.30  | 2.40  | V          |
| IN Undervoltage Lockout Hysteresis |           |  |       | 55    |       | mV         |
| Regulated FB Voltage               | $V_{FB}$  | $T_A = +25^\circ C$                                      | 0.588 | 0.600 | 0.612 | V          |
|                                    |           | $-40^\circ C \leq T_A \leq +85^\circ C$                  | 0.582 | 0.600 | 0.618 |            |
| FB Input Bias Current              |           | $V_{FB} = 0.65V$   | -50   | 0.5   | +50   | nA         |
| PFET On Resistance                 |           | $I_{SW} = 100mA$   |       | 0.42  |       | $\Omega$   |
| NFET On Resistance                 |           | $I_{SW} = -100mA$  |       | 0.26  |       | $\Omega$   |
| SW Leakage Current                 |           | $V_{EN} = 0V$ , $V_{IN} = 6V$ ,<br>$V_{SW} = 0V$ or $6V$ | -1    |       | +1    | $\mu A$    |
| PFET Current Limit                 |           | Duty Cycle = 100%,<br>Current Pulse Width < 1ms          | 1.2   | 1.6   | 2.1   | A          |
| Oscillator Frequency               | $f_{OSC}$ |  | 0.85  | 1.05  | 1.25  | MHz        |
| Thermal Shutdown Trip Threshold    |           |  |       | 145   |       | $^\circ C$ |
| EN Trip Threshold                  |           | $-40^\circ C \leq T_A \leq +85^\circ C$                  | 0.3   | 0.96  | 1.5   | V          |
| EN Input Current                   |           | $V_{EN} = 0V$ to $6V$                                    | -1    |       | +1    | $\mu A$    |

**Notes:**

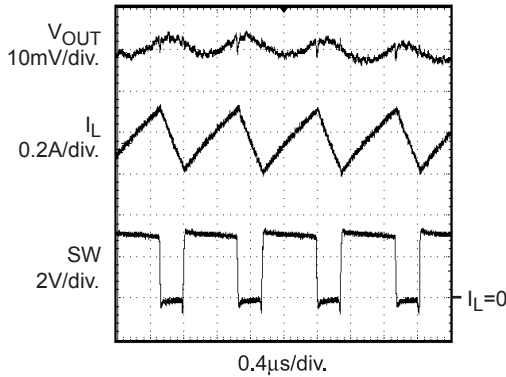
- 4) 100% production test at +25°C. Specifications over the temperature range are guaranteed by design and characterization.

**TYPICAL PERFORMANCE CHARACTERISTICS**

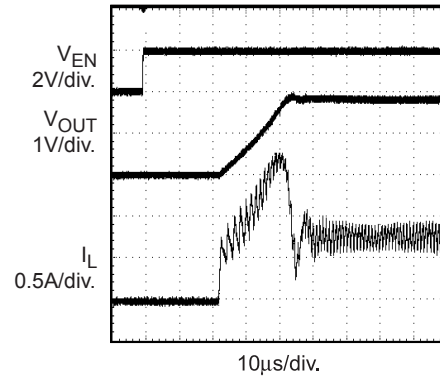
$V_{IN} = 3.3V$ ,  $V_{OUT} = 1.8V$ ,  $L1 = 4.7\mu H$ ,  $C1 = 4.7\mu F$ ,  $C3 = 10\mu F$ ,  $T_A = +25^\circ C$ , unless otherwise noted.



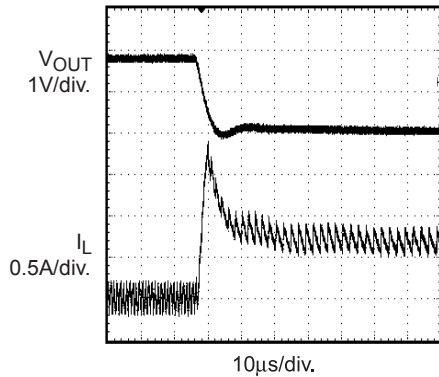
**TYPICAL PERFORMANCE CHARACTERISTICS (continued)**
 $V_{IN} = 3.3V$ ,  $V_{OUT} = 1.8V$ ,  $L1 = 4.7\mu H$ ,  $C1 = 4.7\mu F$ ,  $C3 = 10\mu F$ ,  $T_A = +25^\circ C$ , unless otherwise noted.

**Heavy Load Operation**
 $I_{OUT} = 800mA$ 


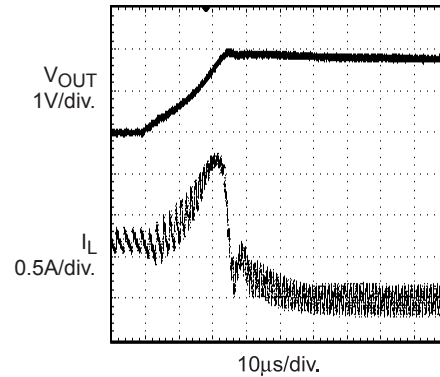
MP2105-TPC07

**Startup from Shutdown**


MP2105-TPC08

**Short Circuit Protection (No Load)**


MP2105-TPC09

**Short Circuit Recovery (No Load)**


MP2105-TPC10

**PIN FUNCTIONS**

| Pin # | Name | Description   |
|-------|------|---|
| EN    | 1    | Regulator Enable Control Input. Drive EN above 1.5V to turn on the MP2105. Drive EN below 0.3V to turn it off (shutdown current < 0.1µA). |
| GND   | 2    | Ground  |
| SW    | 3    | Power Switch Output. Inductor connection to drains of the internal PFET and NFET switches.  |
| IN    | 4    | Supply Input. Bypass to GND with a 2.2µF or greater ceramic capacitor.  |
| FB    | 5    | Feedback Input. Connect FB to the center point of the external resistor divider. The feedback threshold voltage is 0.6V.                  |

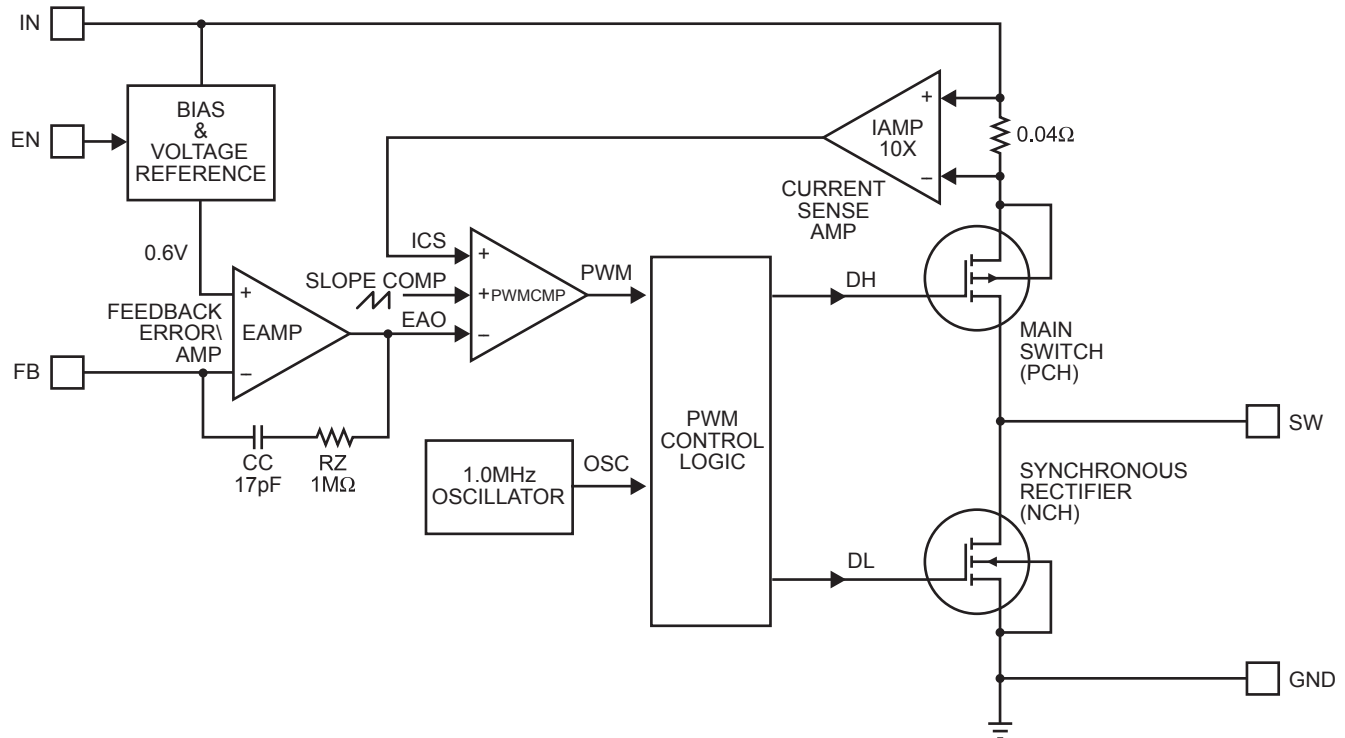
## OPERATION

The MP2105 is a constant frequency current mode PWM step-down converter. The MP2105 is optimized for low voltage, Li-Ion battery powered applications where high efficiency and small size are critical. The MP2105 uses an external resistor divider to set the output voltage from 0.6V to 6V. The device integrates both a main switch and a synchronous rectifier, which provides high efficiency and eliminates

an external Schottky diode. The MP2105 can achieve 100% duty cycle. The duty cycle  $D$  of a step-down converter is defined as:

$$D = T_{ON} \times f_{OSC} \times 100\% \approx \frac{V_{OUT}}{V_{IN}} \times 100\%$$

where  $T_{ON}$  is the main switch on time, and  $f_{OSC}$  is the oscillator frequency (1MHz).



MP2105\_BD01

**Figure 1—Functional Block Diagram**

### Current Mode PWM Control

Slope compensated current mode PWM control provides stable switching and cycle-by-cycle current limit for superior load and line response and protection of the internal main switch and synchronous rectifier. The MP2105 switches at a constant frequency (1MHz) and regulates the output voltage. During each cycle the PWM comparator modulates the power transferred to the load by changing the inductor peak current based on the feedback error voltage. During normal operation, the main switch is turned on for a certain time to ramp the inductor current at each rising edge of the internal oscillator, and switched off when the peak inductor current is above the error voltage. When the main switch is off, the synchronous rectifier will be turned on immediately and stay on until either the next cycle starts.

### Dropout Operation

The MP2105 allows the main switch to remain on for more than one switching cycle and increases the duty cycle while the input voltage is dropping close to the output voltage. When the duty cycle reaches 100%, the main switch is held on continuously to deliver current to the output up to

the PFET current limit. The output voltage then is the input voltage minus the voltage drop across the main switch and the inductor.

### Short Circuit Protection

The MP2105 has short circuit protection. When the output is shorted to ground, the oscillator frequency is reduced to prevent the inductor current from increasing beyond the PFET current limit. The PFET current limit is also reduced to lower the short circuit current. The frequency and current limit will return to the normal values once the short circuit condition is removed and the feedback voltage reaches 0.6V.

### Maximum Load Current

The MP2105 can operate down to 2.5V input voltage; however the maximum load current decreases at lower input due to large IR drop on the main switch and synchronous rectifier. The slope compensation signal reduces the peak inductor current as a function of the duty cycle to prevent sub-harmonic oscillations at duty cycles greater than 50%. Conversely the current limit increases as the duty cycle decreases.

## APPLICATION INFORMATION

### Output Voltage Setting

The external resistor divider sets the output voltage (see Figure 3). The feedback resistor R1 also sets the feedback loop bandwidth with the internal compensation capacitor (see Figure 1).

Choose R1 around 500kΩ for optimal transient response. R2 is then given by:

$$R2 = \frac{R1}{\frac{V_{OUT}}{0.6V} - 1}$$

**Table 1—Resistor Selection vs. Output Voltage Setting**

| V <sub>OUT</sub> | R1         | R2         |
|------------------|------------|------------|
| 1.2V             | 499kΩ (1%) | 499kΩ (1%) |
| 1.5V             | 499kΩ (1%) | 332kΩ (1%) |
| 1.8V             | 499kΩ (1%) | 249kΩ (1%) |
| 2.5V             | 499kΩ (1%) | 158kΩ (1%) |

### Inductor Selection

A 1μH to 10μH inductor with DC current rating at least 25% higher than the maximum load current is recommended for most applications. For best efficiency, the inductor DC resistance shall be <200mΩ. See Table 2 for recommended inductors and manufacturers. For most designs, the inductance value can be derived from the following equation:

$$L = \frac{V_{OUT} \times (V_{IN} - V_{OUT})}{V_{IN} \times \Delta I_L \times f_{OSC}}$$

where ΔI<sub>L</sub> is Inductor Ripple Current. Choose inductor ripple current approximately 30% of the maximum load current, 800mA.

The maximum inductor peak current is:

$$I_{L(MAX)} = I_{LOAD} + \frac{\Delta I_L}{2}$$

Under light load conditions below 100mA, larger inductance is recommended for improved efficiency. Table 3 lists inductors recommended for this purpose.

**Table 2—Suggested Surface Mount Inductors**

| Manufacturer | Part Number | Inductance (μH) | Max DCR (Ω) | Saturation Current (A) | Dimensions L x W x H (mm <sup>3</sup> ) |
|--------------|-------------|-----------------|-------------|------------------------|---|
| Coilcraft    | D01605T-472 | 4.7             | 0.150       | 1.20                   | 5.4 x 4.2 x 1.8                         |
| Toko         | D52LC       | 4.7             | 0.087       | 1.14                   | 5 x 5 x 2                               |
| Sumida       | CR43-4R7    | 4.7             | 0.109       | 1.15                   | 4.3 x 4.8 x 3.5                         |

**Table 3—Inductors for Improved Efficiency at 25mA, 50mA, under 100mA Load.**

| Manufacturer | Part Number   | Inductance (μH) | Max DCR (Ω) | Saturation Current (A) | I <sub>RMS</sub> (A) |
|--------------|---------------|-----------------|-------------|------------------------|----------------------|
| Coilcraft    | DO1605T-103MX | 10              | 0.3         | 1.0                    | 0.9                  |
| Murata       | LQH4C100K04   | 10              | 0.2         | 1.2                    | 0.8                  |
| Sumida       | CR32-100      | 10              | 0.2         | 1.0                    | 0.7                  |
| Sumida       | CR54-100      | 10              | 0.1         | 1.2                    | 1.4                  |

### Input Capacitor Selection

The input capacitor reduces the surge current drawn from the input and switching noise from the device. The input capacitor impedance at the switching frequency shall be less than input source impedance to prevent high frequency switching current passing to the input. Ceramic capacitors with X5R or X7R dielectrics are highly recommended because of their low ESR and small temperature coefficients. For most applications, a 4.7μF capacitor is sufficient.

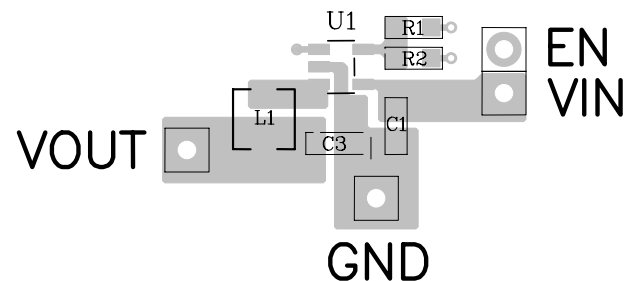
### Output Capacitor Selection

The output capacitor keeps output voltage ripple small and ensures regulation loop stable. The output capacitor impedance shall be low at the switching frequency. Ceramic capacitors with X5R or X7R dielectrics are recommended. The output ripple ΔV<sub>OUT</sub> is approximately:

$$\Delta V_{OUT} \leq \frac{V_{OUT} \times (V_{IN} - V_{OUT})}{V_{IN} \times f_{OSC} \times L} \times \left( ESR + \frac{1}{8 \times f_{OSC} \times C3} \right)$$

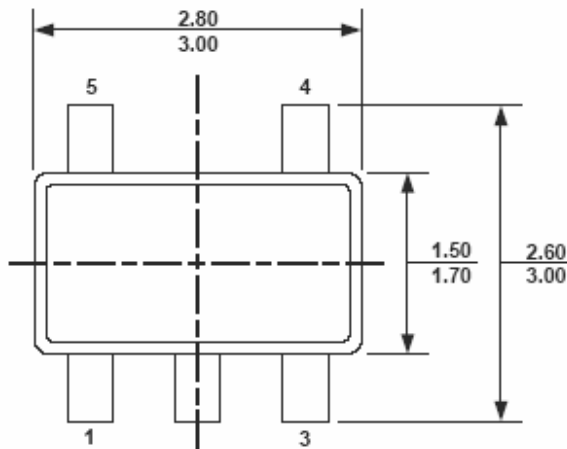
### PC Board Layout

The high current paths (GND, IN and SW) should be placed very close to the device with short, direct and wide traces. Input capacitor C1 needs to be as close as possible to the IN and GND pins. The external feedback resistors shall be placed next to the FB pin. Keep the switching node SW short and away from the feedback network. Figure 2 illustrates an example of PCB layout and signal routing.

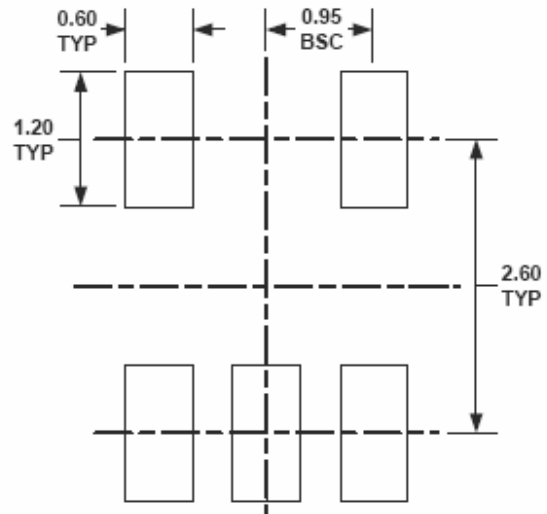

**Figure 2—MP2105 Suggested Layout**

## PACKAGE INFORMATION

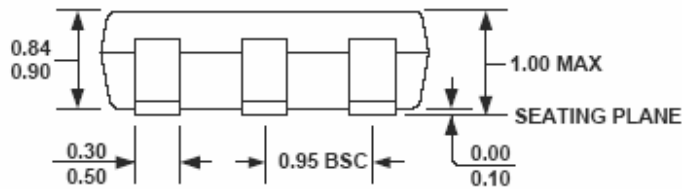
### TSOT23-5



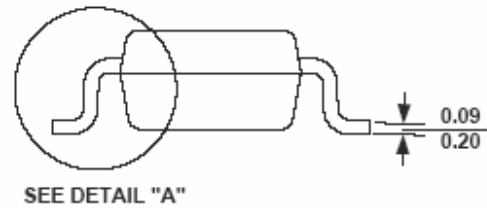
TOP VIEW



RECOMMENDED LAND PATTERN

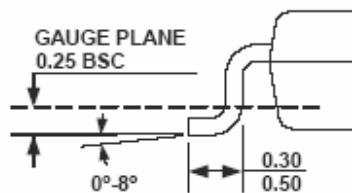


FRONT VIEW



SEE DETAIL "A"

SIDE VIEW



DETAIL "A"

#### NOTE:

- 1) ALL DIMENSIONS ARE IN MILLIMETERS.
- 2) PACKAGE LENGTH DOES NOT INCLUDE MOLD FLASH, PROTRUSION OR GATE BURR.
- 3) PACKAGE WIDTH DOES NOT INCLUDE INTERLEAD FLASH OR PROTRUSION.
- 4) LEAD COPLANARITY (BOTTOM OF LEADS AFTER FORMING) SHALL BE 0.10 MILLIMETERS MAX.
- 5) DRAWING CONFORMS TO JEDEC MO-193, VARIATION AA.
- 6) DRAWING IS NOT TO SCALE.

**NOTICE:** The information in this document is subject to change without notice. Please contact MPS for current specifications. Users should warrant and guarantee that third party Intellectual Property rights are not infringed upon when integrating MPS products into any application. MPS will not assume any legal responsibility for any said applications.