

6367254 MOTOROLA SC (XSTRS/R F)

96D 82613 D
T-29-25

MAXIMUM RATINGS			
Rating	Symbol	Value	Unit
Drain-Source Voltage	V_{DS}	25	Vdc
Drain-Gate Voltage	V_{DG}	30	Vdc
Drain Current	I_D	50	mA
Reverse Gate Current	I_G	-10	mA
Forward Gate Current	I_{GF}	10	mA
Total Device Dissipation @ $T_A = 25^\circ\text{C}$ Derate above 25°C	P_D	360 2.4	mW mW/°C
Total Device Dissipation @ $T_C = 25^\circ\text{C}$ Derate above 25°C	P_D	1.2 0.8	mW mW/°C
Lead Temperature	T_L	300	°C
Operating and Storage Junction Temperature Range	T_J, T_{stg}	-65°C to +175°C	°C

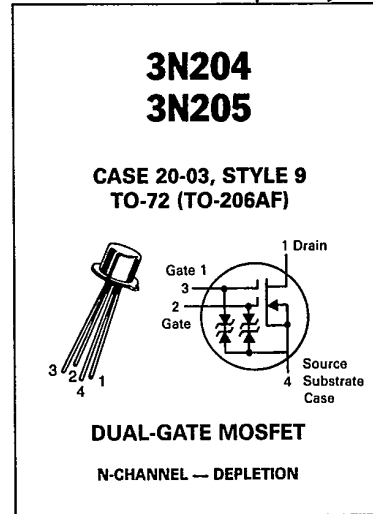

ELECTRICAL CHARACTERISTICS ($T_A = 25^\circ\text{C}$ unless otherwise noted.)

Characteristic	Symbol	Min	Max	Unit
OFF CHARACTERISTICS				
Drain-Source Breakdown Voltage ($I_D = 10 \mu\text{A}, V_{G1} = V_{G2} = -5.0 \text{ V}$)	$V_{(BR)DSX}$	25	—	Vdc
Gate 1-Source Breakdown Voltage ($I_{G1} = \pm 10 \text{ mA}$) Note 1	$V_{(BR)G1SO}$	± 6	± 30	Vdc
Gate 2-Source Breakdown Voltage ($I_{G2} = \pm 10 \text{ mA}$) Note 1	$V_{(BR)G2SO}$	± 6	± 30	Vdc
Gate 1 Leakage Current ($V_{G1S} = \pm 5.0 \text{ V}, V_{G2S} = V_{DS} = 0$)	I_{G1SS}	—	± 10	nA
Gate 2 Leakage Current ($V_{G2S} = \pm 5.0 \text{ V}, V_{G1S} = 0$)	I_{G2SS}	—	± 10	nA
Gate 1 to Source Cutoff Voltage ($V_{DS} = 15 \text{ V}, V_{G2S} = 4.0 \text{ V}, I_D = 20 \mu\text{A}$)	$V_{G1S(off)}$	-0.5	-4.0	Vdc
Gate 2 to Source Cutoff Voltage ($V_{DS} = 15 \text{ V}, V_{G1S} = 0 \text{ V}, I_D = 20 \mu\text{A}$)	$V_{G2S(off)}$	-0.2	-4.0	Vdc
ON CHARACTERISTICS				
Zero-Gate-Voltage Drain Current* ($V_{DS} = 15 \text{ V}, V_{G2S} = 4.0 \text{ V}, V_{G1S} = 0 \text{ V}$)	I_{DSS}^*	6	30	mA
SMALL-SIGNAL CHARACTERISTICS				
Forward Transfer Admittance ($V_{DS} = 15 \text{ V}, V_{G2S} = 4.0 \text{ V}, V_{G1S} = 0 \text{ V}, f = 1.0 \text{ kHz}$) Note 2	$ Y_{fs} $	10	22	mmhos
Input Capacitance ($V_{DS} = 15 \text{ V}, V_{G2S} = 4.0 \text{ V}, I_D = I_{DSS}, f = 1.0 \text{ Mhz}$)	C_{iss}	Typ. 3.0		pF
Reverse Transfer Capacitance ($V_{DS} = 15 \text{ V}, V_{G2S} = 4.0 \text{ V}, I_D = 10 \text{ mA}, f = 1.0 \text{ MHz}$)	C_{rss}	0.005	0.03	pF
Output Capacitance ($V_{DS} = 15 \text{ V}, V_{G2S} = 4.0 \text{ V}, I_D = I_{DSS}, f = 1.0 \text{ MHz}$)	C_{oss}	Typ. 1.4		pF
FUNCTIONAL CHARACTERISTICS				
Noise Figure ($V_{DD} = 18 \text{ V}, V_{GG} = 7.0 \text{ V}, f = 200 \text{ MHz}$) ($V_{DS} = 15 \text{ V}, V_{G2S} = 4.0 \text{ V}, I_D = 10 \text{ mA}, f = 450 \text{ MHz}$)	NF	—	3.5 5.0	dB
Common Source Power Gain ($V_{DD} = 18 \text{ V}, V_{GG} = 7.0 \text{ V}, f = 200 \text{ MHz}$) ($V_{DS} = 15 \text{ V}, V_{G2S} = 4.0 \text{ V}, I_D = 10 \text{ mA}, f = 450 \text{ MHz}$)	G_{ps}	20 14	28 —	dB

6

6367254 MOTOROLA SC (XSTRS/R F)

96D 82614 D

3N204, 3N205

T-29-25

ELECTRICAL CHARACTERISTICS (continued) ($T_A = 25^\circ\text{C}$ unless otherwise noted.)

Characteristic		Symbol	Min	Max	Unit
Bandwidth ($V_{DD} = 18\text{ V}$, $V_{GG} = 7.0\text{ V}$, $f = 200\text{ MHz}$) ($V_{DD} = 18\text{ V}$, $f_{LO} = 245\text{ MHz}$, $f_{RF} = 200\text{ MHz}$) (Note 4)	3N3204	BW	7.0	12	MHz
	3N205		4.0	7.0	
Gain Control Gate-Supply Voltage (Note 3) ($V_{DD} = 18\text{ V}$, $\Delta G_{PS} = 300\text{ dB}$, $f = 200\text{ MHz}$)	3N204	$V_{GG}(GC)$	0	-2.0	Vdc
Conversion Gain (Note 4) ($V_{DD} = 18\text{ V}$, $f_{LO} = 245\text{ MHz}$, $f_{RF} = 200\text{ MHz}$)	3N205	$G_{(conv.)}$	17	28	dB

*PW = 30 μs , Duty Cycle $\leq 2.0\%$.

(1) All gate breakdown voltages are measured while the device is conducting rated gate current. This insures that the gate voltage limiting network is functioning properly.

(2) This parameter must be measured with bias voltages applied for less than five (5) seconds to avoid overheating.

(3) ΔG_{PS} is defined as the change in G_{PS} from the value at $V_{GG} = 7.0\text{ V}$.

(4) Amplitude at input from local oscillator is 3 volts RMS.

6367254 MOTOROLA SC (XSTRS/R F)

96D 82615 D
T-31-25

MAXIMUM RATINGS

Rating	Symbol	Value	Unit
Drain-Source Voltage	V _{DS}	25	Vdc
Drain-Gate Voltage	V _{DG1} V _{DG2}	30 30	Vdc
Drain Current	I _D	30	mAdc
Gate Current	I _{G1R} I _{G1F} I _{G2R} I _{G2F}	-10 10 -10 10	mAdc
Total Device Dissipation @ T _A = 25°C Derate above 25°C	P _D	300 1.71	mW mW/°C
Lead Temperature, 1/16" From Seated Surface for 10 seconds	T _L	260	°C
Storage Channel Temperature Range	T _{stg}	-65 to +175	°C
Operating Channel Temperature	T _{channel}	175	°C

3N209

**CASE 20-03, STYLE 9
TO-72 (TO-206AF)**



**DUAL-GATE MOSFET
UHF COMMUNICATIONS**

N-CHANNEL — DEPLETION

ELECTRICAL CHARACTERISTICS (T_A = 25°C unless otherwise noted.)

Characteristic	Symbol	Min	Typ	Max	Unit
OFF CHARACTERISTICS					
Drain-Source Breakdown Voltage (I _D = 10 μAdc, V _{G1S} = -4.0 Vdc, V _{G2S} = 4.0 Vdc)	V _{(BR)DSX}	25	—	—	Vdc
Gate 1 — Source Forward Breakdown Voltage (I _{G1} = 10 mAdc, V _{G2S} = V _{DS} = 0)	V _{(BR)G1SSF}	7.0	—	22	Vdc
Gate 1 — Source Reverse Breakdown Voltage (I _{G1} = -10 mAdc, V _{G2S} = V _{DS} = 0)	V _{(BR)G1SSR}	-7.0	—	-22	Vdc
Gate 2 — Source Forward Breakdown Voltage (I _{G2} = 10 mAdc, V _{G1S} = V _{DS} = 0)	V _{(BR)G2SSF}	7.0	—	22	Vdc
Gate 2 — Source Reverse Breakdown Voltage (I _{G2} = -10 mAdc, V _{G1S} = V _{DS} = 0)	V _{(BR)G2SSR}	-7.0	—	-22	Vdc
Gate 1 — Terminal Forward Current (V _{G1S} = 6.0 Vdc, V _{G2S} = V _{DS} = 0)	I _{G1SSF}	—	—	20	nAdc
Gate 1 — Terminal Reverse Current (V _{G1S} = -6.0 Vdc, V _{G2S} = V _{DS} = 0) (V _{G1S} = -6.0 Vdc, V _{G2S} = V _{DS} = 0, T _A = 150°C)	I _{G1SSR}	—	—	-20 -10	nAdc μAdc
Gate 2 — Terminal Forward Current (V _{G2S} = 6.0 Vdc, V _{G1S} = V _{DS} = 0)	I _{G2SSF}	—	—	20	nAdc
Gate 2 — Terminal Reverse Current (V _{G2S} = -6.0 Vdc, V _{G1S} = V _{DS} = 0) (V _{G2S} = -6.0 Vdc, V _{G1S} = V _{DS} = 0, T _A = 150°C)	I _{G2SSR}	—	—	-20 -10	nAdc μAdc
ON CHARACTERISTICS					
Gate 1 — Zero Voltage Drain Current (V _{DS} = 15 Vdc, V _{G1S} = 0, V _{G2S} = 4.0 Vdc)	I _{DSS}	5.0	—	30	mAdc
SMALL-SIGNAL CHARACTERISTICS					
Forward Transfer Admittance (V _{DS} = 15 Vdc, V _{G2S} = 4.0 Vdc, I _D = 10 mAdc, f = 1.0 kHz)	Y _{fs}	10	13	20	mmhos
Input Capacitance (V _{DS} = 15 Vdc, V _{G2S} = 4.0 Vdc, I _D ≥ 5.0 mAdc, f = 1.0 MHz)	C _{iss}	—	3.3	7.0	pF
Reverse Transfer Capacitance (V _{DS} = 15 Vdc, V _{G2S} = 4.0 Vdc, I _D ≥ 5.0 mAdc, f = 1.0 MHz)	C _{rss}	0.005	0.023	0.03	pF
Output Capacitance (V _{DS} = 15 Vdc, V _{G2S} = 4.0 Vdc, I _D ≥ 5.0 mAdc, f = 1.0 MHz)	C _{oss}	0.5	2.0	4.0	pF

MOTOROLA SMALL-SIGNAL SEMICONDUCTORS

6

6367254 MOTOROLA SC (XSTRS/R F)

96D 82616 D

3N209

T-31-25

ELECTRICAL CHARACTERISTICS (continued) ($T_A = 25^\circ\text{C}$ unless otherwise noted.)

Characteristic	Symbol	Min	Typ	Max	Unit
FUNCTIONAL CHARACTERISTICS					
Noise Figure ($V_{DS} = 15\text{ Vdc}$, $V_{G2S} = 4.0\text{ Vdc}$, $I_D = 10\text{ mAdc}$, $f = 500\text{ MHz}$)	NF	—	4.0	6.0	dB
Common Source Power Gain (Figure 12) ($V_{DS} = 15\text{ Vdc}$, $V_{G2S} = 4.0\text{ Vdc}$, $I_D = 10\text{ mAdc}$, $f = 500\text{ MHz}$)	G_{ps}	10	13	20	dB
*Bandwidth ($V_{DS} = 15\text{ Vdc}$, $V_{G2S} = 4.0\text{ Vdc}$, $I_D = 10\text{ mAdc}$, $f = 500\text{ MHz}$)	BW	7.0	—	17	MHz

FIGURE 1 - MOSFET CIRCUIT SCHEMATIC

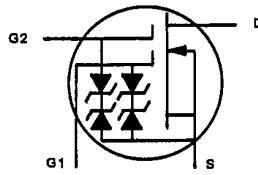

6

TYPICAL SCATTERING PARAMETERS

FIGURE 2 - S_{11} , INPUT REFLECTION COEFFICIENT

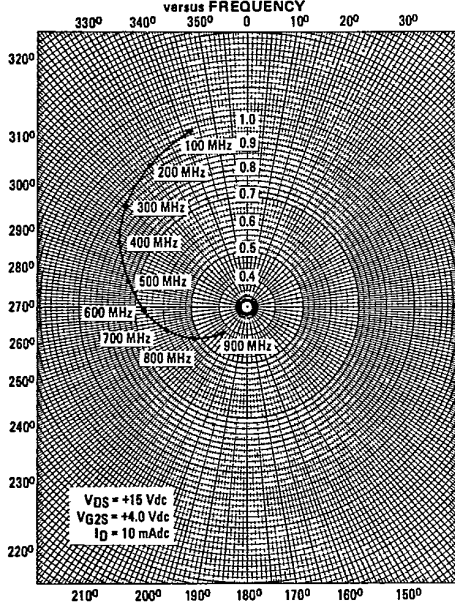
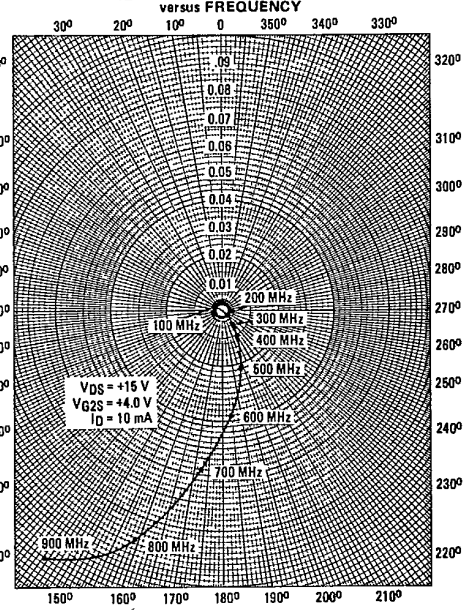

FIGURE 3 - S_{12} , REVERSE TRANSMISSION COEFFICIENT



6367254 MOTOROLA SC (XSTRS/R F)
3N209

96D 82617 D
T-31-25

FIGURE 4 - S_{21} , FORWARD TRANSMISSION COEFFICIENT versus FREQUENCY

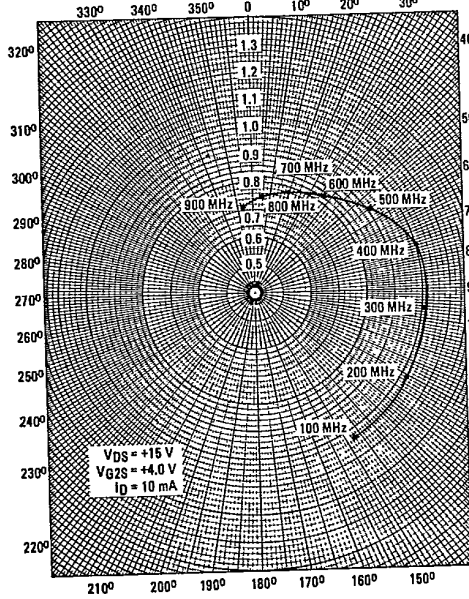
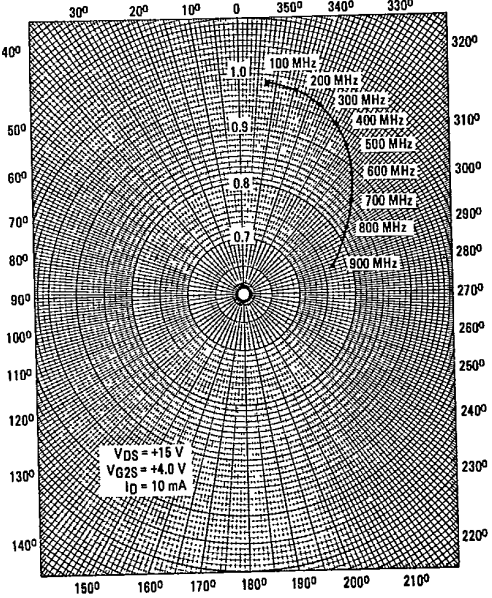

FIGURE 5 - S_{22} , OUTPUT REFLECTION COEFFICIENT versus FREQUENCY



TYPICAL COMMON-SOURCE ADMITTANCE PARAMETERS
($V_{DS} = 15$ Vdc, $V_{GS2} = 4.0$ Vdc, $I_D = 10$ mA)

FIGURE 6 - Y_{11} , INPUT ADMITTANCE versus FREQUENCY

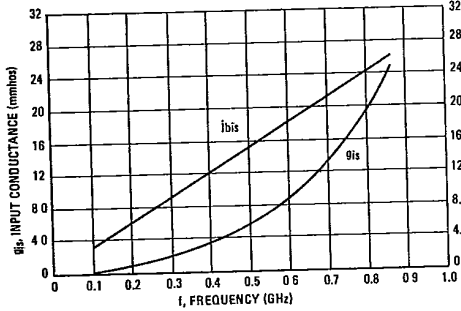
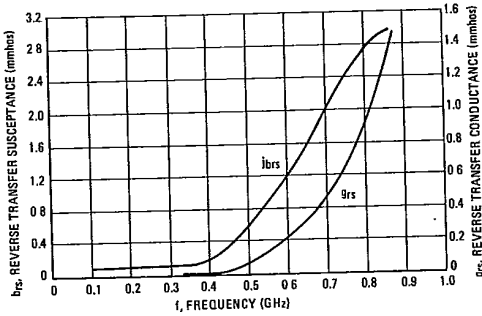

FIGURE 7 - Y_{12} , REVERSE TRANSFER ADMITTANCE versus FREQUENCY



6367254 MOTOROLA SC (XSTRS/R F)

96D 82618 D

3N209

T-31-25

FIGURE 8 - Y_{21} , FORWARD TRANSFER ADMITTANCE versus FREQUENCY

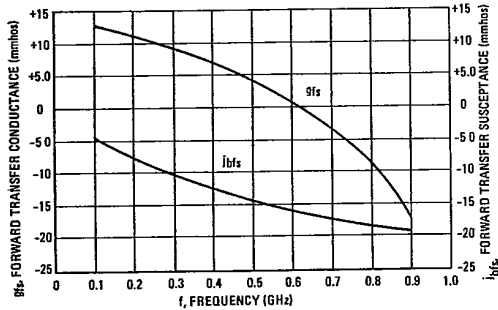

FIGURE 9 - Y_{22} , OUTPUT ADMITTANCE versus FREQUENCY

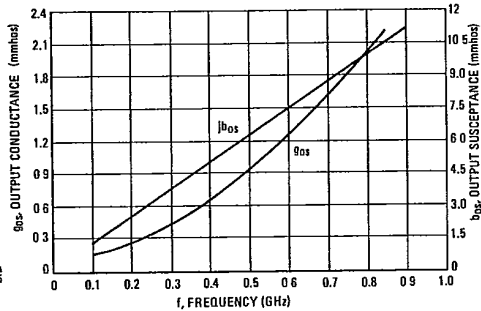
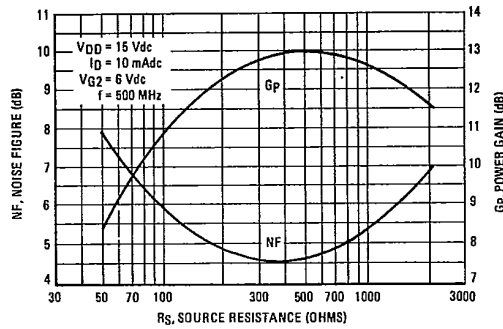

FIGURE 10 - POWER GAIN AND NOISE FIGURE versus SOURCE RESISTANCE (See Schematic Figure 12)



6

The Test Circuit shown in Figure 12 was used to generate Power Gain and Noise Figure as a function of Source Resistance curves.

FIGURE 11 - THIRD ORDER INTERMODULATION DISTORTION (See Schematic Figure 12)

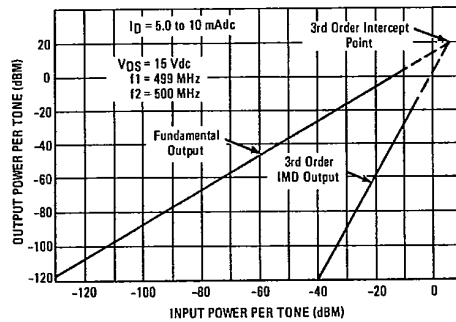

Figure 11 shows the typical third order intermodulation distortion (IMD) performance of the 3N209 and 3N210 at 500 MHz.

Both fundamental output and third order IMD output characteristics are plotted. The curves have been extrapolated to show the third order intermodulation output intercept point.

The performance is typical for I_D between 5.0 mA dc and 10 mA dc. The test circuit shown in Figure 12 was used to generate the IMD Data.

6367254 MOTOROLA SC (XSTRS/R F)

96D 82619 D

3N209

T-31-25

FIGURE 12 - TEST CIRCUIT FOR POWER GAIN, NOISE FIGURE AND THIRD ORDER INTERMODULATION DISTORTION

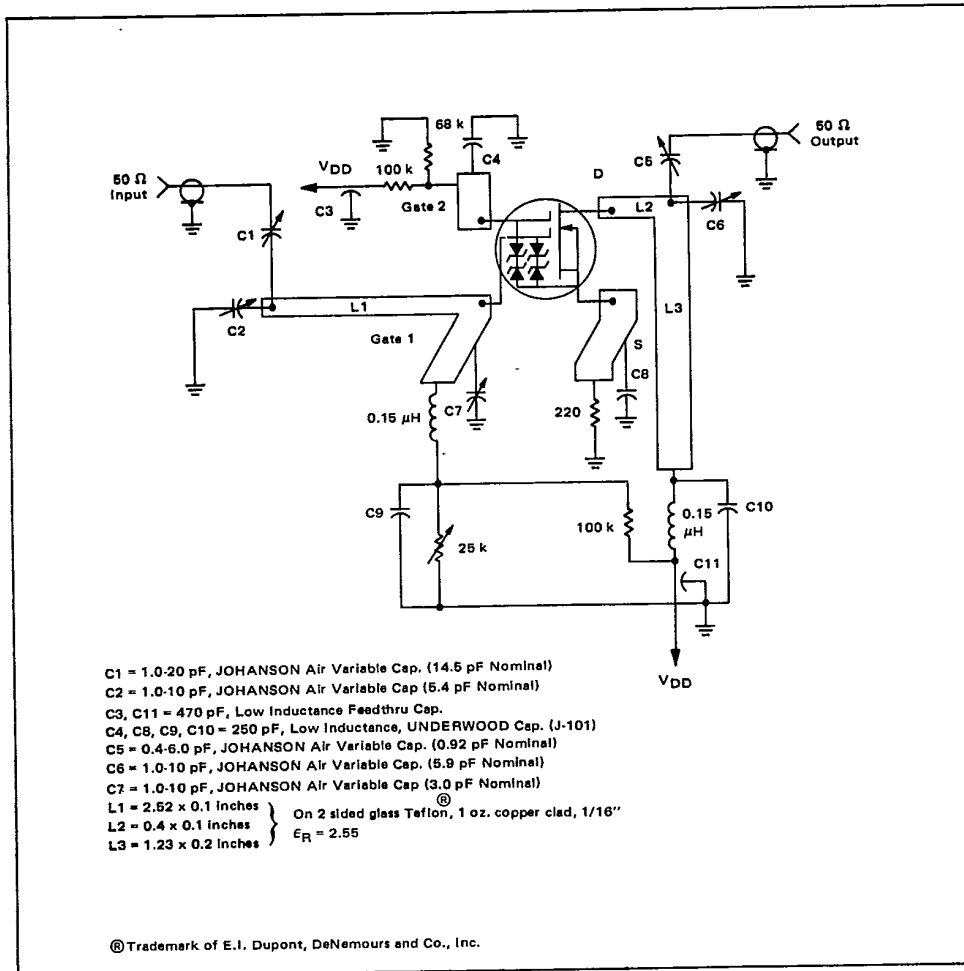

6