

Wideband Downconverter

0.7 - 2.5 GHz

MD59-0044

Features

- Broadband performance, 700 - 2500 MHz
- Single 2.8 V Supply
- Ultra low current draw, 6 mA Typical
- High linearity, IP_3 9 dBm Typical
- Adjustable gain and IP_3
- Miniature SOT-26 Plastic Package

Description

M/A-COM's MD59-0044 is a wideband downconverter suitable for cellular and PCS mobile phones, wireless LAN ISM and other battery operated RF applications that require wide dynamic range and low power consumption. The MD59-0044 has 50 ohm matched inputs, consuming low DC power, and can operate with input frequencies from 700 MHz to 2.5 GHz, as determined by external matching components. By selecting suitable off-chip resistors, the designer can tailor the linearity and gain performance of the MD59-0044 according to the system's needs.

M/A-COM fabricates the MD59-0044 using a 0.5 micron low noise GaAs MESFET process. The process features full passivation for high performance and reliability.

Functional Schematic

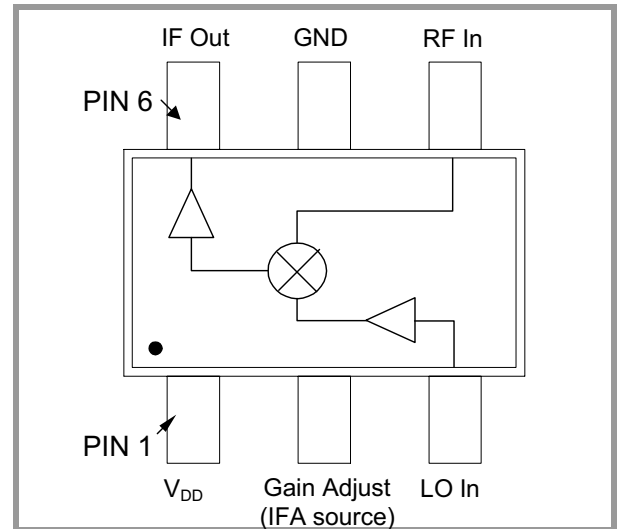

Recommended PCB Configuration

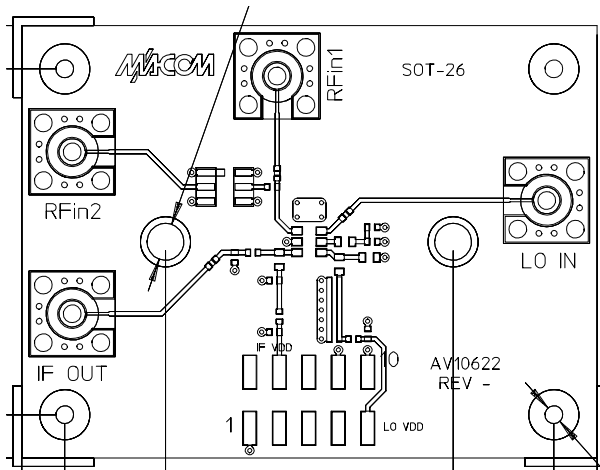

Pin Configuration

PIN No.	PIN Name	Description
1	LOA V_{DD}	LO bias, tuning: series L and shunt C determine the operating band.
2	IFA Source	Parallel RC network determines the IFA current, gain and IP_3 .
3	LO In	LO Input (50 Ohms), DC blocked.
4	RF In	RF Input (50 Ohms), DC blocked.
5	Ground	DC and RF Ground
6	IF Out	IF Output. V_{DD} and IF matching required.

Electrical Specifications $T_A = +25^\circ\text{C}$

Parameter	Test Conditions	Units	Min.	Typ.	Max.
General					
RF Frequency		MHz	700		2500
LO Frequency		MHz	700		2500
IF Frequency		MHz	50		500
LO Input Level		dBm	-7	-4	3
I_{DD}	<ul style="list-style-type: none"> Cellular Band PCS Band 	mA	-5	5	15 15
V_{DD}		V	2.5	2.8	4.5
Cellular Band ($V_{DD} = 2.8\text{ V}$, $I_{DD} = 5\text{ mA}$, RF = 881 MHz, LO = 996 MHz @ -4 dBm, IF = 85 MHz)					
Conversion Gain		dB		7	
Noise Figure	SSB NF calculated by adding 3 dB to DSB NF	dB		8.5	
Input Intercept Point		dBm		9	
RF-to-IF Isolation	After IF match	dB		25	
LO-to-IF Isolation	After IF match	dB		40	
RF Return Loss		dB	10		
LO Return Loss		dB	10		
Supply Current		mA		5	
PCS Band ($V_{DD} = 2.8\text{ V}$, $I_{DD} = 7\text{ mA}$, RF = 1960 MHz, LO = 1750 MHz @ -4 dBm, IF = 210 MHz)					
Conversion Gain		dB		5.5	
Noise Figure	SSB NF calculated by adding 3 dB to DSB NF	dB		9.5	
Input Intercept Point		dBm		10	
RF-to-IF Isolation	After IF match	dB		40	
LO-to-IF Isolation	After IF match	dB		55	
RF Return Loss		dB	10		
LO Return Loss		dB	10		
Supply Current		mA		7	
ISM Band ($V_{DD} = 2.7\text{ V}$, RF = 2443 MHz, LO = 2203 MHz @ -4 dBm, IF = 240 MHz)					
Conversion Gain		dB		4	
Noise Figure		dB		10	
Input Intercept Point		dBm		9	
RF Return Loss		dB	10		
LO Return Loss		dB	10		
RF-to-IF Isolation		dB	30		
LO-to-IF Isolation		dB	30		
Supply Current		mA		7	

Specifications subject to change without notice.

- North America: Tel. (800) 366-2266, Fax (800) 618-8883
- Asia/Pacific: Tel. +81-44-844-8296, Fax +81-44-844-8298
- Europe: Tel. +44 (1344) 869 595, Fax +44 (1344) 300 020

Visit www.macom.com for additional data sheets and product information.

tyco / Electronics

MACOM

Operating Instructions

The MD59-0044 is a highly integrated MMIC downconverter that operates with RF input frequencies from 700MHz to 2500MHz. The downconverter provides exceptional RF performance while drawing low DC current and is packaged in a low cost SOT-26 plastic package. It is an ideal candidate for lightweight, battery operated, portable handset applications.

The MD59-0044 incorporates an LO buffer amplifier, a passive mixer and an IF amplifier FET as shown in the block diagram. Surface mount resistors, inductors, and capacitors are used in conjunction with the MMIC to optimize the trade-offs among performance, tuneability, and ease of use. The schematic on the previous page shows the MMIC and required off-chip component values for each operating band.

Pin 1: LO Amplifier Tuning

The frequency response of the LO amp, along with the broad band matched RF input (Pin 4), determines the frequency conversion characteristics of the device. Therefore, it is very important to ensure that the LO amp is working properly at the given LO power level.

The drain output of the LO amp (PIN 1), requires an external series inductor L1 and RF bypass capacitor C1 since the input capacitance looking into Pin 1 is approximately 1.5pF, the value of L1 that resonates at the LO frequency can be calculated with the following equation:

$$L = \frac{1}{C(2\pi f)^2}$$

$$L(nH) = \frac{16.89}{(f(GHz))^2}$$

Once the value of L1 is calculated, proper operation of the device must be confirmed by measurement. The simplest and most efficient way to do this is to look at the conversion gain response over the RF band. If the conversion gain monotonically increases with frequency, then the value of L1 should increase, or vice versa. Note that the distance between L1 and C1 affects the tuning of the LO amp. As C1 is placed farther from L1, this will lower the operating LO amplifier frequency.

It is recommend that a high Q inductor is used for L1.

Pin 2: IF Amplifier Source/ RF Ground

By selecting a resistor to ground connected to Pin 2, the operating point on the gain versus DC current curve can be set. Using the conversion gain and the IP3 vs. I_{DD} graphs provided in this data sheet, select the desired current level for application. Once the DC current level is selected the value of R1 can be determined using the DC current Vs. R1 value plot provided in this datasheet.

Pin 2 is also internally connected to RF ground. Therefore, you should place the RF / IF bypass capacitor C7 physically as close to the pin as possible.

Pin 3: DC Blocked LO Input

The LO input port is internally matched to 50 ohms. The LO buffer amplifier provides the voltage gain required to drive the gate of the mixer FET, while drawing a minimum amount of current. The LO buffer amplifies LO input signals as low in power as -7 dBm to the level required to drive the mixer. For optimum performance, a drive level of -4 dBm is recommended (refer to the conversion gain and IP3 vs. PLO graphs).

Pin 4: DC Blocked RF Input

The RF input port is matched from 700 MHz to 2500 MHz to 50 ohms and an internal DC blocking capacitor is included.

Pin 5: RF / DC Ground

Pin 5 is the RF and DC ground. For the best port-to-port isolation, ground vias as close to the device as possible.

Pin 6: IF Amplifier Output

Pin 6 is the open drain output of the IF amplifier FET, and is matched externally to 50 ohms using L2, C2, C3 and C4. The impedance looking from the Pin 6 is plotted over the IF frequency range in Figure 1. Capacitor C2 is an IF frequency bypass capacitor. Inductor L2, in association with capacitors C3 and C4, forms a low impedance transformer, and acts as an RF choke for the DC supply lines. In addition, C3 also acts as DC blocking capacitor for the IF output.

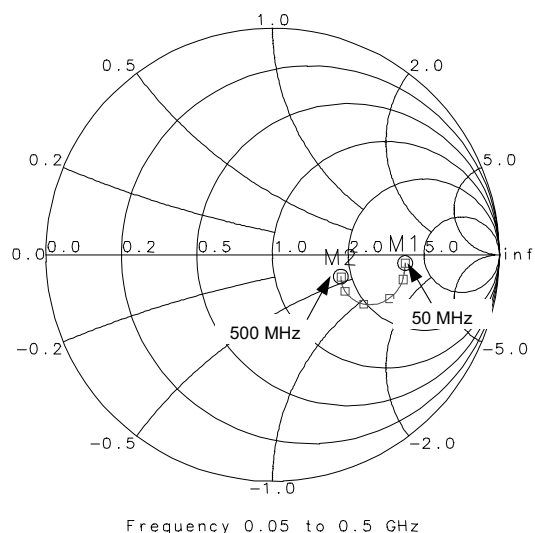

Figure 1: Impedance seen looking out of Pin 6.

Specifications subject to change without notice.

- North America: Tel. (800) 366-2266, Fax (800) 618-8883
- Asia/Pacific: Tel. +81-44-844-8296, Fax +81-44-844-8298
- Europe: Tel. +44 (1344) 869 595, Fax +44 (1344) 300 020

Visit www.macom.com for additional data sheets and product information.

tyco / Electronics

MACOM

Sample Board Schematic

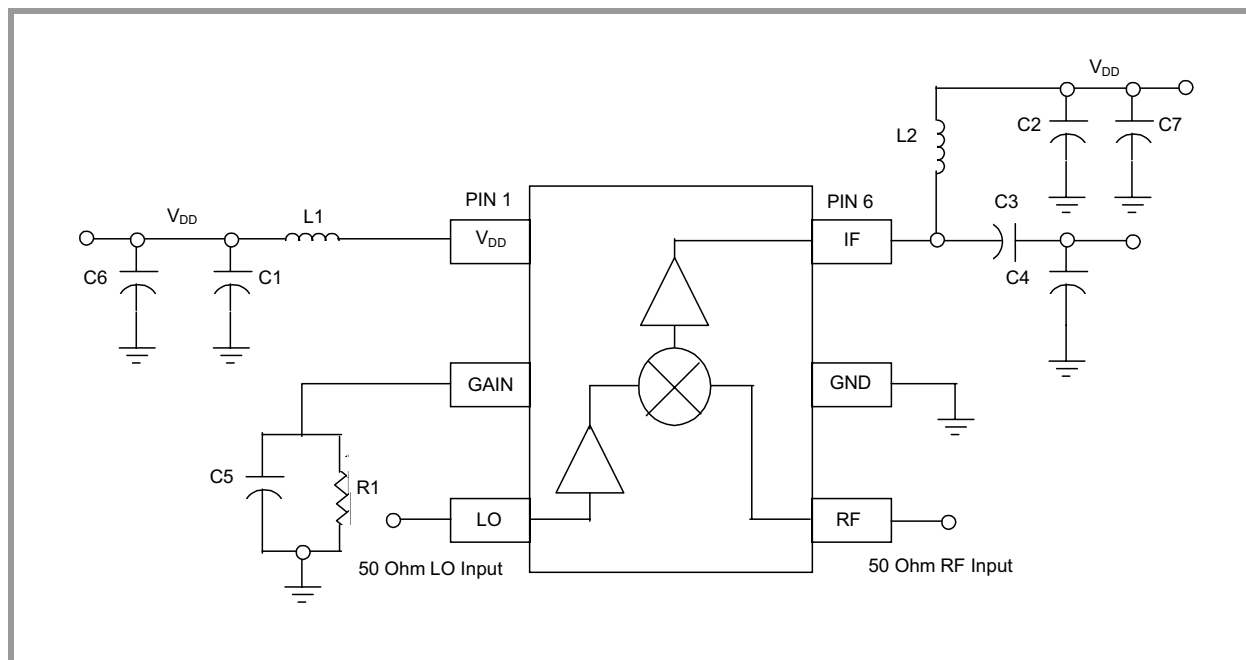

External Circuitry Parts List

Ref. Designation	PCS Value	Cellular Value	ISM Value	Purpose
C1	1000 pF	1000 pF	1000 pF	V _{DD} Decoupling
C2	1000 pF	1000 pF	1000 pF	V _{DD} Shunt
C3	20 pF	22 pF	18 pF	DC Blocking, IF Match
C4	22 pF	22 pF	18 pF	Isolation Shunt
C5	0.1 μF	0.1 μF	0.1 μF	IFA Source Bypass
C6	0.1 μF	0.1 μF	0.1 μF	V _{DD} Decoupling
C7	0.1 μF	0.1 μF	0.1 μF	V _{DD} Decoupling
L1	5.1 nH	16 nH	1.8 nH	LO Buffer Tuning
L2	39 nH	180 nH	38 nH	Decoupling
R1	200 Ohm	360 Ohm	200 Ohm	Current Setting

Specifications subject to change without notice.

- North America: Tel. (800) 366-2266, Fax (800) 618-8883
- Asia/Pacific: Tel. +81-44-844-8296, Fax +81-44-844-8298
- Europe: Tel. +44 (1344) 869 595, Fax +44 (1344) 300 020

Visit www.macom.com for additional data sheets and product information.

tyco / Electronics

MACOM

Typical Performance Curves

Cellular Band

$V_{DD} = 2.8\text{ V}$, $I_{DD} = 5\text{ mA}$, $T_A = 25^\circ\text{ C}$, $R_F = 880\text{ MHz}$, $LO = 965\text{ MHz}$, $IF = 85\text{ MHz}$, $LO\text{ Power} = -4\text{ dBm}$ (unless otherwise noted)

Conversion Gain vs. LO Power

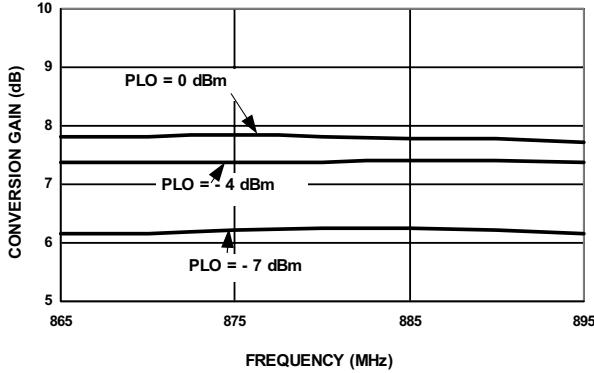

IIP₃ vs. LO Power

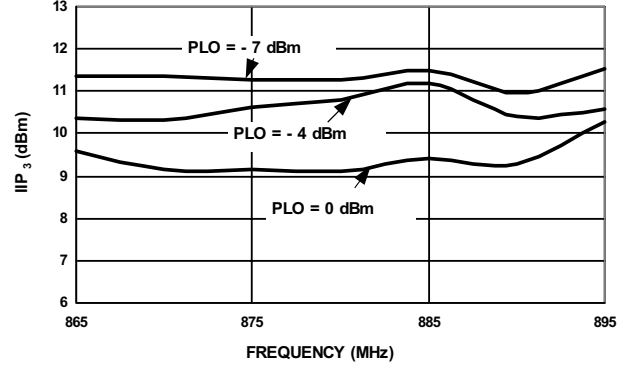

OIP₃ vs. LO Power

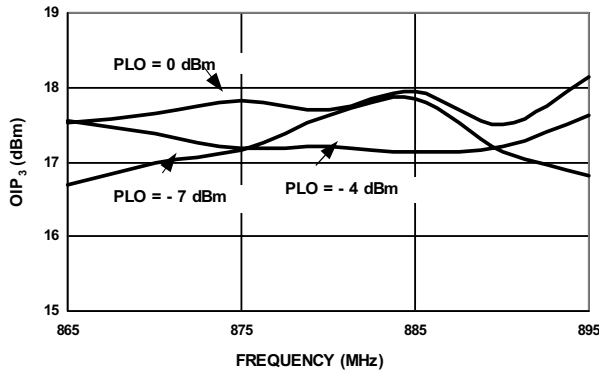

Conversion Gain vs. Temperature
 $I_{DD} = 4.9\text{ mA}$, $R_{F\text{IN}} = -27\text{ dBm}$

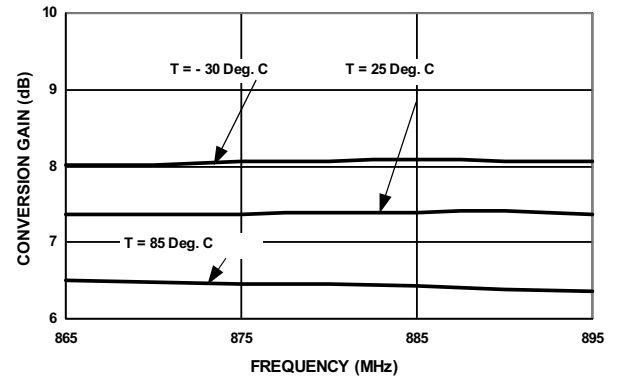

IIP₃ vs. Temperature
 $I_{DD} = 4.9\text{ mA}$, $R_{F\text{IN}} = -27\text{ dBm}$

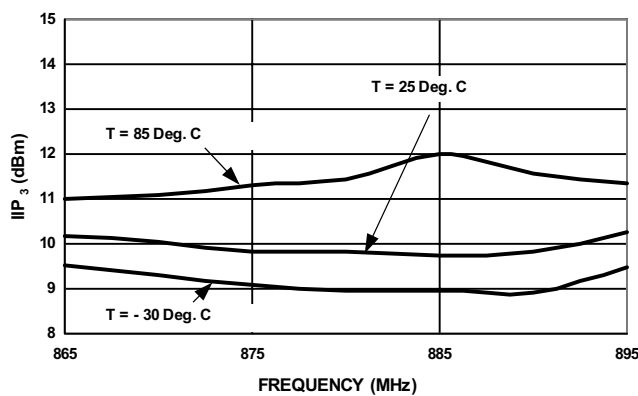

DC Current vs. R1 Value

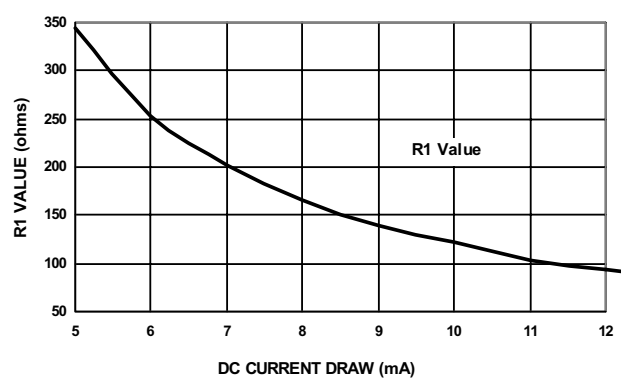

Specifications subject to change without notice.

- North America: Tel. (800) 366-2266, Fax (800) 618-8883
- Asia/Pacific: Tel.+81-44-844-8296, Fax +81-44-844-8298
- Europe: Tel. +44 (1344) 869 595, Fax+44 (1344) 300 020

Visit www.macom.com for additional data sheets and product information.



Typical Performance Curves (Cont'd)

Cellular Band (Cont'd)

$V_{DD} = 2.8\text{ V}$, $I_{DD} = 5\text{ mA}$, $T_A = 25^\circ\text{ C}$, $RF = 880\text{ MHz}$, $LO = 965\text{ MHz}$, $IF = 85\text{ MHz}$, $LO\text{ Power} = -4\text{ dBm}$
(unless otherwise noted)

DC Current vs. Temperature
(matched for cellular band)

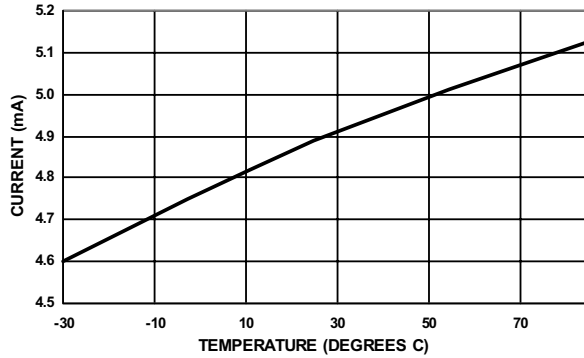

Noise Figure vs. Temperature

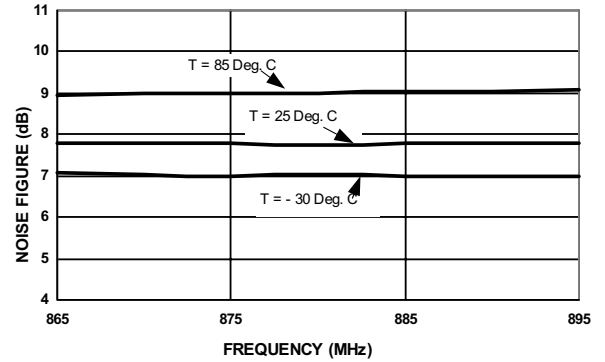

OIP₃ and Conversion Gain vs. LO Power
 $I_{DD} = 4.9\text{ mA}$, $RF = 881.5\text{ MHz}$, $RF_{IN} = -28\text{ dBm}$

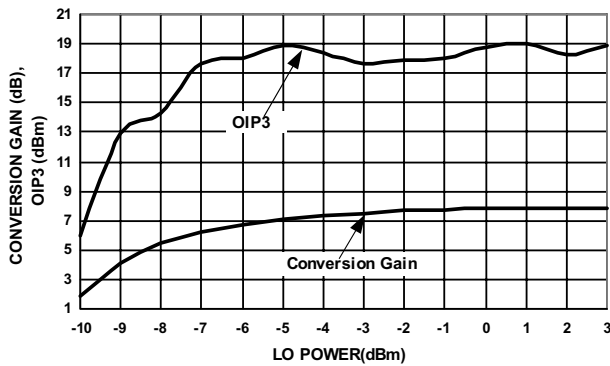

Conversion Gain & OIP₃ vs. DC Current

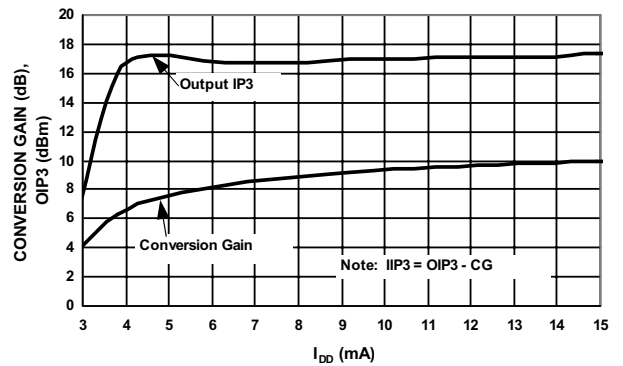

LO - IF Isolation vs. LO Power
 $RF\text{ Power} = -30\text{ dBm}$

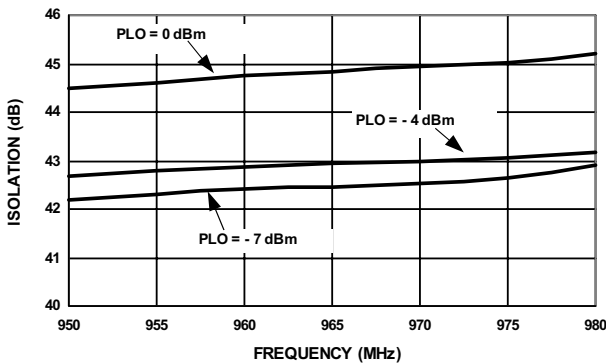

RF - IF Isolation vs. LO Power
 $RF\text{ Power} = -30\text{ dBm}$

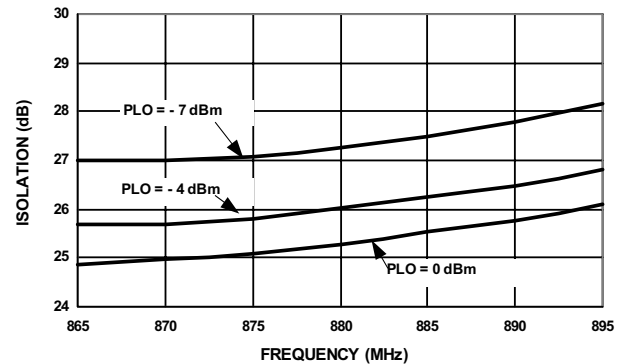

Specifications subject to change without notice.

- North America: Tel. (800) 366-2266, Fax (800) 618-8883
- Asia/Pacific: Tel.+81-44-844-8296, Fax +81-44-844-8298
- Europe: Tel. +44 (1344) 869 595, Fax+44 (1344) 300 020

Visit www.macom.com for additional data sheets and product information.



Typical Performance Curves (Cont'd)

Cellular Band (Cont'd)

$V_{DD} = 2.8\text{ V}$, $I_{DD} = 5\text{ mA}$, $T_A = 25^\circ\text{ C}$, $RF = 880\text{ MHz}$, $LO = 965\text{ MHz}$, $IF = 85\text{ MHz}$, $LO\text{ Power} = -4\text{ dBm}$
(unless otherwise noted)

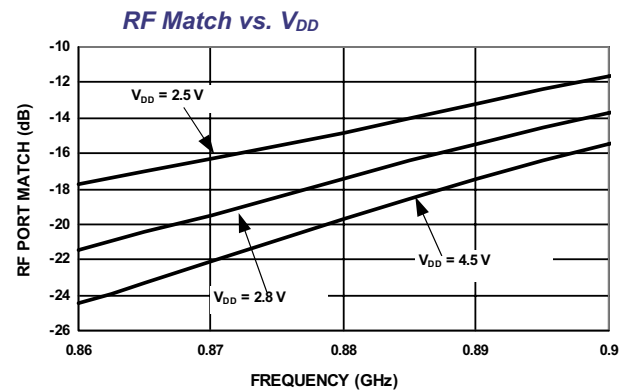
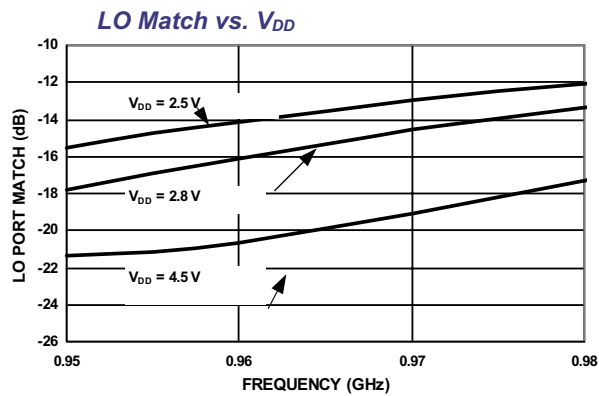
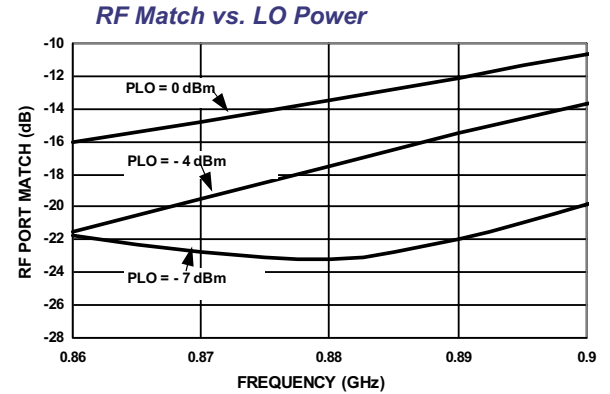
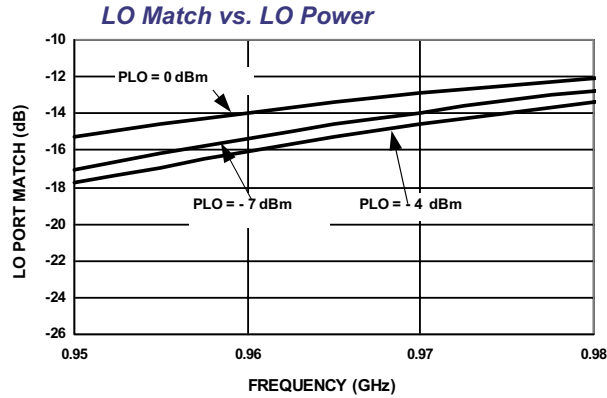

Korean PCS Band

$V_{DD} = 2.8\text{ V}$, $I_{DD} = 7\text{ mA}$, $T_A = 25^\circ\text{ C}$, $RF = 1855\text{ MHz}$, $LO = 1635\text{ MHz}$, $IF = 22\text{ MHz}$, $LO\text{ Power} = -4\text{ dBm}$
(unless otherwise noted)

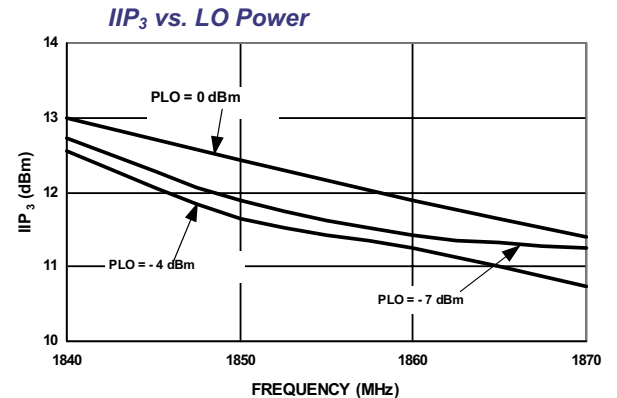
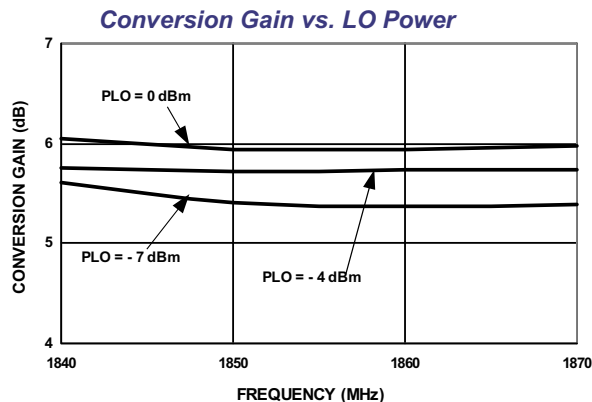

Specifications subject to change without notice.

- North America: Tel. (800) 366-2266, Fax (800) 618-8883
- Asia/Pacific: Tel. +81-44-844-8296, Fax +81-44-844-8298
- Europe: Tel. +44 (1344) 869 595, Fax +44 (1344) 300 020

Visit www.macom.com for additional data sheets and product information.

tyco / Electronics

MACOM

Typical Performance Curves (Cont'd)

Korean PCS Band (Cont'd)

$V_{DD} = 2.8\text{ V}$, $I_{DD} = 7\text{ mA}$, $T_A = 25^\circ\text{ C}$, $RF = 1855\text{ MHz}$, $LO = 1635\text{ MHz}$, $IF = 22\text{ MHz}$, $LO\text{ Power} = -4\text{ dBm}$ (unless otherwise noted)

OIP₃ vs. LO Power

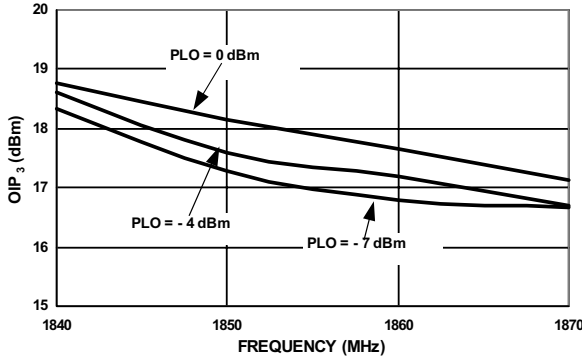

Conversion Gain Over Temperature

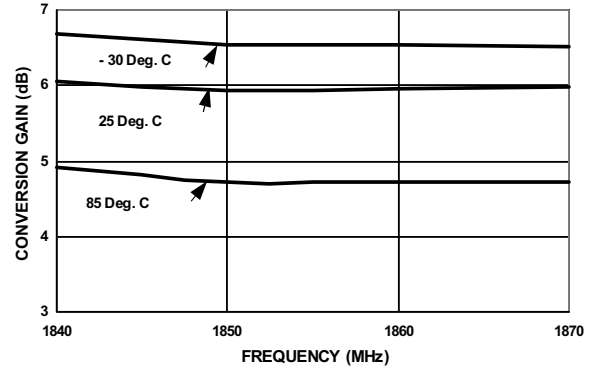

IIP₃ Over Temperature

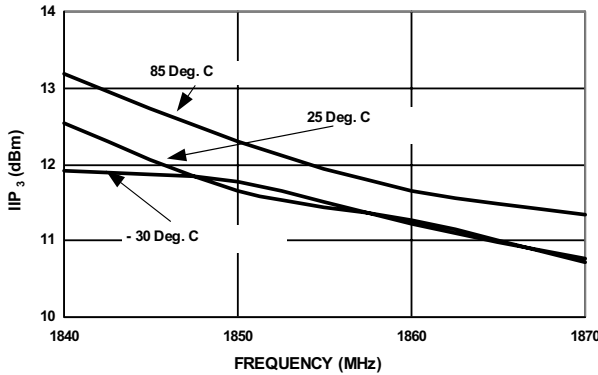

DC Current vs. R1 Value

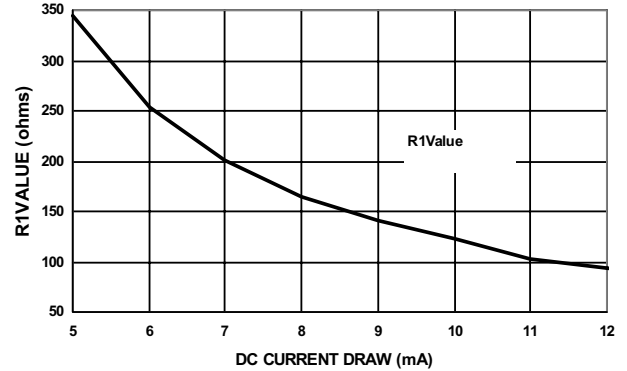

Noise Figure vs. LO Power

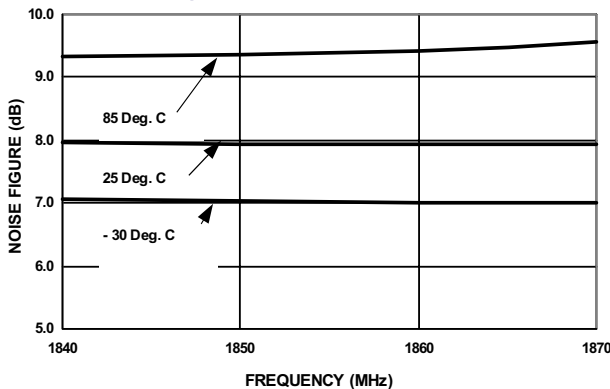

DC Current vs. Temperature (matched for cellular band)

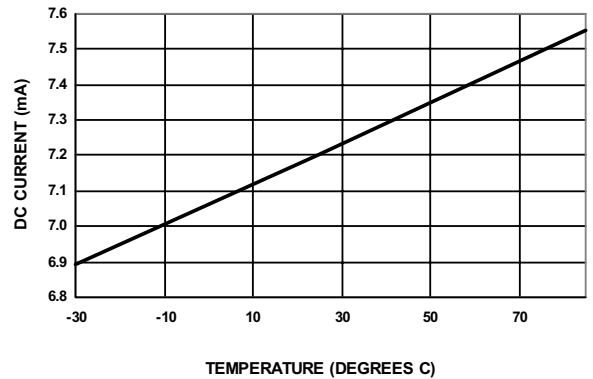

Specifications subject to change without notice.

- North America: Tel. (800) 366-2266, Fax (800) 618-8883
- Asia/Pacific: Tel.+81-44-844-8296, Fax +81-44-844-8298
- Europe: Tel. +44 (1344) 869 595, Fax+44 (1344) 300 020

Visit www.macom.com for additional data sheets and product information.



Typical Performance Curves (Cont'd)

Korean PCS Band (Cont'd)

$V_{DD} = 2.8\text{ V}$, $I_{DD} = 7\text{ mA}$, $T_A = 25^\circ\text{ C}$, $RF = 1855\text{ MHz}$, $LO = 1635\text{ MHz}$, $IF = 22\text{ MHz}$, $LO\text{ Power} = -4\text{ dBm}$ (unless otherwise noted)

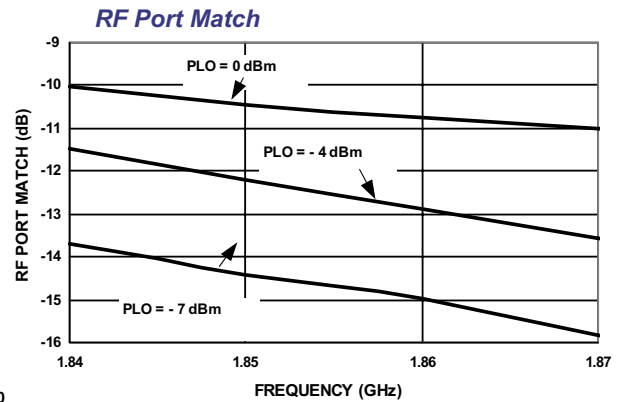
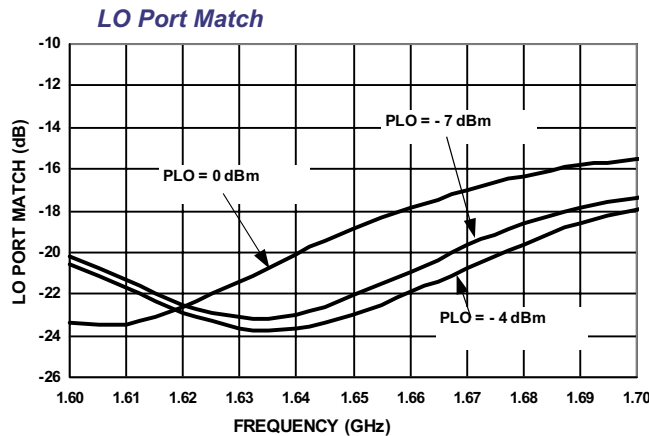
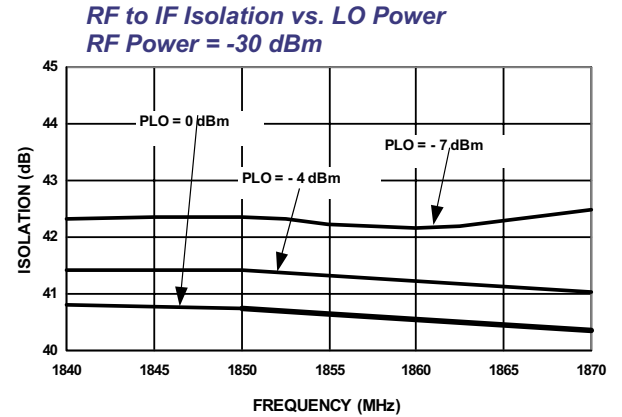
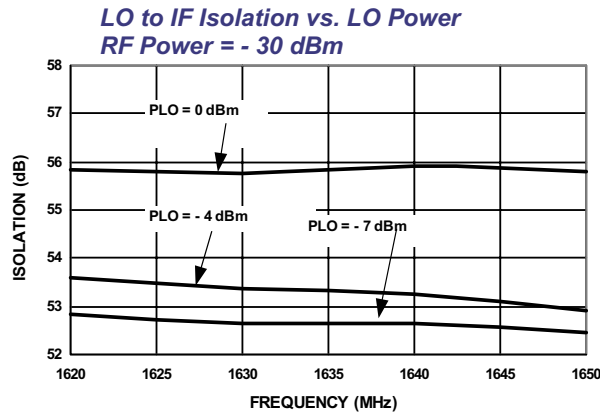
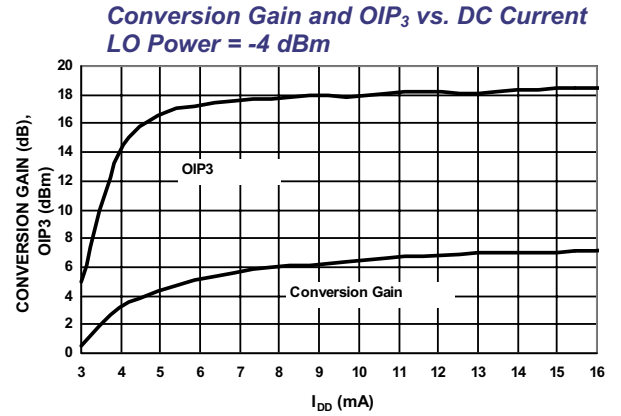
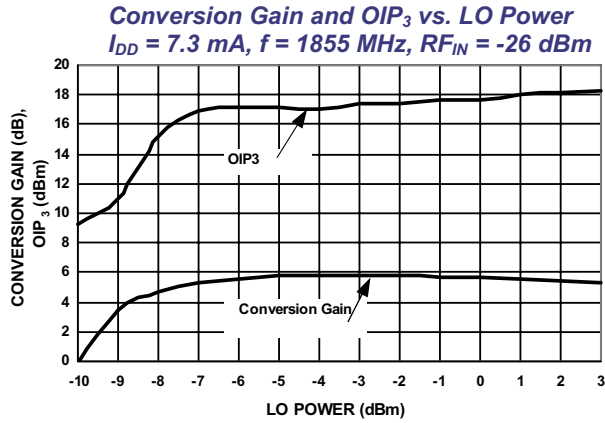

Specifications subject to change without notice.

- North America: Tel. (800) 366-2266, Fax (800) 618-8883
- Asia/Pacific: Tel.+81-44-844-8296, Fax +81-44-844-8298
- Europe: Tel. +44 (1344) 869 595, Fax+44 (1344) 300 020

Visit www.macom.com for additional data sheets and product information.



Typical Performance Curves (Cont'd)

Korean PCS Band (Cont'd)

$V_{DD} = 2.8\text{ V}$, $I_{DD} = 7\text{ mA}$, $T_A = 25^\circ\text{ C}$, $RF = 1855\text{ MHz}$, $LO = 1635\text{ MHz}$, $IF = 22\text{ MHz}$, $LO\text{ Power} = -4\text{ dBm}$ (unless otherwise noted)

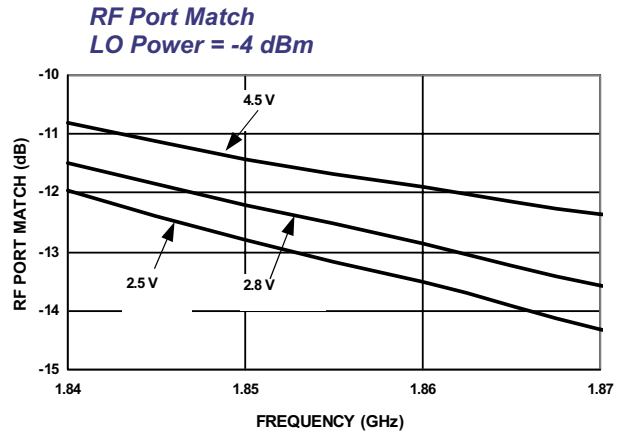
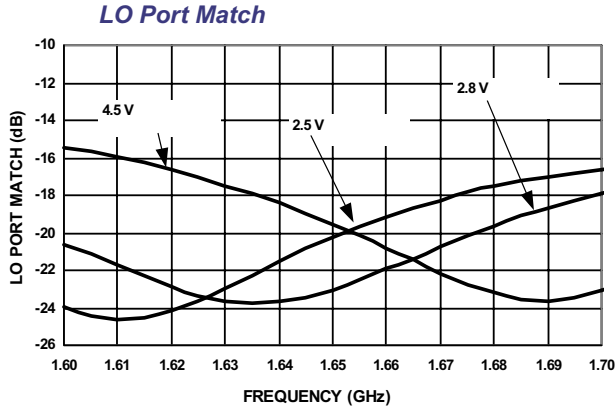

ISM Band

$V_{DD} = 2.8\text{ V}$, $I_{DD} = 7\text{ mA}$, $T_A = 25^\circ\text{ C}$, $RF = 2440\text{ MHz}$, $LO = 2200\text{ MHz}$, $IF = 240\text{ MHz}$ (unless otherwise noted)

Conversion Gain vs. LO Power and Frequency, $I_{DD} = 6.7\text{ mA}$, $RF_{IN} = -27\text{ dBm}$

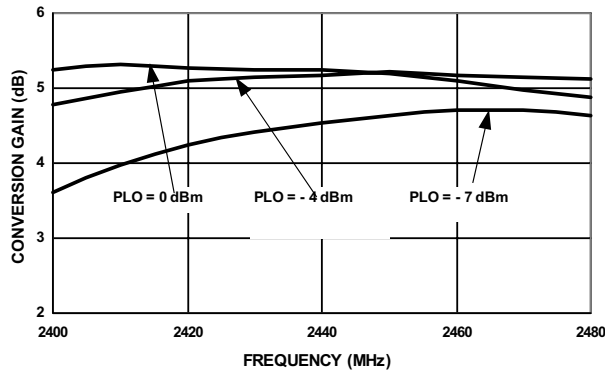

IIP_3 vs. LO Power and Frequency
 $I_{DD} = 6.7\text{ mA}$, $RF_{IN} = -27\text{ dBm}$

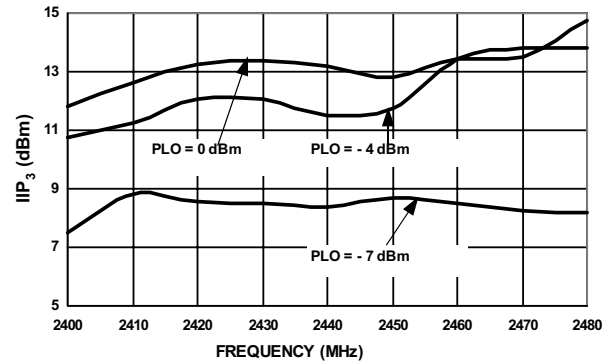

OIP_3 vs. LO Power and Frequency
 $I_{DD} = 6.7\text{ mA}$, $RF_{IN} = -27\text{ dBm}$

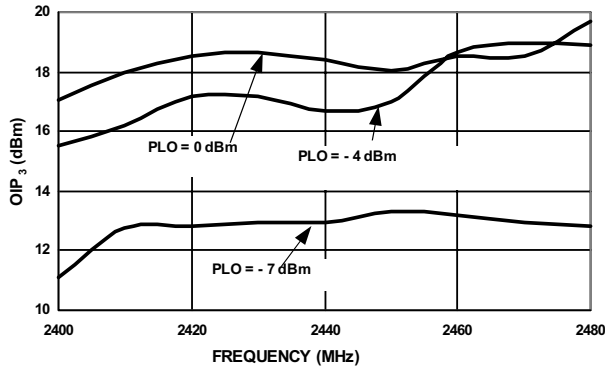

Specifications subject to change without notice.

- North America: Tel. (800) 366-2266, Fax (800) 618-8883
- Asia/Pacific: Tel.+81-44-844-8296, Fax +81-44-844-8298
- Europe: Tel. +44 (1344) 869 595, Fax+44 (1344) 300 020

Visit www.macom.com for additional data sheets and product information.

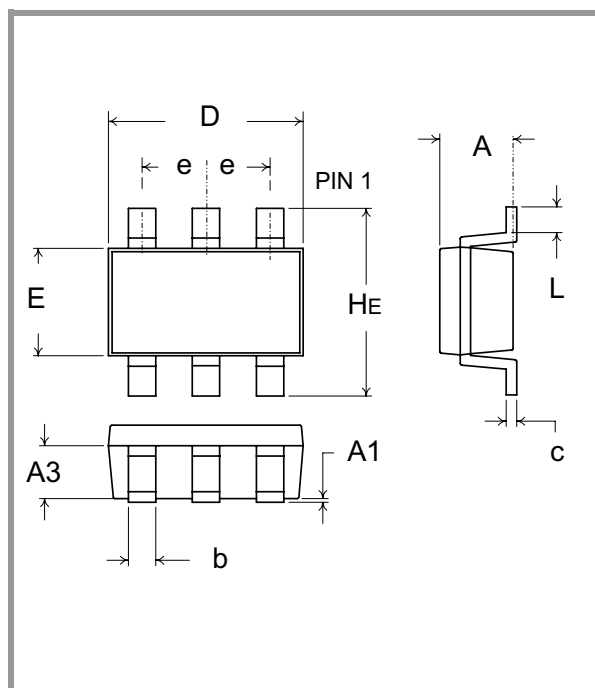

SOT-26¹

¹ See EIAJ ED-7500A, SC-74 for additional dimensional and tolerance information.

Dim	Measurement (mm)		
	Min.	Nom.	Max.
A	0.90	1.10	1.30
A1	0	0.05	0.10
A3	0.62	0.79	1.89
b	0.35	0.40	0.50
c	0.10	0.15	0.25
D	2.70	2.90	3.10
e		0.95	
E	1.50	1.60	1.80
HE	2.6	2.80	3.00
L	0.20	-	-

Ordering Information

Part Number	Package
MD59-0044	SOT-26 Plastic Package
MD59-0044TR	Forward Tape and Reel ¹
MD59-0044RTR	Reverse Tape and Reel ¹

¹ If specific reel size is required, consult factory for part number assignment.

Specifications subject to change without notice.

- North America: Tel. (800) 366-2266, Fax (800) 618-8883
- Asia/Pacific: Tel. +81-44-844-8296, Fax +81-44-844-8298
- Europe: Tel. +44 (1344) 869 595, Fax +44 (1344) 300 020

Visit www.macom.com for additional data sheets and product information.

tyco / Electronics

MACOM