



DESCRIPTION

The S106-X is a bi-directional, single-pole, single-throw, normally open multipurpose relay. The circuit is composed of one LED on the input side which activates an optically coupled IC on the output - controlling the firing angle of two back-to-back SCRs. This circuit assures no false triggering under most adverse conditions, and a tight zero-volt window not exceeding 5V. A 300-ohm input resistor in series with the LED is also provided in this circuit.

FEATURES

- Inverse parallel SCR output
- High transient immunity
- 400V blocking voltage
- 0.8A maximum continuous current
- Low input control current
- High input-to-output isolation
- Solid state reliability
- Zero-volt switching
- 300 ohm input resistor

APPLICATIONS

- Programmable controls
- Valve control
- Solenoids
- Remote switching
- Home appliances
- Metering equipment
- Heating elements
- Gas pump control circuitry

OPTIONS/SUFFIXES

- -H High Output Isolation
- -S Surface Mount Option
- -TR Tape and Reel

MAXIMUM RATINGS

PARAMETER	UNIT	MIN	TYP	MAX
Storage Temperature	°C	-55		125
Operating Temperature	°C	-40		85
Continuous Input Current	mA			40
Transient Input Current	mA			400
Reverse Input Control Voltage	V	6		
Output Power Dissipation	mW			500

SCHEMATIC DIAGRAM

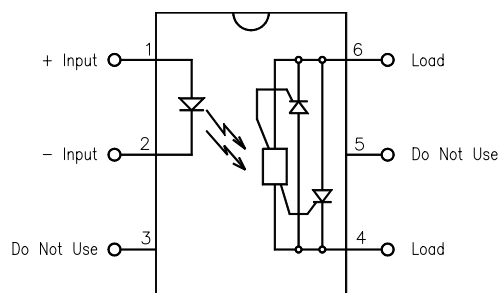

APPROVALS

- BAPT CERTIFICATE #608203:
BS EN 60950, BS EN 41003, BS EN 60065
- UL FILE #E90096

ELECTRICAL CHARACTERISTICS - 25°

PARAMETER	UNIT	MIN	TYP	MAX	TEST CONDITIONS
INPUT SPECIFICATIONS					
LED Forward Voltage	V		1.2	1.5	If = 10mA
LED Reverse Voltage	V	6	12		Ir = 10uA
Input Resistor	Ω		300		
Must Operate Current	m A	5	2.5		Io = 0.8A, resistive load
Junction Capacitance	p F		5		Vf = 0V
OUTPUT SPECIFICATIONS					
Blocking Voltage	V	400			Io = 400uA
Continuous Load Current	A			0.8	If = 5mA
Surge Current Rating	A			5	T = 10us
Holding Current	m A			10	
On-Voltage	V			1.2	Io = 0.8A
Voltage Across Load at Turn-On	V			5	If = 5mA
Leakage Current	μ A		100	250	Vo = 250V
Thermal Resistance	° C /		150		
Power Factor			0.3		
Critical Rate of Rise (dV/dt)	V / μ s	400			
COUPLED SPECIFICATIONS					
Isolation Voltage	V	2500			T = 1 minute
-H Suffix	V	3750			T = 1 minute
Isolation Resistance	G Ω	100			
Coupled Capacitance	p F		6		



PERFORMANCE DATA

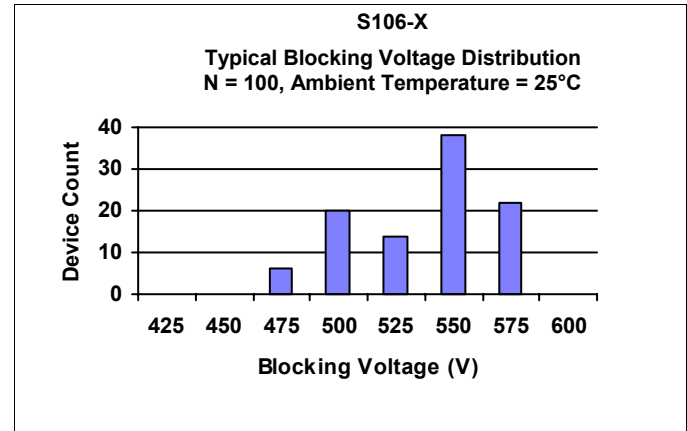
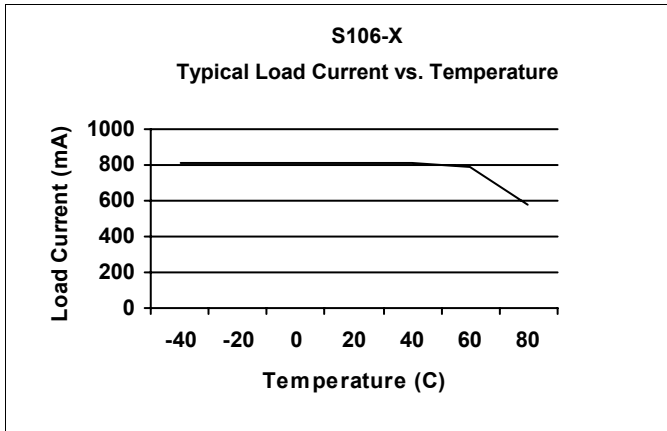

ZERO-VOLT SWITCHING

This solid state relay has been designed with a driver circuit that controls the operation of two back-to-back silicon controlled rectifiers (SCRs), each responsible for one half of the AC cycle. If an AC signal is examined, the turn on, turn off and zero-volt switching can be seen. Figure 1 shows a typical 60 Hz, 120Vac signal with a corresponding relay input signal:

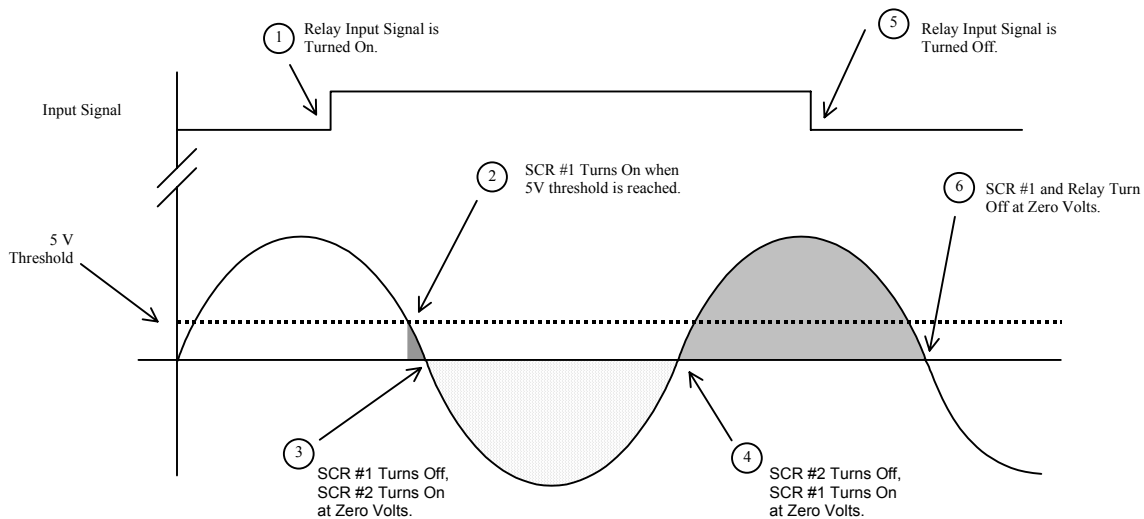

Figure 1 shows the sequence of zero-volt switching operation. At Stage 1, an input signal is applied to the relay. The relay will not turn on until the threshold voltage of 5V is reached. Once this point is reached (Stage 2), SCR #1 (designated as the SCR which controls positive AC voltage) turns on. However, SCR #1 only conducts for an instant, as the cycle quickly crosses zero. At this point (Stage 3), SCR #1 will turn off and SCR #2 (negative AC voltage) turns on. Likewise, at the next zero cross (Stage 4), SCR #2 will turn off and SCR #1 conducts again. Even though the input signal is terminated at Stage 5, the relay will continue to conduct (typical SCR behavior) until Stage 6, when SCR #1 crosses zero and ceases to conduct. Please note that turn on can likewise begin on the negative phase of the AC cycle with a -5V threshold, though only the positive phase is shown here.



1 Form A
Solid State Relay

MECHANICAL DIMENSIONS

6 PIN DUAL IN-LINE PACKAGE

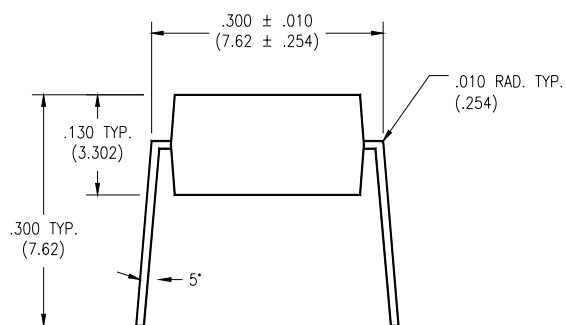

END VIEW

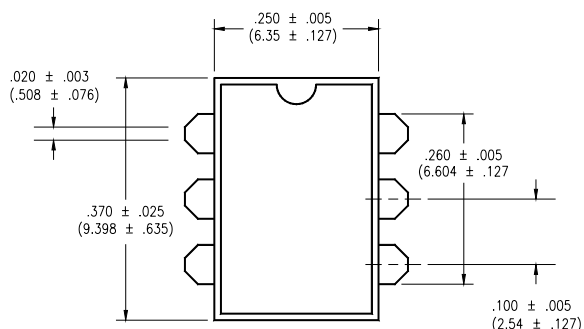

TOP VIEW

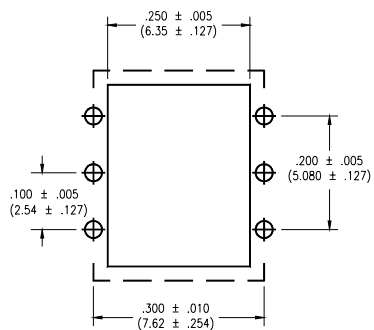

**BOTTOM VIEW/
BOARD PATTERN**

6 PIN SURFACE MOUNT DEVICE

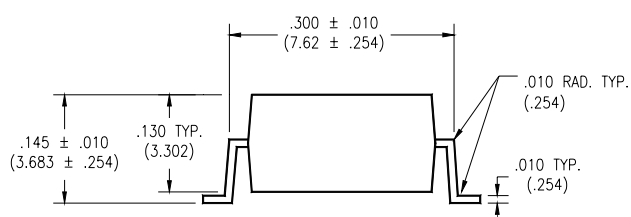

END VIEW

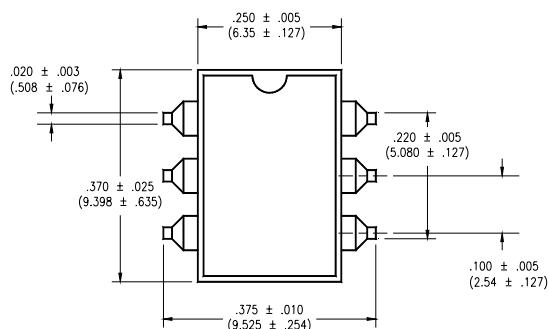

TOP VIEW

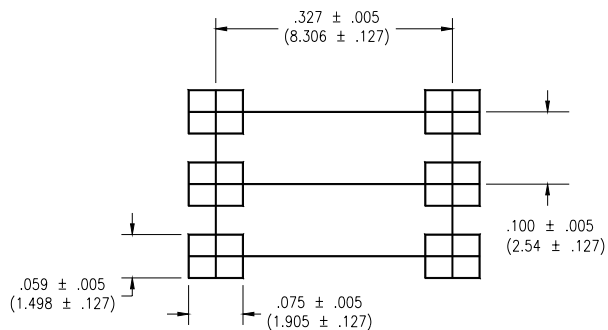

**BOTTOM VIEW/
BOARD PATTERN**