

800mA Low Dropout Positive Voltage Regulator

TO-252



SOT-223



TO-220



Pin Definition:

1. Fixed / Adj
2. Output (tab)
3. Input

SOP-8



Pin Definition:

- | | |
|----------------|-----------|
| 1. Fixed / Adj | 8. N/C |
| 2. Output | 7. Output |
| 3. Output | 6. Output |
| 4. Input | 5. N/C |

General Description

The TS1117B Series are high performance positive voltage regulators are designed for use in applications requiring low dropout performance at full rated current, Additionally, the TS1117B Series provides excellent regulation over variations due to changes in line, load and temperature. Outstanding features include low dropout performance at rated current, fast transient response, internal current limiting and thermal shutdown protection of the output device. The TS1117B Series are three terminal regulators with fixed and adjustable voltage options available in popular packages.

Features

- Low Dropout Performance 1.5V max.
- Full Current Rating Over Line and Temperature
- Fast Transient Response
- ±2% Total Output Regulation Over Line, Load and Temperature
- Adjust Pin Current max 90uA Over Temperature
- Line Regulation Typical 0.015%
- Load Regulation Typical 0.05%
- Fixed / Adjustable Output Voltage
- TO-220, TO-252, SOT-223 and SOP-8 Package

Ordering Information

Part No.	Package	Packing
TS1117BCZxx C0	TO-220	50pcs / Tube
TS1117BCPxx RO	TO-252	2.5Kpcs / 13" Reel
TS1117BCWxx RP	SOT-223	2.5Kpcs / 13" Reel
TS1117BCSxx RL	SOP-8	2.5Kpcs / 13" Reel
TS1117BIPxx RO	TO-252	2.5Kpcs / 13" Reel
TS1117BIWxx RP	SOT-223	2.5Kpcs / 13" Reel
TS1117BISxx RL	SOP-8	2.5Kpcs / 13" Reel

Note: Where **xx** denotes voltage option, available are 5.0V, 3.3V, 2.5V, 1.8V and 1.2V. Leave blank for adjustable version.

Typical Application Circuit

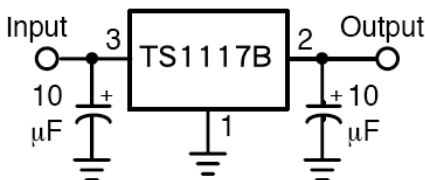

Fixed Output Voltage Version

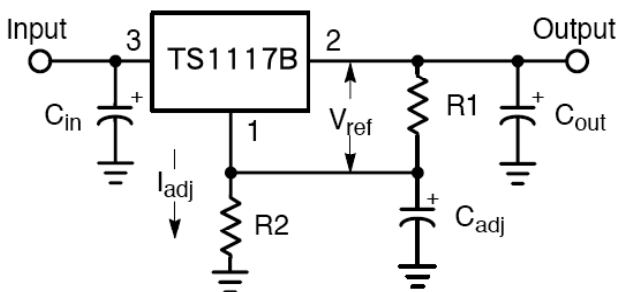

$$V_{out} = V_{ref}(1+R2/R1) + I_{adj} R2$$

Adjustable Output Voltage Version

Block Diagram

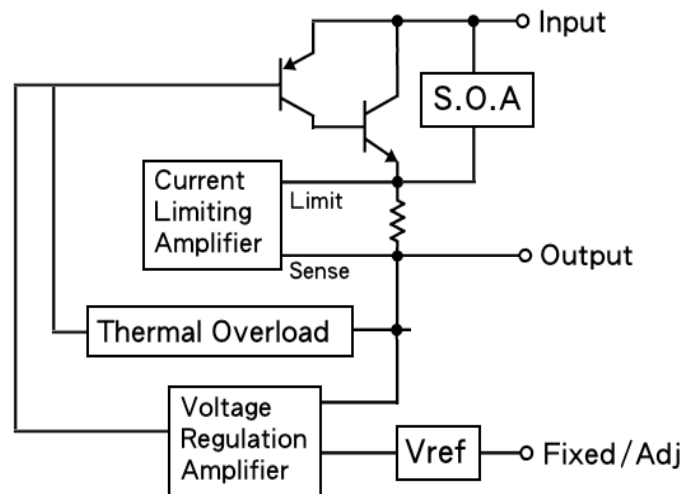

Absolute Maximum Rating (Note 1)

Parameter	Symbol	Limit	Unit
Input Supply Voltage	V_{IN}	15	V
Recommend Operation Input Supply Voltage	V_{IN} (Opr. Typ.)	12	V
Power Dissipation (Note 2)	P_D	Internal limited	
Thermal Resistance Junction to Ambient	TO-220	80	°C/W
	TO-252	105	
	SOT-223	130	
	SOP-8	160	
Operating Temperature Range	TS1117B	0 ~ +125	°C
	TS1117BI	-40 ~ +125	
Junction Temperature Range	T_J	+150	
Storage Temperature Range	T_{STG}	-65 ~ +150	
Lead Soldering Temperature (260 °C)	TO-220	10	S
	TO-252 / SOT-223	5	
	SOP-8	2	

Electrical Specification ($T_a = 25\text{ }^{\circ}\text{C}$, unless otherwise specified.)

Parameter	Conditions	Min	Typ	Max	Unit
Reference Voltage	$V_{in} = 2.75$, $I_o = 800\text{mA}$	1.225	1.25	1.275	V
Output Voltage	$V_{in} = 2.7\text{V} \sim 12\text{V}$, $I_o = 800\text{mA}$	1.176	1.2	1.224	V
	$V_{in} = 3\text{V} \sim 12\text{V}$, $I_o = 800\text{mA}$	1.470	1.5	1.530	V
	$V_{in} = 3.3\text{V} \sim 12\text{V}$, $I_o = 800\text{mA}$	1.764	1.8	1.836	V
	$V_{in} = 4\text{V} \sim 12\text{V}$, $I_o = 800\text{mA}$	2.450	2.5	2.550	V
	$V_{in} = 4.8\text{V} \sim 12\text{V}$, $I_o = 800\text{mA}$	3.235	3.3	3.366	V
	$V_{in} = 6.5\text{V} \sim 12\text{V}$, $I_o = 800\text{mA}$	4.900	5.0	5.100	V
	Line Regulation	$V_o + 1.5\text{V} \leq V_{in} \leq 12\text{V}$, $I_o = 10\text{mA}$	--	0.2	0.5
Load Regulation (Note 1,2)	$V_{in} = V_{out} + 1.5\text{V}$, $I_o = 10\text{mA} \sim 800\text{mA}$	--	0.05	1.0	%
Dropout Voltage	$I_o = 800\text{mA}$, $\Delta V_{out} = 1\% V_{out}$	--	1.3	1.5	V
Quiescent Current	$V_{in} = 5\text{V}$	--	5	10	mA
Adjustable Pin Current		--	90	--	uA
Output Current Limit	$V_{in} - V_{out} = 3\text{V}$	1.1	--	--	A
Temperature Stability	$I_o = 10\text{mA}$,	--	0.5	--	%
Ripple Rejection	$F = 120\text{Hz}$, $I_o = 800\text{mA}$, $C_{out} = 25\mu\text{F}$, $V_{in} = V_{out} + 3\text{V}$	--	60	70	dB

Note 1: See thermal regulation specification for changes in output voltage due to heating effects. Line and load regulation are measured at a constant junction temperature by low duty cycle pulse testing. Load regulation is measured at the output lead = 1/18" from the package.

Note 2: Line and load regulation are guaranteed up to the maximum power dissipation of 15W. Power dissipation is determined by the input / output voltage difference and the output current. Guaranteed maximum power dissipation will not be available over the full input / output voltage range.

Note 3: Quiescent current is defined as the minimum output current required to maintain the regulation.

Electrical Characteristics Curve

FIGURE 1 – Dropout Voltage vs. Output Current

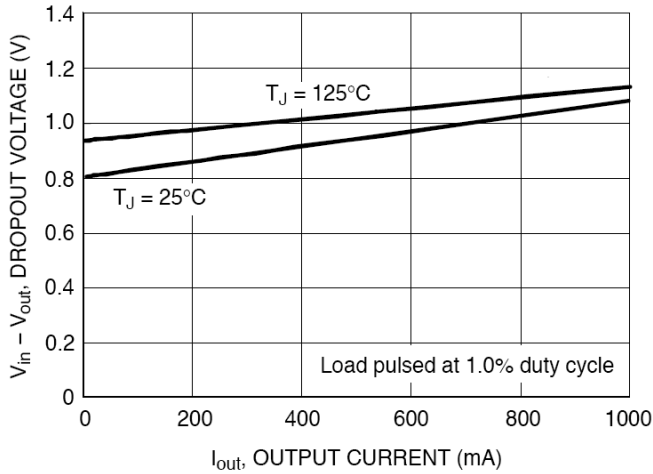

FIGURE 2 – Vout Change vs. Temperature

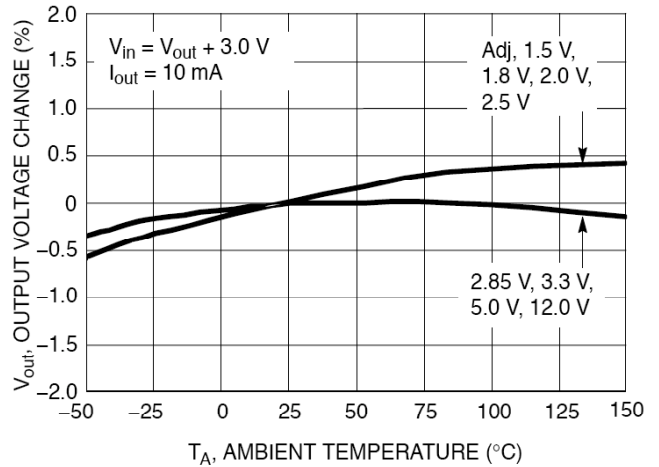

FIGURE 3 – Output Short Circuit Current vs. Differential Voltage

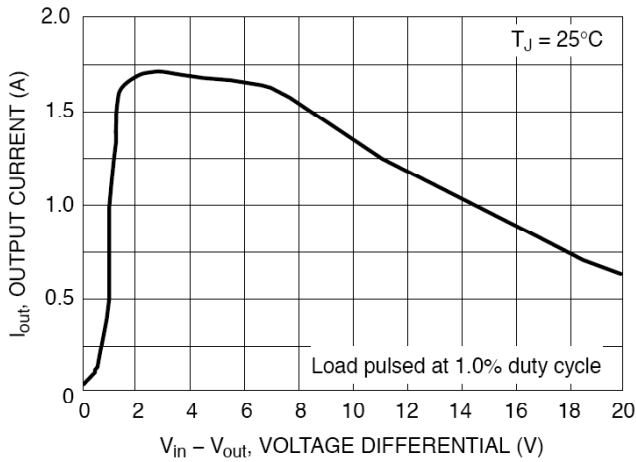

FIGURE 4 – Output Short Circuit Current vs. Temperature

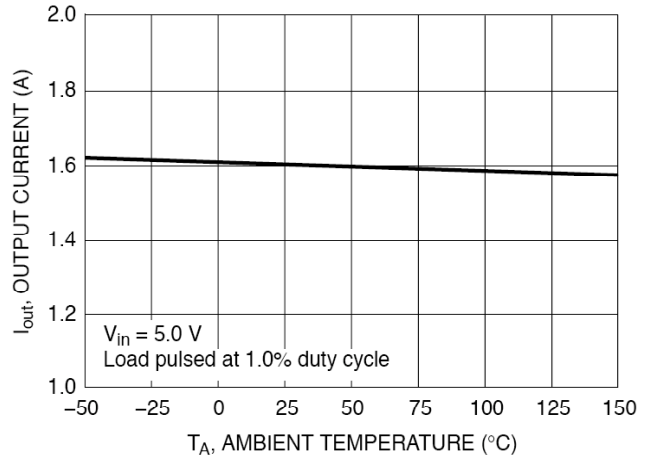

FIGURE 5 – Adjust Pin Current vs. Temperature

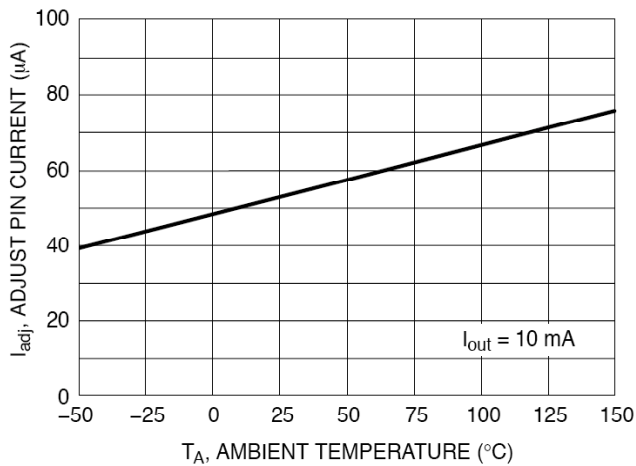
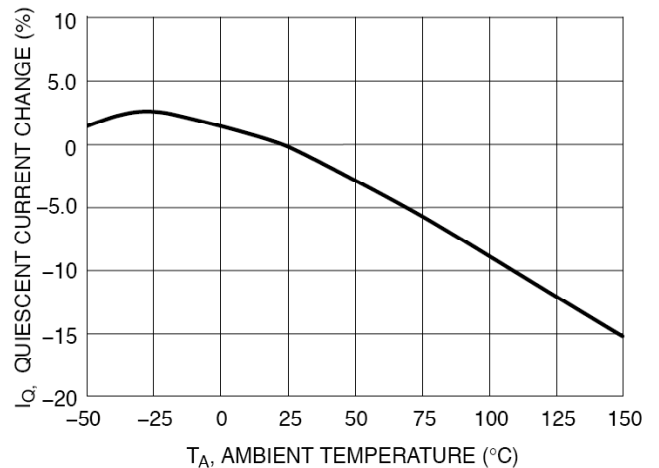

FIGURE 6 – Iq Change vs. Temperature



Application Information

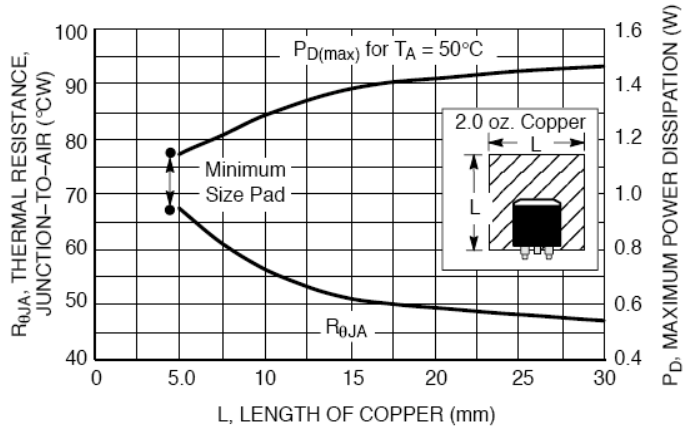

Figure 7 – DPAK Thermal Resistance and Maximum Power Dissipation vs. P.C.B Copper Length

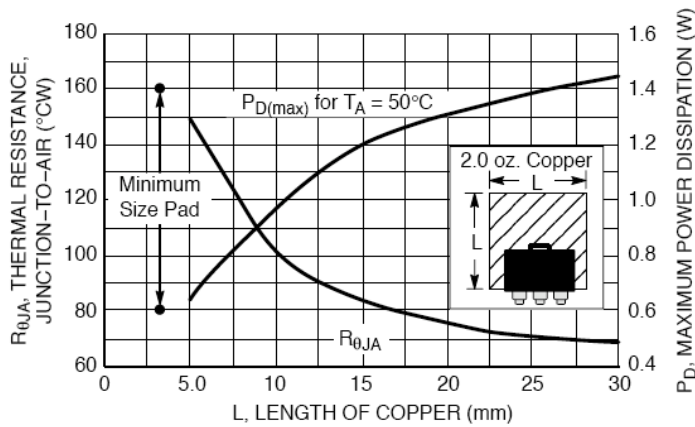
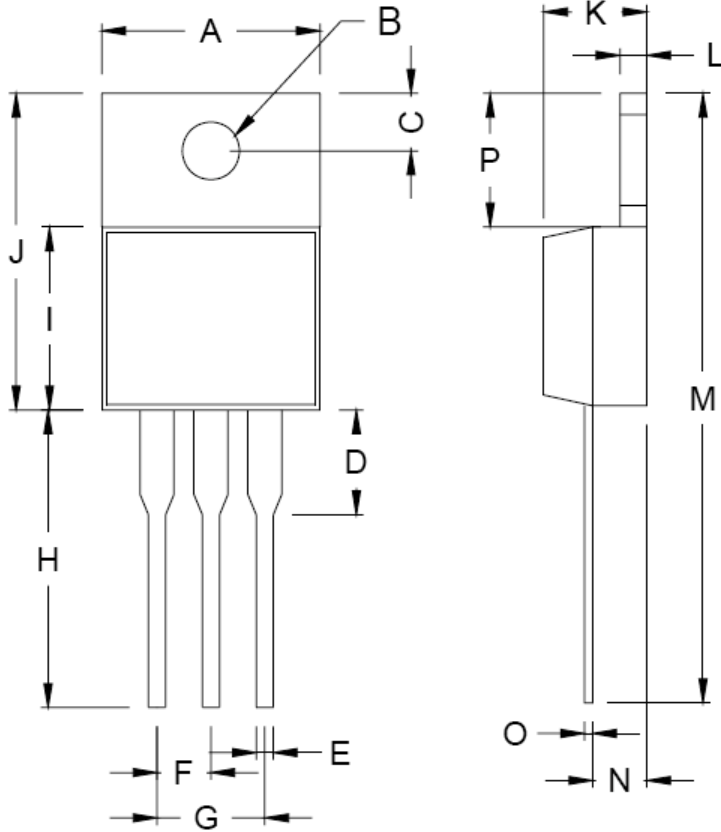

Figure 8 – SOT-223 Thermal Resistance and Maximum Power Dissipation vs. P.C.B Copper Length

TO-220 Mechanical Drawing



TO-220 DIMENSION				
DIM	MILLIMETERS		INCHES	
	MIN	MAX	MIN	MAX
A	10.000	10.500	0.394	0.413
B	3.240	4.440	0.128	0.175
C	2.440	2.940	0.096	0.116
D	-	6.350	-	0.250
E	0.381	1.106	0.015	0.040
F	2.345	2.715	0.092	0.058
G	4.690	5.430	0.092	0.107
H	12.700	14.732	0.500	0.581
I	8.382	9.017	0.330	0.355
J	14.224	16.510	0.560	0.650
K	3.556	4.826	0.140	0.190
L	0.508	1.397	0.020	0.055
M	27.700	29.620	1.060	1.230
N	2.032	2.921	0.080	0.115
O	0.255	0.610	0.010	0.024
P	5.842	6.858	0.230	0.270

TO-252 Mechanical Drawing

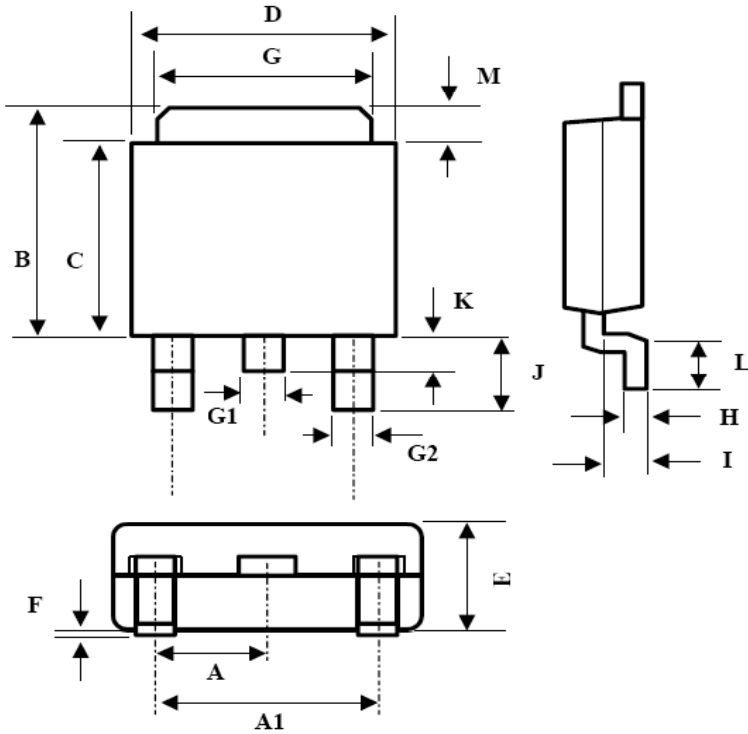

DIM	TO-252 DIMENSION			
	MILLIMETERS		INCHES	
	MIN	MAX	MIN	MAX
A	2.3BSC		0.09BSC	
A1	4.6BSC		0.18BSC	
B	6.80	7.20	0.268	0.283
C	5.40	5.60	0.213	0.220
D	6.40	6.65	0.252	0.262
E	2.20	2.40	0.087	0.094
F	0.00	0.20	0.000	0.008
G	5.20	5.40	0.205	0.213
G1	0.75	0.85	0.030	0.033
G2	0.55	0.65	0.022	0.026
H	0.35	0.65	0.014	0.026
I	0.90	1.50	0.035	0.059
J	2.20	2.80	0.087	0.110
K	0.50	1.10	0.020	0.043
L	0.90	1.50	0.035	0.059
M	1.30	1.70	0.051	0.67

SOT-223 Mechanical Drawing

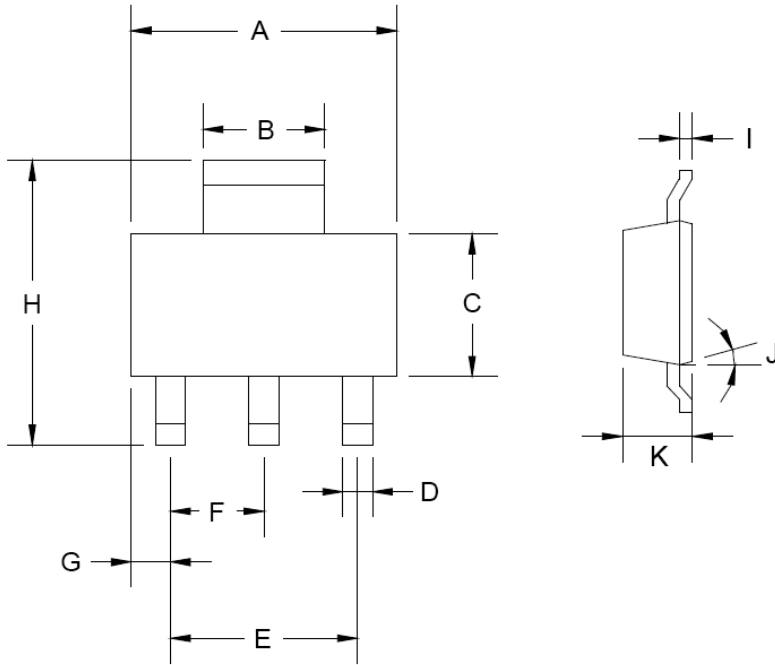

SOT-223 DIMENSION				
DIM	MILLIMETERS		INCHES	
	MIN	MAX	MIN	MAX
A	6.350	6.850	0.250	0.270
B	2.900	3.100	0.114	0.122
C	3.450	3.750	0.136	0.148
D	0.595	0.635	0.023	0.025
E	4.550	4.650	0.179	0.183
F	2.250	2.350	0.088	0.093
G	0.835	1.035	0.032	0.041
H	6.700	7.300	0.263	0.287
I	0.250	0.355	0.010	0.014
J	10°	16°	10°	16°
K	1.550	1.800	0.061	0.071

SOP-8 Mechanical Drawing

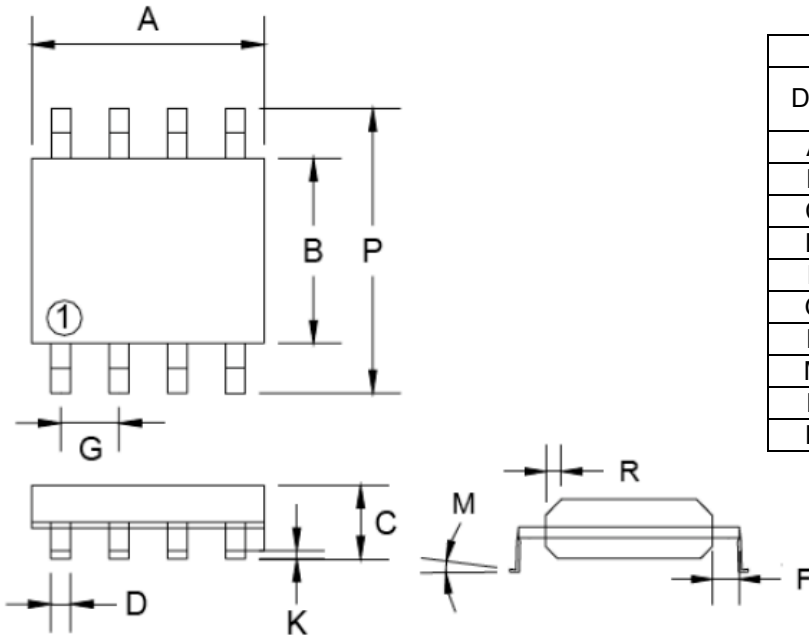

SOP-8 DIMENSION				
DIM	MILLIMETERS		INCHES	
	MIN	MAX	MIN	MAX.
A	4.80	5.00	0.189	0.196
B	3.80	4.00	0.150	0.157
C	1.35	1.75	0.054	0.068
D	0.35	0.49	0.014	0.019
F	0.40	1.25	0.016	0.049
G	1.27BSC		0.05BSC	
K	0.10	0.25	0.004	0.009
M	0°	7°	0°	7°
P	5.80	6.20	0.229	0.244
R	0.25	0.50	0.010	0.019

Notice

Specifications of the products displayed herein are subject to change without notice. TSC or anyone on its behalf, assumes no responsibility or liability for any errors or inaccuracies.

Information contained herein is intended to provide a product description only. No license, express or implied, to any intellectual property rights is granted by this document. Except as provided in TSC's terms and conditions of sale for such products, TSC assumes no liability whatsoever, and disclaims any express or implied warranty, relating to sale and/or use of TSC products including liability or warranties relating to fitness for a particular purpose, merchantability, or infringement of any patent, copyright, or other intellectual property right.

The products shown herein are not designed for use in medical, life-saving, or life-sustaining applications. Customers using or selling these products for use in such applications do so at their own risk and agree to fully indemnify TSC for any damages resulting from such improper use or sale.