

SINGLE SUPPLY QUAD OPERATIONAL AMPLIFIER

■ GENERAL DESCRIPTION

The **NJM13403** is single-supply quad operational amplifier, which can operate from 2V supply. The features are low offset voltage, low bias current, high slew-rate, free cross-over distortion through the AB class output stage.

The package lineup is DIP, DMP and others compact, which is SON, so that the **NJM13403** is suitable for audio for low voltage operation and any other kind of signal amplifier.

■ PACKAGE OUTLINE

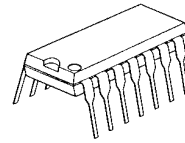

NJM13403D1

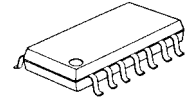

NJM13403M

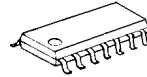

NJM13403E

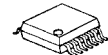

NJM13403V

■ FEATURES

- Operating Voltage (+2V to 14V)
- Slew Rate (1.2V/μs typ.)
- Operating Current (3.0mA typ.)
- Bipolar Technology
- Package Outline DIP14,DMP14,EMP14,SSOP14

■ PIN CONFIGURATION

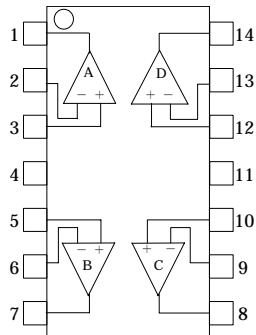

NJM13403D1/13403M
NJM13403E/13403V

PIN FUNCTION

- | | |
|-------------------|--------------|
| 1. A OUTPUT | 8. C OUTPUT |
| 2. A -INPUT | 9. C -INPUT |
| 3. A +INPUT | 10. C +INPUT |
| 4. V ⁺ | 11. GND |
| 5. B +INPUT | 12. D +INPUT |
| 6. B -INPUT | 13. D -INPUT |
| 7. B OUTPUT | 14. D OUTPUT |

■ EQUIVALENT CIRCUIT (1/4Shown)

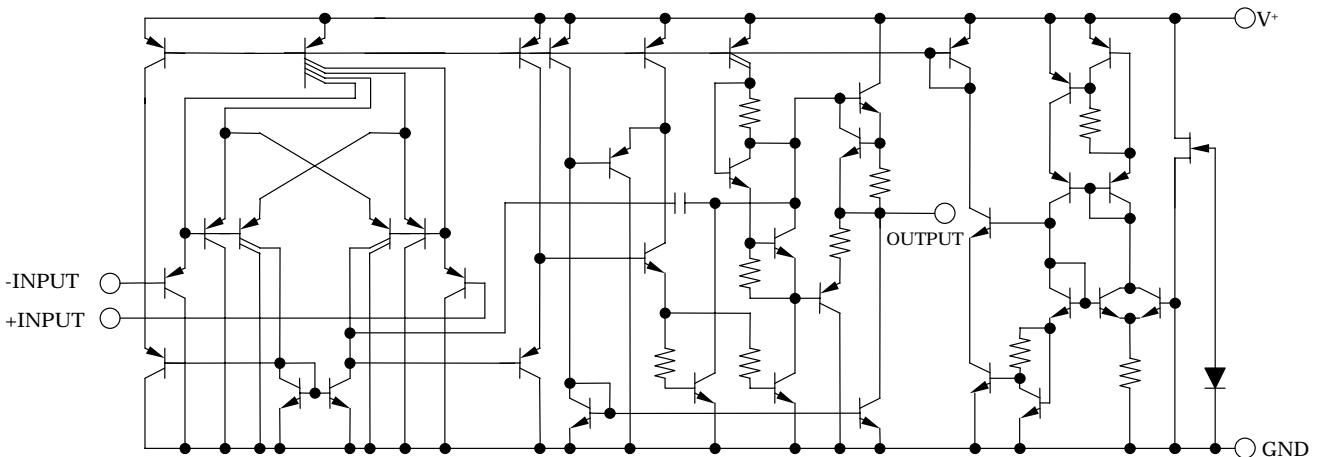

■ ABSOLUTE MAXIMUM RATINGS

(Ta=25°C)

PARAMETER	SYMBOL	RATINGS	UNIT
Supply Voltage	V ⁺	15	V
Differential Input Voltage	V _{ID}	14	V
Input Voltage	V _{IC}	- 0.3 to +14	V
Power Dissipation	P _D	(DIP8) 700 (DMP8) 300 (EMP8) 300 (SSOP8) 300	mW
Operating Temperature Range	T _{opr}	- 40 to +85	°C
Storage Temperature Range	T _{stg}	- 40 to +125	°C

■ ELECTRICAL CHARACTERISTICS (V⁺=5V, Ta=25°C)

PARAMETER	SYMBOL	TEST CONDITION	MIN.	TYP.	MAX.	UNIT
Operating Voltage	V _{opr}		2	-	14	V
Input Offset Voltage	V _{IO}	R _S =0Ω	-	0.5	4	mV
Input Offset Current	I _{IO}		-	5	50	nA
Input Bias Current	I _B		-	25	150	nA
Large Signal Voltage Gain	A _V	R _L ≥2kΩ	88	100	-	dB
Maximum Output Voltage Swing	V _{OM}	R _L =2kΩ	4.0	4.2	-	V
Input Common Mode Voltage Range	V _{ICM}		0 to 3.5	-	-	V
Common Mode Rejection Ratio	CMR		70	90	-	dB
Supply Voltage Rejection Ratio	SVR		80	94	-	dB
Output Source Current	I _{SOURCE}	V _{IN} ⁺ =1V, V _{IN} ⁻ =0V	20	35	-	mA
Output Sink Current	I _{SINK}	V _{IN} ⁺ =0V, V _{IN} ⁻ =1V	10	30	-	mA
Operating Current	I _{CC}	R _L =∞	-	3.0	5.0	mA
Slew Rate	SR	V ⁺ /V ⁻ =±2.5V, R _L =2kΩ, A _V =0dB, f=1kHz	-	1.2	-	V/μs
Unity Gain Bandwidth	f _T	R _L =2kΩ	-	2.0	-	MHz
Total Harmonic Distortion	THD	R _L =2kΩ, A _V =40dB, f=20kHz, V _O =1.0Vrms	-	0.2	-	%

NJM13403 Operating Current vs. Operating Voltage

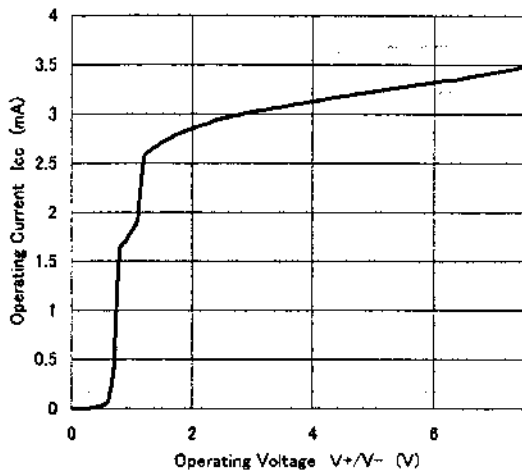

NJM13403 Input Offset Voltage vs. Operating Voltage

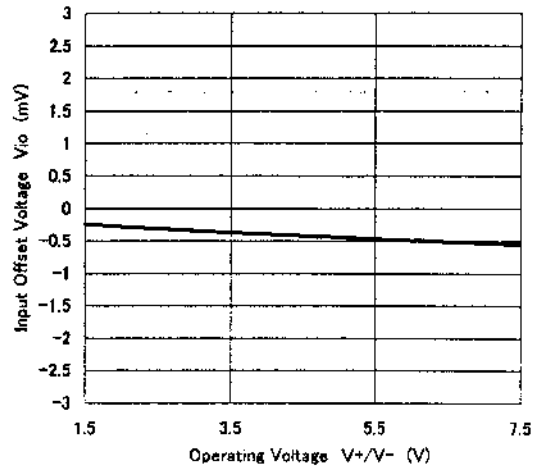

NJM13403 Input Bias Current vs. Operating Voltage

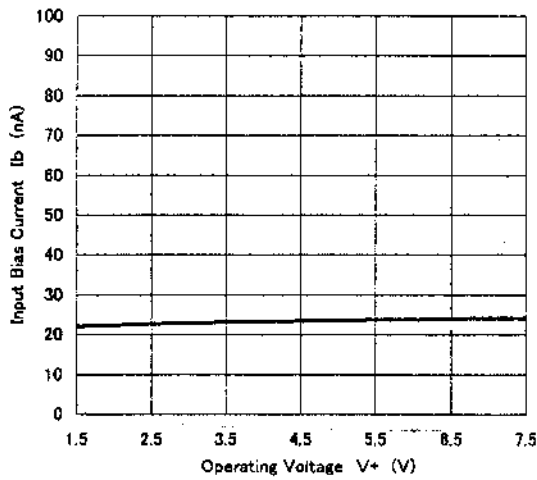

NJM13403 Maximum Output Voltage Swing vs. Operating Voltage

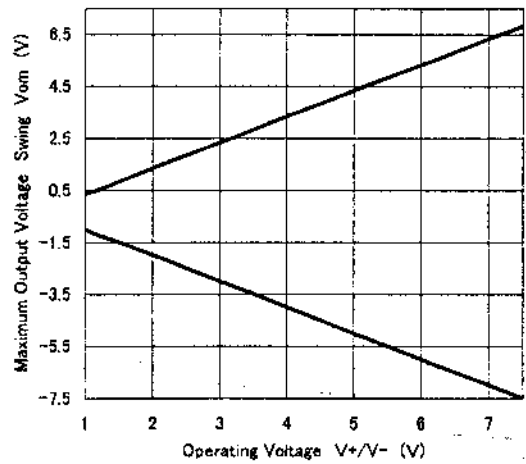

NJM13403 Input CommonMode Voltage Range

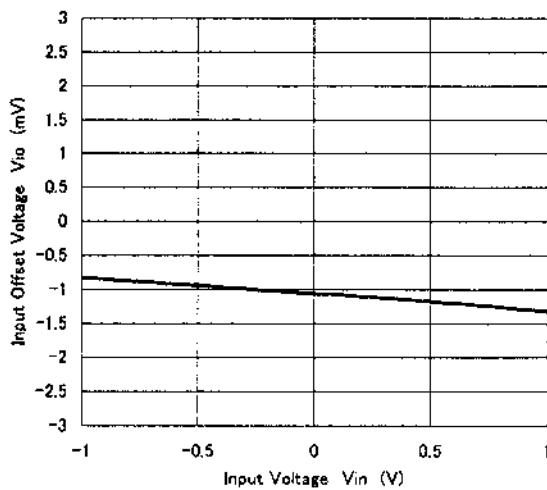

NJM13403 Large Signal Voltage Gain vs. Operating Voltage

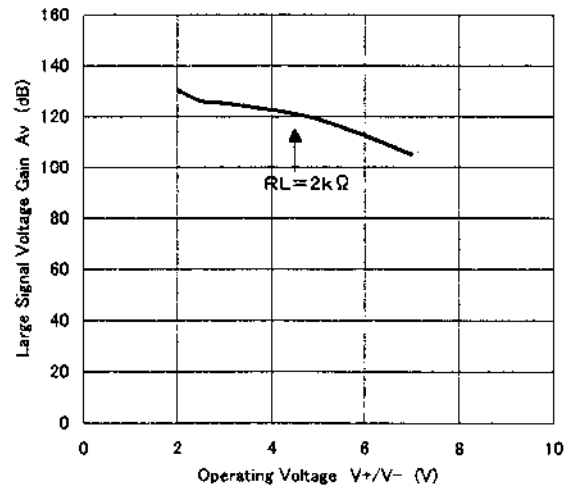

NJM13403

NJM13403 Maximum Output Voltage Swing vs Frequency

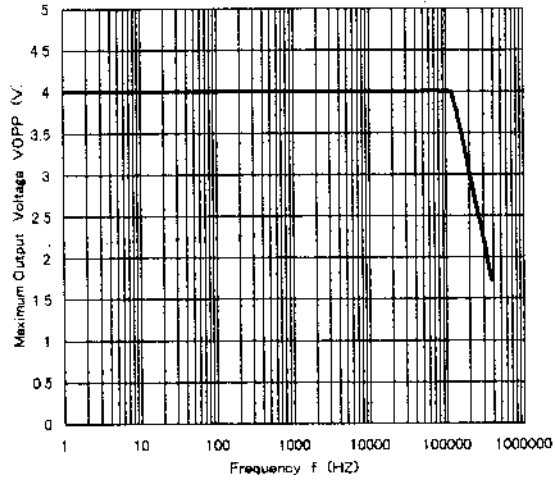

NJM13403 Open Loop Voltage Gain vs Frequency

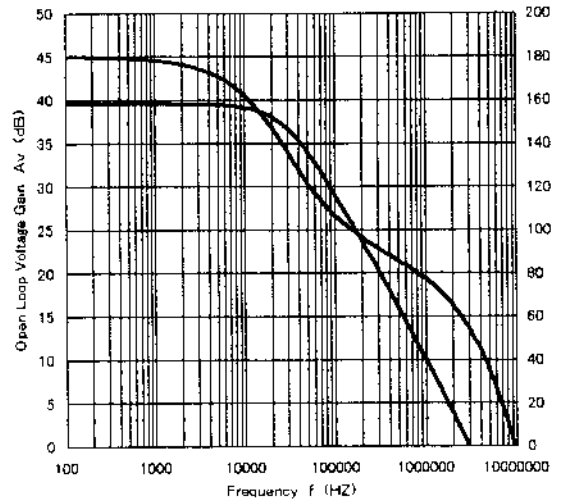

NJM13403 Output Voltage vs. Output Sink Current

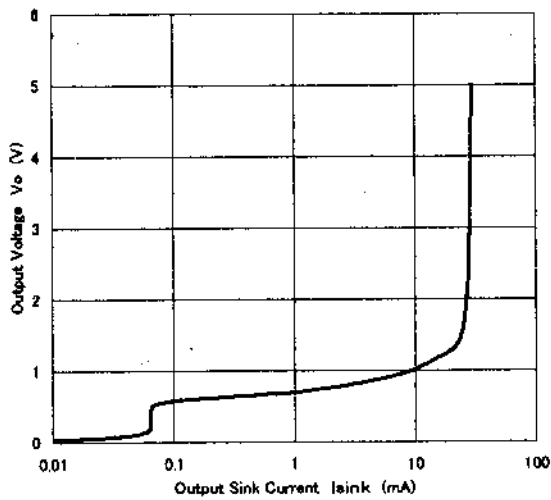

NJM13403 Output Voltage vs. Output Source Current

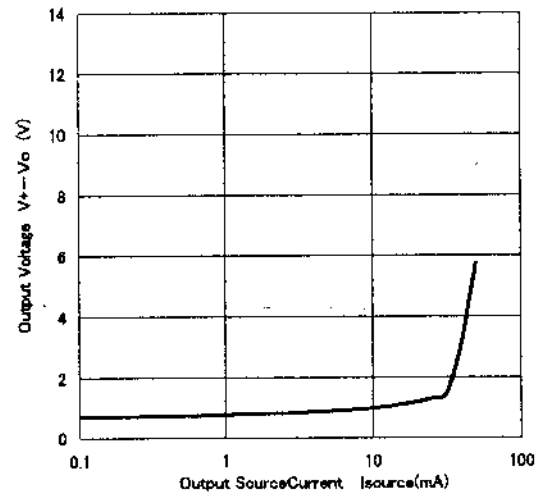

NJM13403 Maximum Output Voltage vs Load Resistance

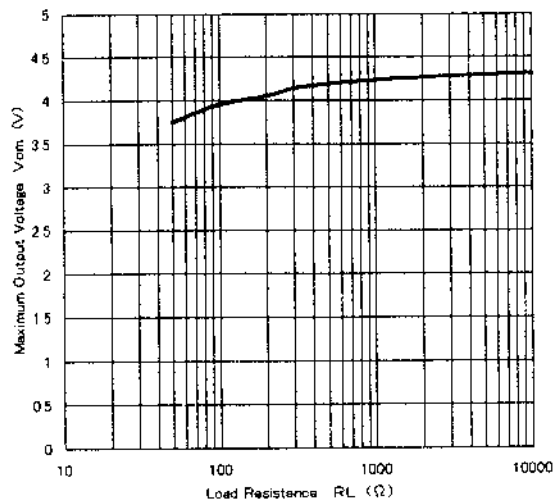

NJM13403 Slew Rate (Rise)

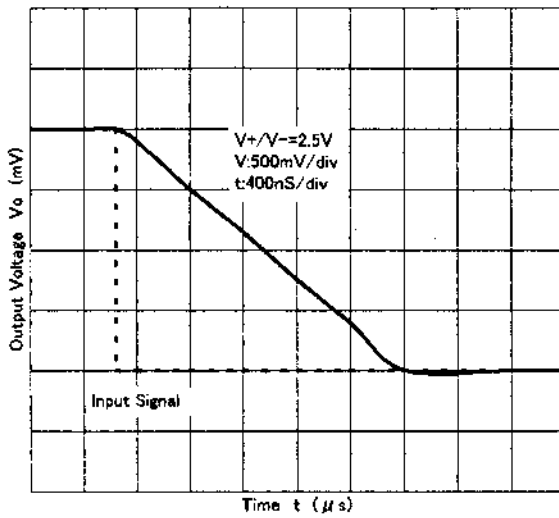

NJM13403 Slew Rate (Fall)

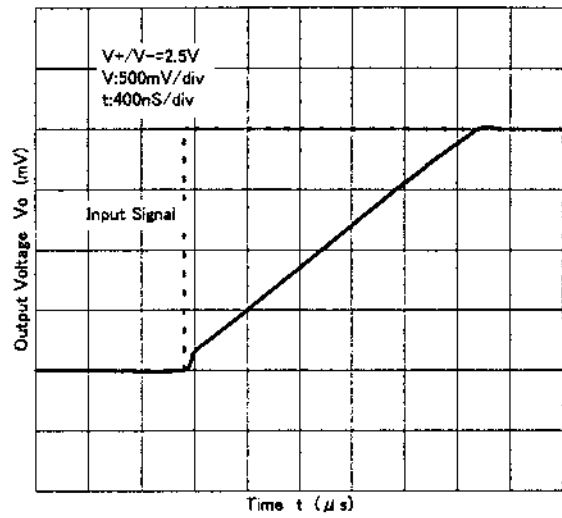

NJM13403 Total Harmonic Distortion

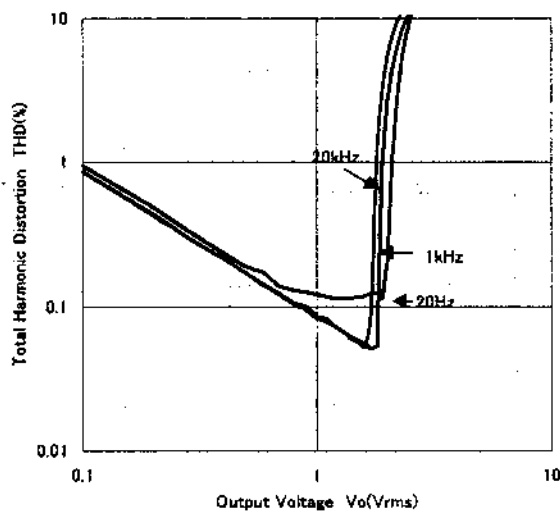

NJM13403 Equivalent Noise Voltage vs. Frequency

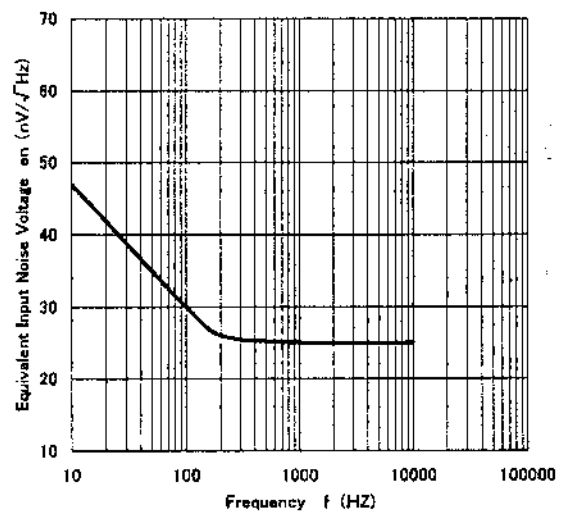

NJM13403

NJM13403 Operating Voltage vs. Temperature

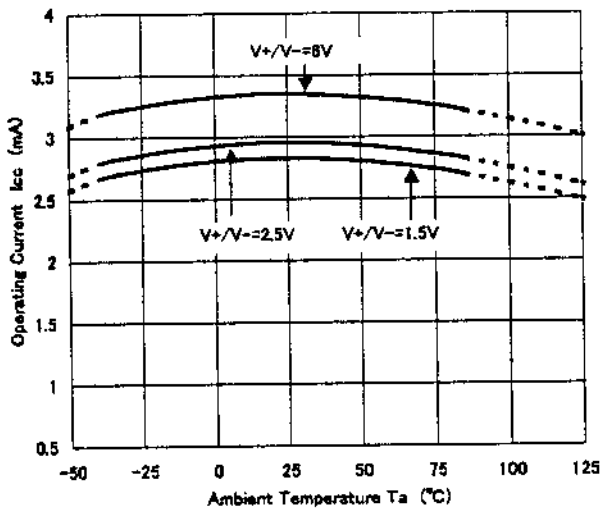

NJM13403 Input Offset Voltage vs. Temperature

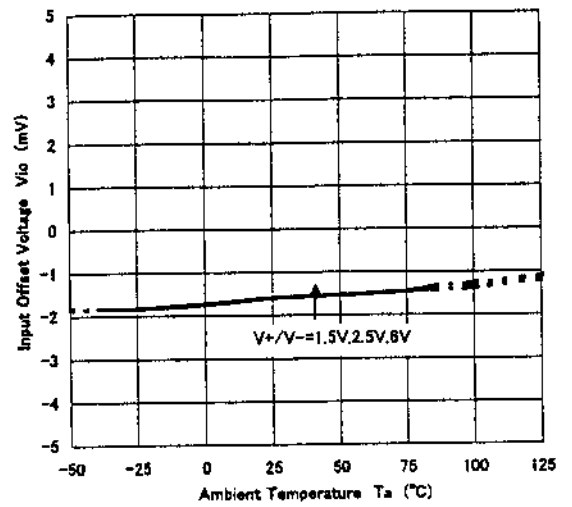

NJM13403 Input Bias Current vs. Temperature

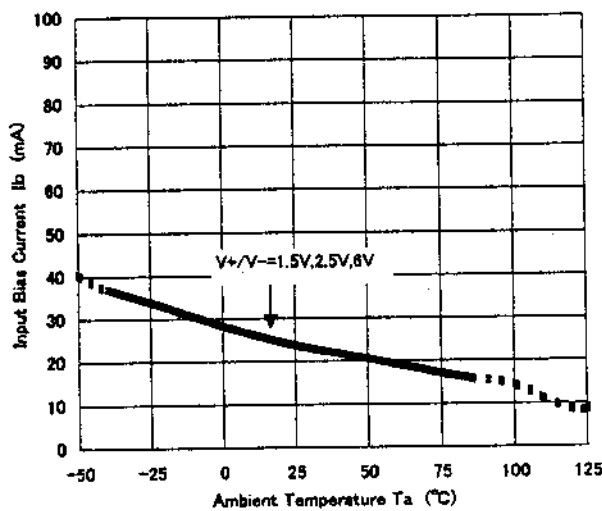

NJM13403 Maximum Output Voltage Swing vs. Temperature

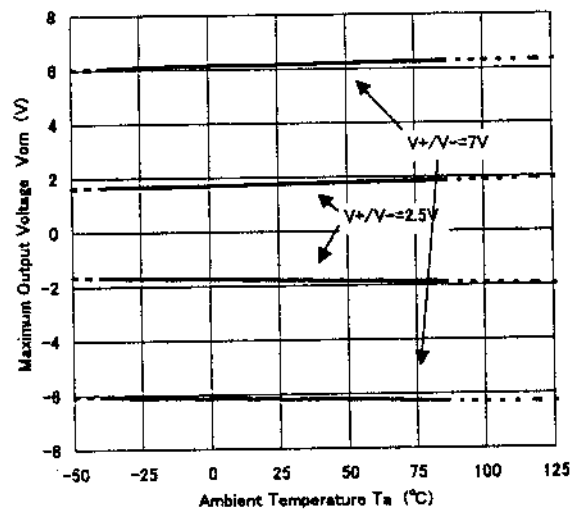

NJM13404 Output Sink Current vs. Temperature

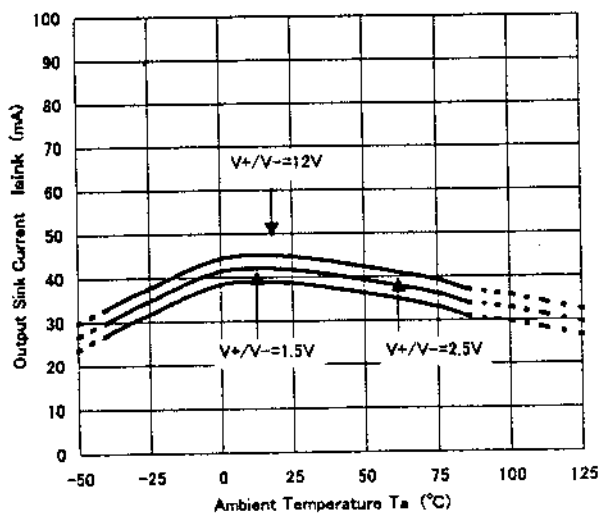

NJM13404 Output Source Current vs. Temperature

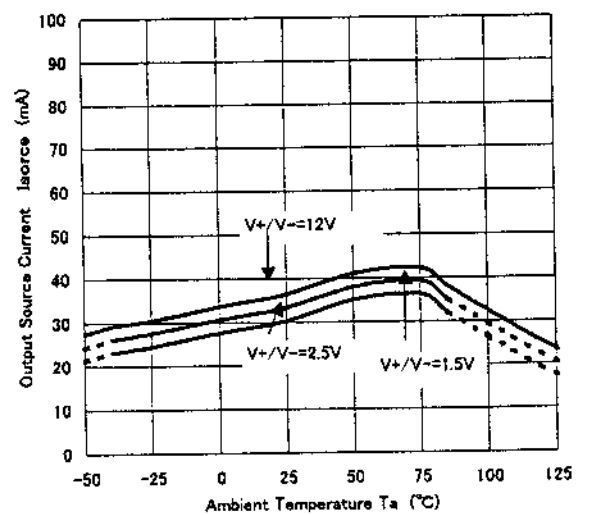

NJM13403 Open Loop Voltage Gain vs. Temperature

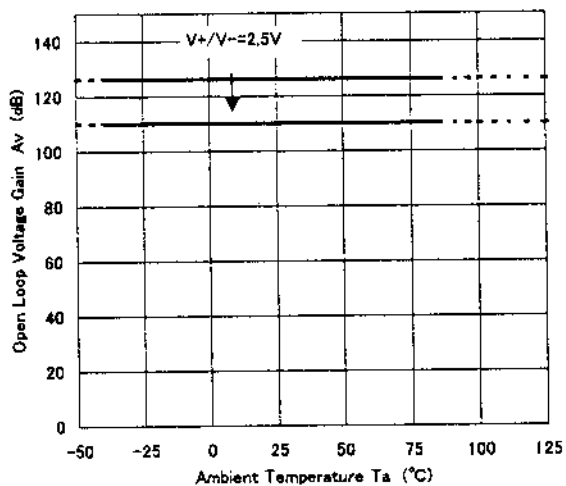

NJM13403 Common Mode Rejection Ratio vs. Temperature

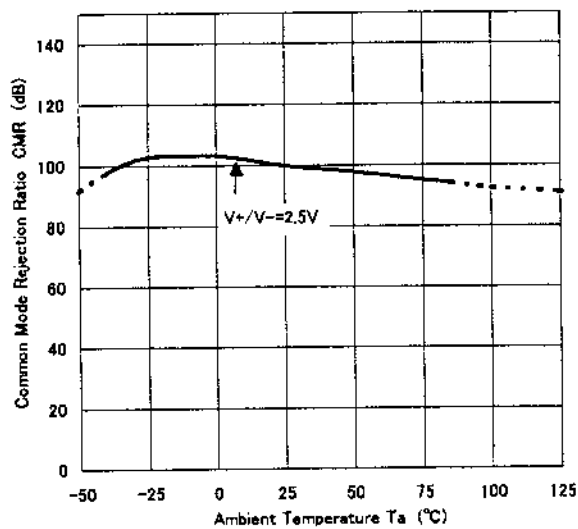

NJM13403 Supply Voltage Rejection Ratio vs. Temperature

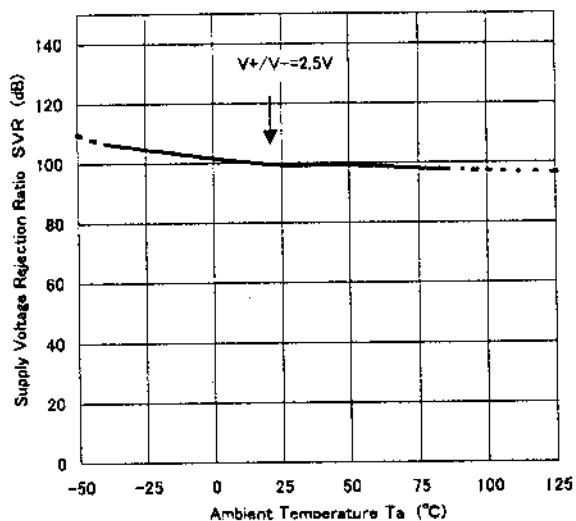

MEMO

[CAUTION]
The specifications on this databook are only given for information, without any guarantee as regards either mistakes or omissions. The application circuits in this databook are described only to show representative usages of the product and not intended for the guarantee or permission of any right including the industrial rights.