

J-FET INPUT OPERATIONAL AMPLIFIER

■ GENERAL DESCRIPTION

The NJM062/064 are J-FET input operational amplifiers which were designed as low-power versions of the NJM082. They feature high input impedance, wide bandwidth, high slew rate, and low input offset and bias current. The NJM062 features the same terminal assignments as the NJM4558/2043/2904/3404/072 and NJM064 features the same terminal assignments as the NJM2902/3403/2058/2059/2060. Each of these JFET-input operational amplifiers incorporates well-matched, high voltage JFET and bipolar transistors in a monolithic integrated circuit.

■ FEATURES

- Operating Voltage (±2V ~ ±18V)
- J-FET Input
- High Input Resistance (10¹²Ω typ.)
- Low Operating Current (200 μA/circuit typ.)
- High Slew Rate (3.5V/μs typ.)
- Wide Unity Gain Bandwidth (1MHz typ.)
- Package Outline DIP8/14, DMP8/14, SSOP8/14, SIP8
- Bipolar Technology

■ PACKAGE OUTLINE

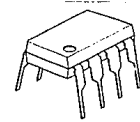

NJM062D



NJM062M

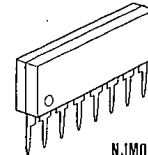

NJM062L



NJM062V

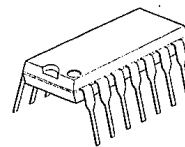

NJM064D

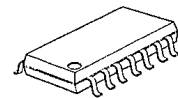

NJM064M

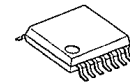

NJM064V

4

■ PIN CONFIGURATION

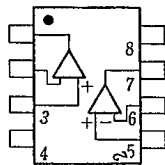

NJM062D
NJM062M
NJM062V

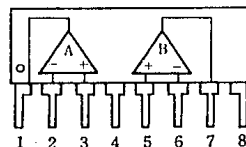

NJM062L

- PIN FUNCTION
1. A OUTPUT
 2. A-INPUT
 3. A+INPUT
 4. V-
 5. B+INPUT
 6. B-INPUT
 7. B OUTPUT
 8. V+

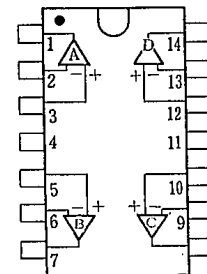

NJM064D
NJM064M
NJM064V

- PIN FUNCTION
1. A OUTPUT
 2. A-INPUT
 3. A+INPUT
 4. V+
 5. B+INPUT
 6. B-INPUT
 7. B OUTPUT
 8. C OUTPUT
 9. C-INPUT
 10. C+INPUT
 11. V-
 12. D+INPUT
 13. D-INPUT
 14. D OUTPUT

■ EQUIVALENT CIRCUIT

(062 is 1/2 Shown. 064 is 1/4 Shown)

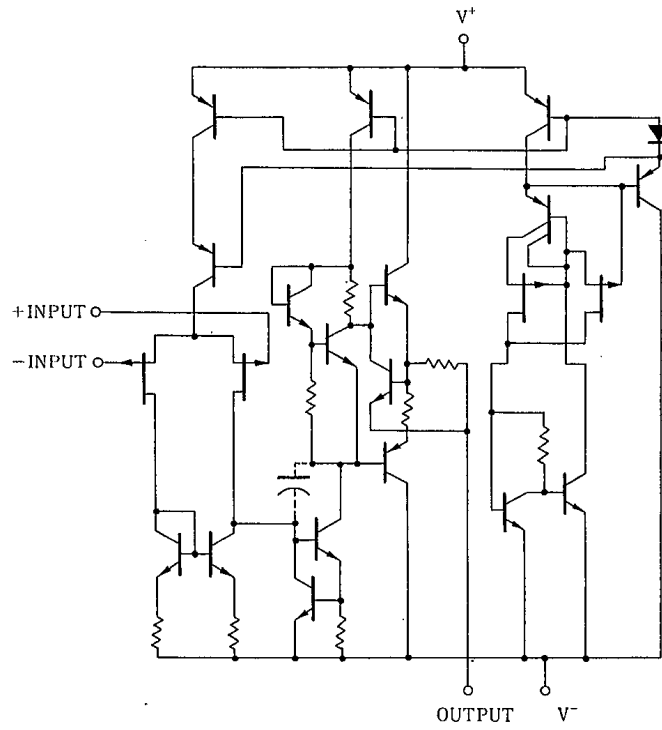

4

■ ABSOLUTE MAXIMUM RATINGS

(Ta=25°C)

| PARAMETER | SYMBOL | RATINGS | UNIT |
|-----------------------------|--------------------------------|----------------------|------|
| Supply Voltage | V ⁺ /V ⁻ | ±18 | V |
| Differential Input Voltage | V _{ID} | ±30 | V |
| Input Voltage | V _{IC} | ±15 | V |
| Power Dissipation | P _D | (DIP8) 500 | mW |
| | | (DMP8) 300 | mW |
| | | (SIP8) 800 | mW |
| | | (SSOP8) 250 | mW |
| | | (DIP14) 700 | mW |
| | | (DMP14) 700 (note 2) | mW |
| | (SSOP14) 300 | mW | |
| Operating Temperature Range | T _{opr} | -40~+85 | °C |
| Storage Temperature Range | T _{stg} | -40~+125 | °C |

(note 1) For supply voltage less than ±15V, the absolute maximum input voltage is equal to the supply voltage.
 (note 2) at on PC board

4

■ ELECTRICAL CHARACTERISTICS (V⁺/V⁻=±15V, Ta=25°C)

| PARAMETER | SYMBOL | TEST CONDITION | MIN. | TYP. | MAX. | UNIT |
|---|--------------------------------|--|------|------------------|------|--------|
| Operating Supply Voltage | V ⁺ /V ⁻ | | ±2 | — | ±18 | V |
| Input Offset Voltage | V _{IO} | R _S = 50Ω | — | 3 | 15 | mV |
| Input Offset Current | I _{IO} | | — | 1 | 200 | pA |
| Input Bias Current | I _B | | — | 2 | 400 | pA |
| Input Common Mode voltage Range | V _{ICM} | | ±13 | +15 -13.5 | — | V |
| Maximum Peak-to-peak Output Voltage Swing | V _{OM} | R _L = 10kΩ | ±13 | +14.2 -14.0 | — | V |
| Large-signal Voltage Gain | A _V | R _L ≥ 10kΩ, V _O = ±10V | 70 | 80 | — | dB |
| Unity Gain Bandwidth | f _T | R _L = 10kΩ | — | 1 | — | MHz |
| Input Resistance | R _{IN} | | — | 10 ¹² | — | Ω |
| Common Mode Rejection Ratio | CMR | R _S ≤ 10kΩ | 70 | 90 | — | dB |
| Supply voltage Rejection Ratio | SVR | R _S ≤ 10kΩ | 70 | 100 | — | dB |
| Operating Current | I _{CC} | R _L = ∞ each amplifier | — | 200 | 250 | μA |
| Slew Rate | SR | R _L = 10kΩ | — | 3.5 | — | V/μs |
| Equivalent Input Noise Voltage | e _n | R _S = 100Ω, f = 1kHz | — | 35 | — | nV/√Hz |

■ TYPICAL CHARACTERISTICS

Voltage Gain, Phase Shift vs. Frequency

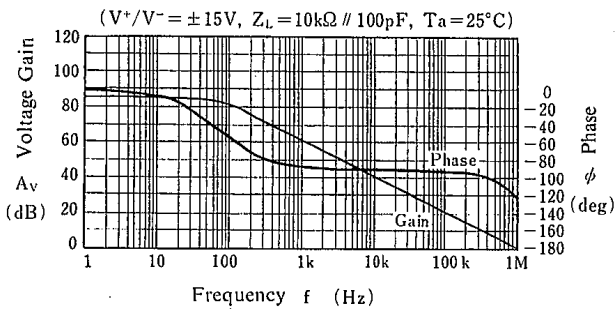

Maximum Output Voltage Swing vs. Frequency

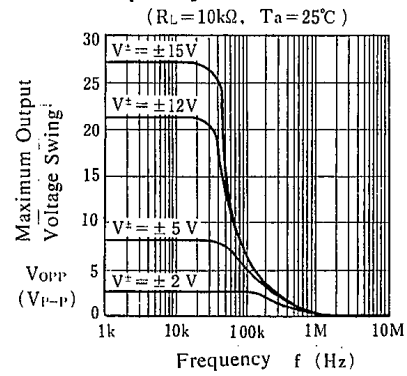

Maximum Output Voltage Swing vs. Load Resistance

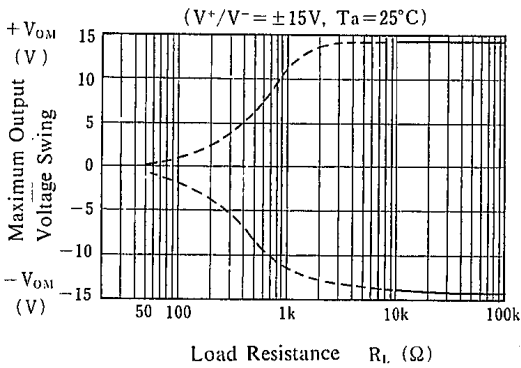

Maximum Output Voltage Swing vs. Output Current

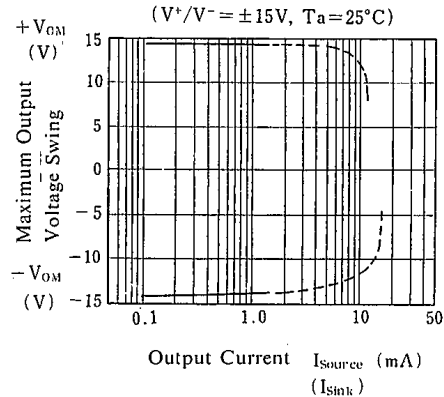

Equivalent Input Noise Voltage vs. Frequency

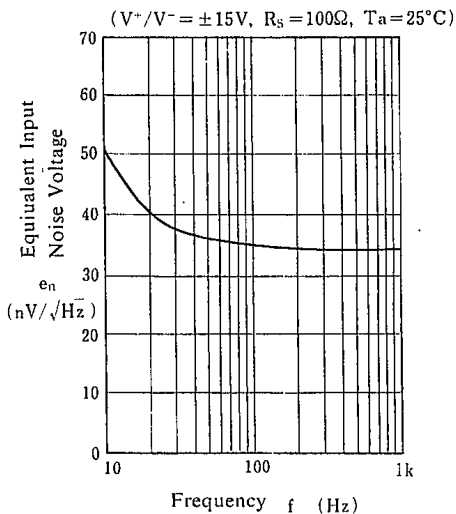

Voltage Follower Large Signal Pulse Response

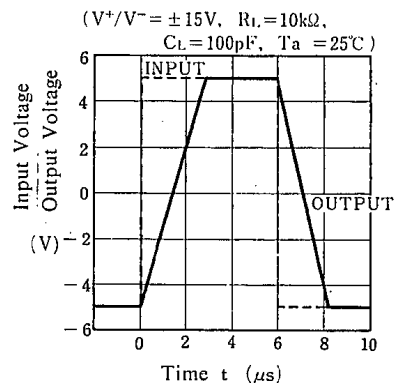

4

TYPICAL CHARACTERISTICS

Operating Current vs. Temperature

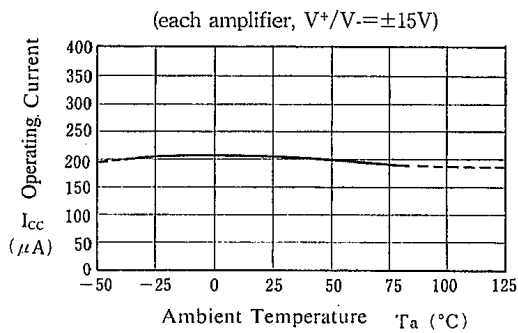

Maximum Output Voltage Swing vs. Temperature

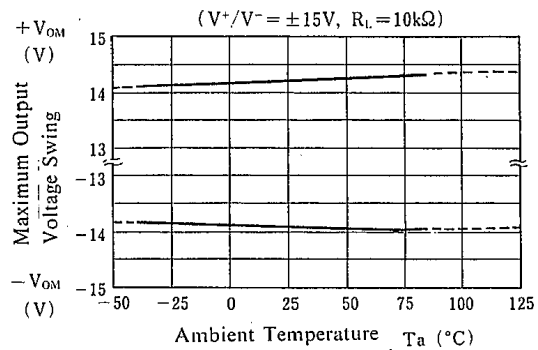

4

Input Offset Voltage vs. Temperature

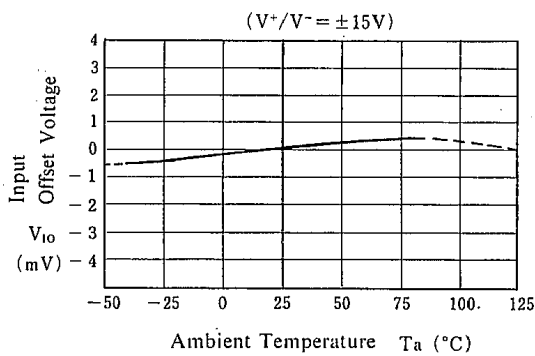

Input Bias Current vs. Temperature

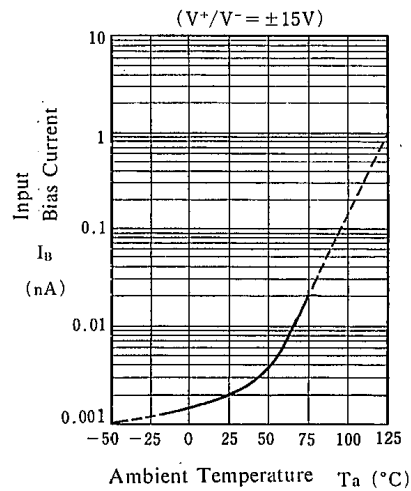

Maximum Output Voltage Swing vs. Operating Voltage

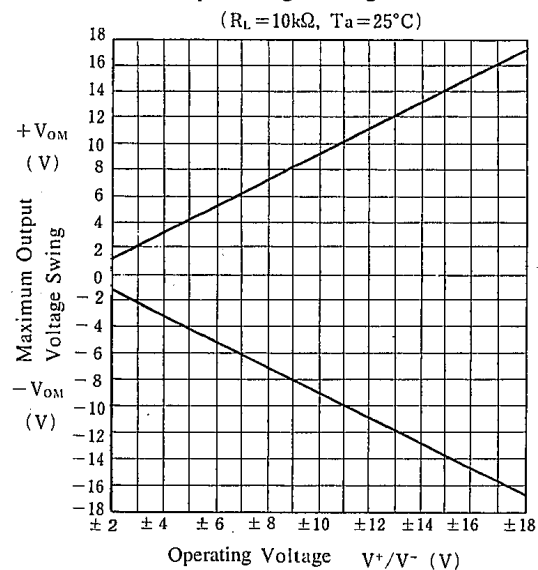

Operating Current vs. Operating Voltage

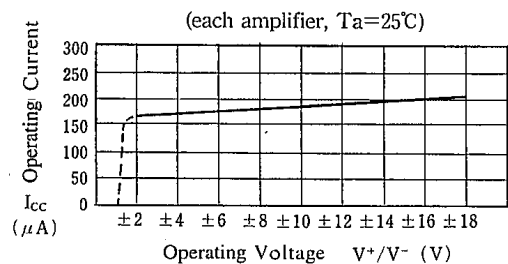

MEMO

[CAUTION]

The specifications on this databook are only given for information, without any guarantee as regards either mistakes or omissions. The application circuits in this databook are described only to show representative usages of the product and not intended for the guarantee or permission of any right including the industrial rights.