

Switching Regulator Controller

B3800

Step Up Low Voltage (BIPOLAR)

Description

The Bay Linear B3800 series is monolithic control circuit containing the primary functions required for DC-to-DC converters. This device is design for low voltage applications incorporating a soft start function and sort circuit detection function. The device has a low minimum operating voltage of 1.8V and is ideal for the power supply of battery-operated electronic equipments.

This series was specially designed to be incorporated in Step-Down and voltage-inverting applications with a minimum number of external components.

The B3800 is offer in 8-pin DIP or Surface mount package.

Features

- **Wide operation from..... 1.8 to 15V**
- **Low Standby Current..... 1 μ A**
- **Low Current Consumption..... 5.5mA**
- **high Speed Operation 1MHz**
- **Incorporates soft start circuit**
- **Incorporates a stand-by function**
- **Incorporate a times-latch short circuit detection circuit (SCP)**
- **Totem-pole type output with adjustable on/off current (for NPN transistor)**
- **The error amplifier gain is set inside the IC, so peripheral components are minimized.**
- **Direct Replacement for MB3800**

Applications

- **Digital Camera**
- **MP3**
- **Low Battery Operating Applications**

Pin Connection

Ordering Information



8-Pin Surface Mount

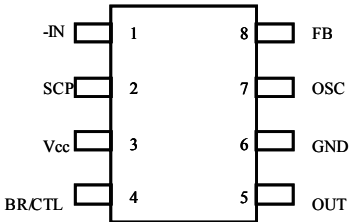

Top View

SO-8 8-pin	P-DIP 8-pin	Operating Temp. Range
B3800M	B3800P	-40°C to 85°C

Downloaded from Elcodis.com electronic components distributor

PIN Description

Pin No.	Symbol	I/O	Description
1	-IN	I	Error amplifier inverting
2	SCP	-	Soft start and SCP setting capacitor connection pin
3	V _{CC}	-	Power supply pin
4	BR/CTL	I	Output current setting and control pin
5	V _{OUT}	O	Totem-pole type output pin
6	GND	-	Ground pin
7	OSC	-	Capacitor and resistor connection pin setting the oscillation frequency
8	FB	O	Error amplifier output pin

Absolute Maximum Rating

Parameter	Symbol	Value	Unit
Supply Voltage	V _{CC}	16	V
Output source current	I _O ⁺	-50	mA
Output sink current	I _O ⁻	50	mA
Allowable dissipation	SOP-8, T _a ≤ +25°C	570	mW
	SOP-8, T _a ≤ +25°C	430	mW
	SSOP-8, T _a ≤ +25°C	580	mW
Operating temperature	T _{op}	-30 to +85	°C
Storage temperature	T _{stg}	-55 to +125	°C

WARNING: Semiconductor devices can be permanently damaged by application of stress (voltage, current, temperature, etc.) in excess of absolute maximum ratings. Do not exceed these ratings.

Recommended Operating Condition

Parameter	Symbol	Values			Unit
		Min	Typ.	Max.	
Power Supply Voltage	V _{CC}	1.8	-	15	V
Error amplifier input voltage	V _I	-0.2	-	1.0	V
BR/CTL pin input voltage	V _{BR}	-0.2	-	V _{CC}	V
Output source current	I _O ⁺	-40	-	-	mA
Output sink current	I _O ⁻	-	-	40	mA
SCP pin capacitance	C _{PE}	-	0.1	-	μF
Phase compensation capacitance	C _P	-	0.1	-	μF
Output current setting resistance	R _B	150	390	5000	Ω
Timing resistance	R _T	1.0	3.0	10.0	kΩ
Timing Capacitance	C _T	100	270	10000	pF
Oscillation frequency	f _{OSC}	10	500	1000	kHz
Operation temperature	T _{OP}	-30	+30	+85	°C

WARNING: Recommended operating conditions are normal operating ranges for the semiconductor device. All the device's electrical characteristics are warranted when operated within these ranges. Always use semiconductor devices within the recommended operating conditions. Operation outside these ranges may adversely affect reliability and could result in device failure.

No warranty is made with respect to uses, operating conditions, or combinations not represented on the data sheet. Users considering application outside the listed conditions are advised to contact Bay Linear.

Electrical Characteristics

Parameter		Symbol	Conditions	Value			Unit
				Min.	Typ.	Max.	
Circuit to Prevent Malfunction at low input voltage (U.V.L.O.)	Reset Voltage	V_R	-	-	-	0.9	V
	Threshold voltage	V_{TH}		1.1	1.3	1.5	V
Soft Start	Changing current	I_{CS}		-1.5	-1.0	-0.7	μA
	Voltage at soft start completion	V_{TS}	$V_{SCP}=0V$	0.7	0.8	0.9	V
Short Circuit detection (OSC)	Charging current	I_{cpc}	$V_{SCP}=0V$	-1.5	-1.0	-0.7	μA
	Threshold voltage	V_{PC}	-	0.7	0.8	0.9	V
Sawtooth wave oscillator (OSC)	Oscillation freq.	f_{ocs}	$R_T=3.0k\Omega, C_T=270pF$	400	500	600	kH z
	Frequency input stability	f_{dv}	$V_{CC}=2V$ to 15V	-	2	10	%
	Frequency variation with temperature	f_{dt}	$T_a=-30^\circ C$ to $+85^\circ C$	-	5	-	%
Error amplifier	Input threshold voltage	V_T	$V_{FB}=450mV$	480	500	520	mV
	V_T input stability	V_{Tdv}	$V_{CC}= 2V$ to 15V	-	5	20	mV
	V_T variation with temperature	V_{TDT}	$T_a= -30^\circ C$ to $+85^\circ C$	-	1	-	%
	Input bias current	I_B	$V_{IN}=0V$	-1.0	-0.2	1.0	μA
	Voltage gain	A_V	-	70	100	145	V/ V
	Frequency bandwidth	BW	$A_V=0dB$	-	6	-	M Hz
	Maximum output voltage range	V_{OM}^+ V_{OM}^-	-	0.78 -	0.87 0.05	- 0.2	V
	Output source current	I_{OM}^+	$V_{FB}=0.45V$	-	-40	-24	μA
Output sink current	I_{OM}^-	24		40	-	μA	
Idle period adjustable section	Maximum duty cycle	t_{DUTY}	$R_T=3.0k\Omega, C_T=270pF$ $V_{FB}=0.8V$	65	75	85	%
Output section	Output voltage	V_{OH1}	$R_B=390\Omega, I_O= -15mA$	1.0	1.2	-	V
		V_{OH2}	$R_B=750\Omega, I_O= -10mA,$ $V_{CC}=1.8V$	0.8	1.0	-	V
		V_{OL1}	$R_B=390\Omega, I_O=15mA$	-	0.1	0.2	V
		V_{OL2}	$R_B=750\Omega, I_O=10mA,$ $V_{CC}=1.8V$	-	0.1	0.2	V
	Output source current	I_O^+	$R_B=390\Omega, V_{CC}=0.9V$	-	-30	-20	mA
	Output sink current	I_O^-	$R_B=390\Omega, V_{CC}=0.3V$	30	60	-	mA
Output current setting section/ Control section	Pull down resistance	R_O	-	20	30	40	k Ω
	Pin Voltage	V_{BR}	$R_B=390\Omega,$	0.2	0.3	0.4	V
	Input off condition	I_{OFF}	-	-20	-	0	μA
	Input on condition	I_{ON}		-	-	-45	μA
Pin current range	I_{BR}	-1.8		-	-0.1	mA	
Entire device	Stand-by current	I_{CCB}	BR/CTL pin open or V_{cc}	-	-	1	mA
	Average supply current	I_{CC}	$R_B=390\Omega,$	-	5.5	9.3	mA

TIMMING DIAGRAM

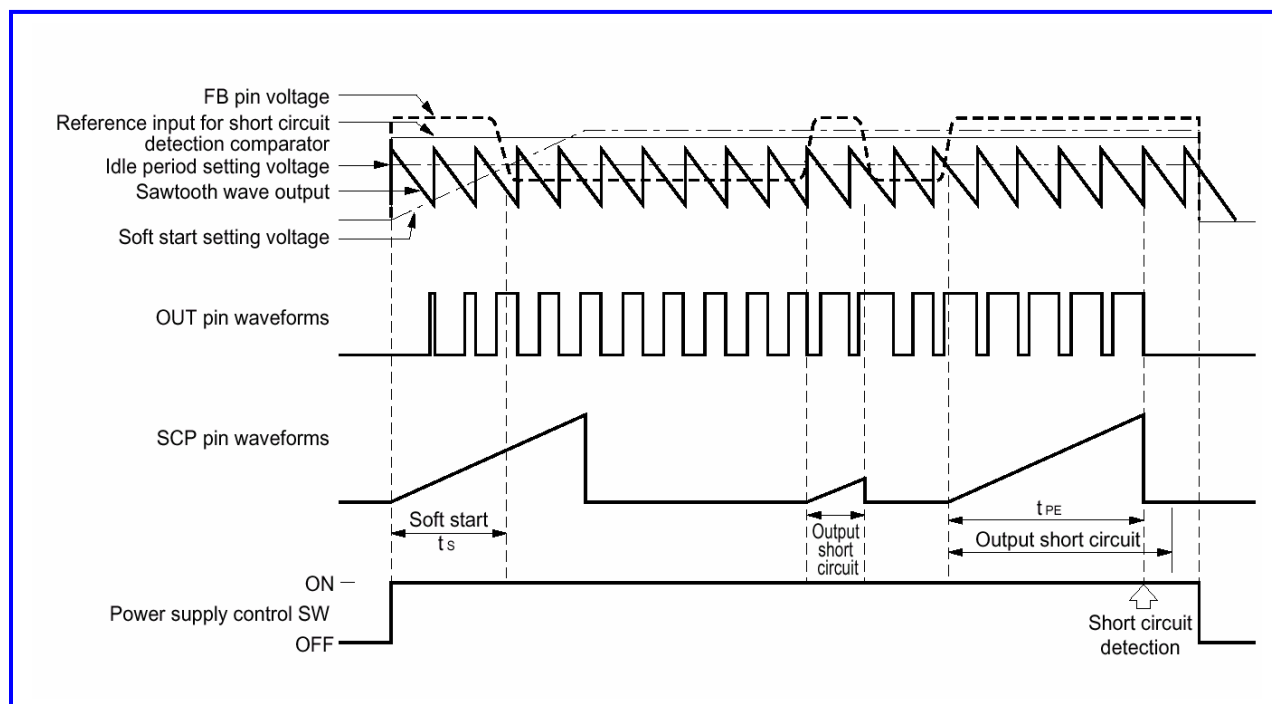

BLOCK DIAGRAM

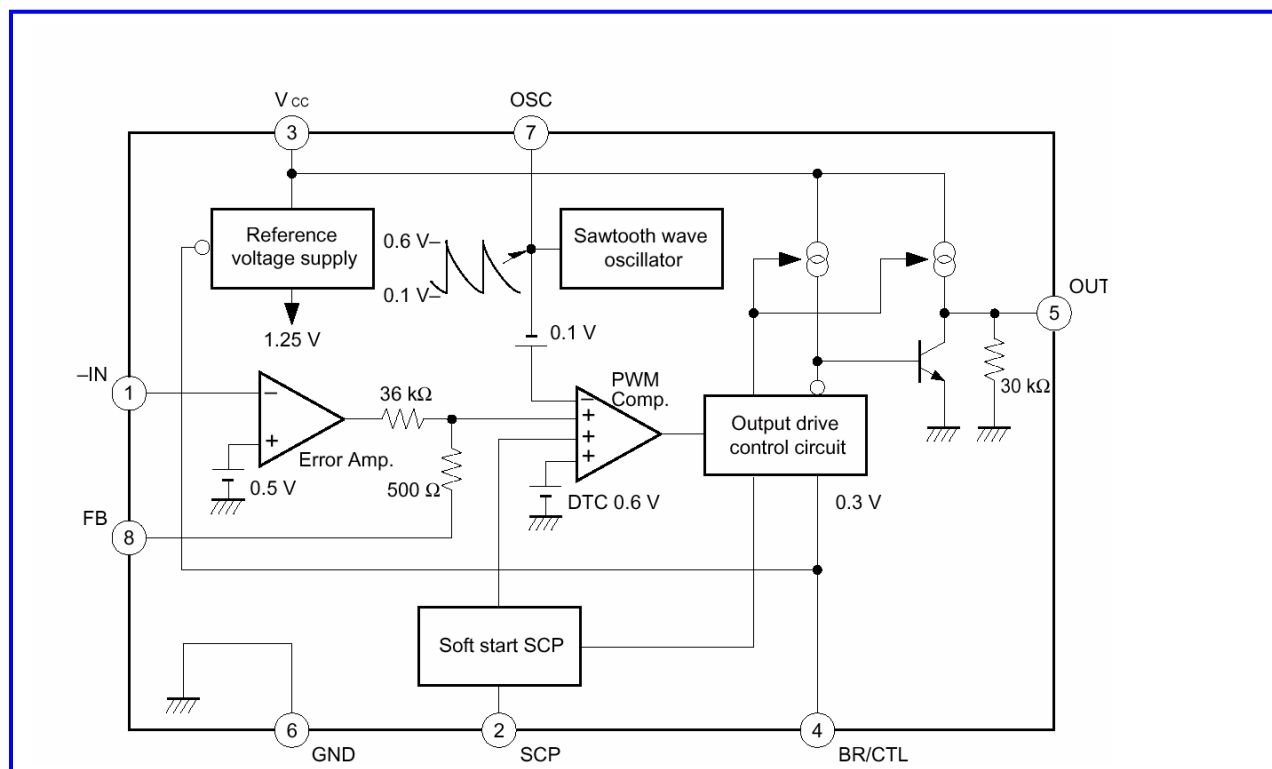

Typical Characteristics

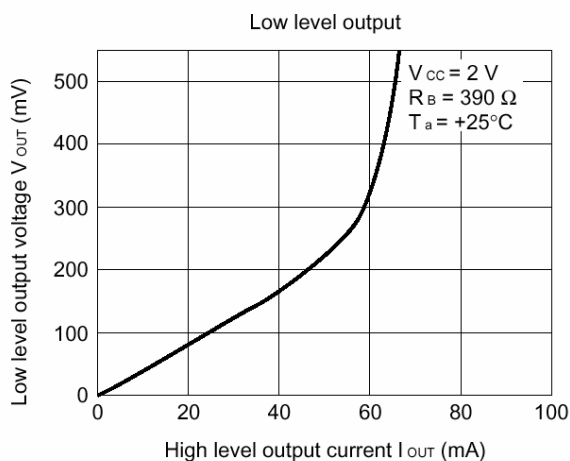
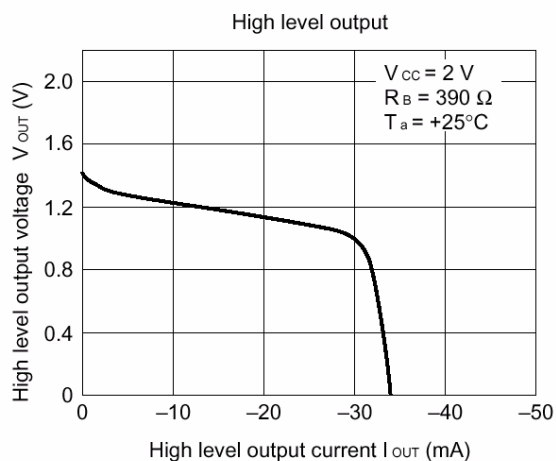
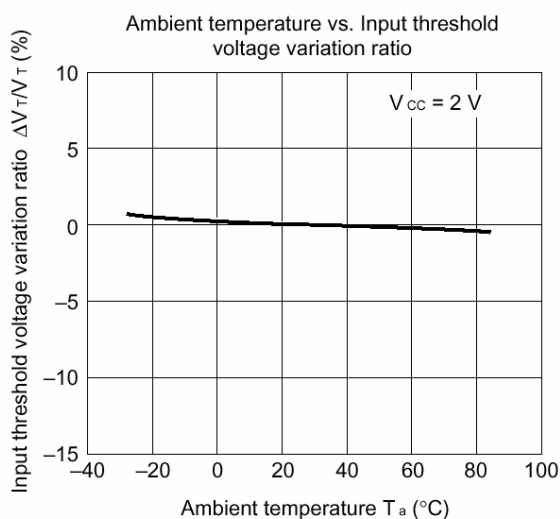
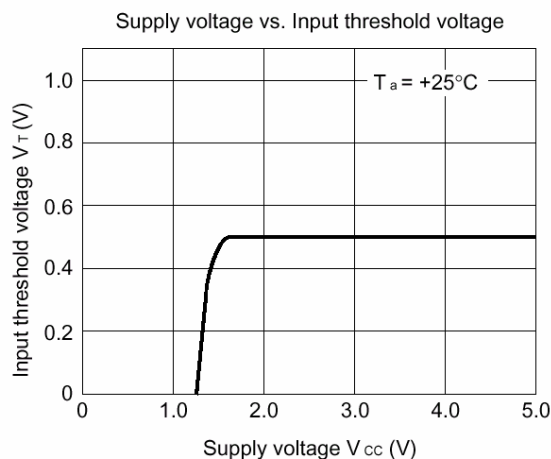
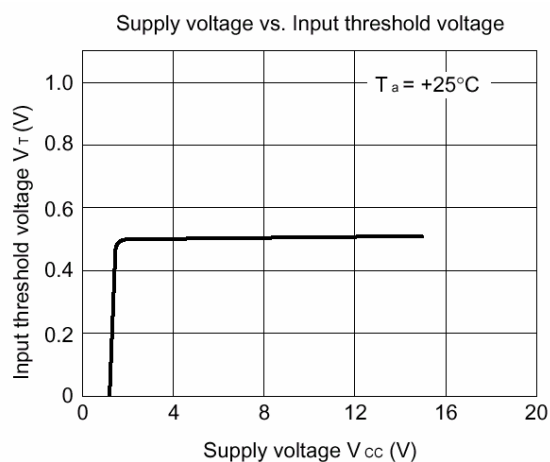
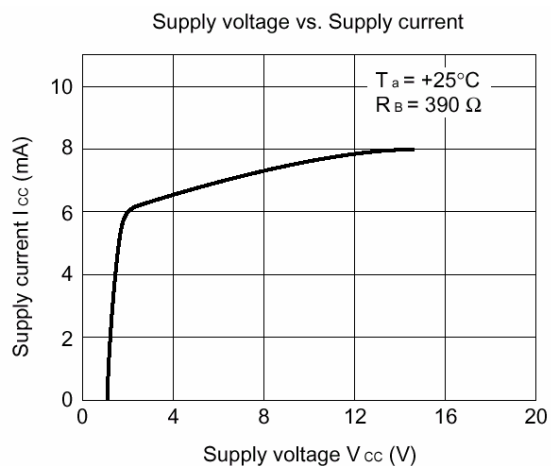

Typical Characteristics (continued)

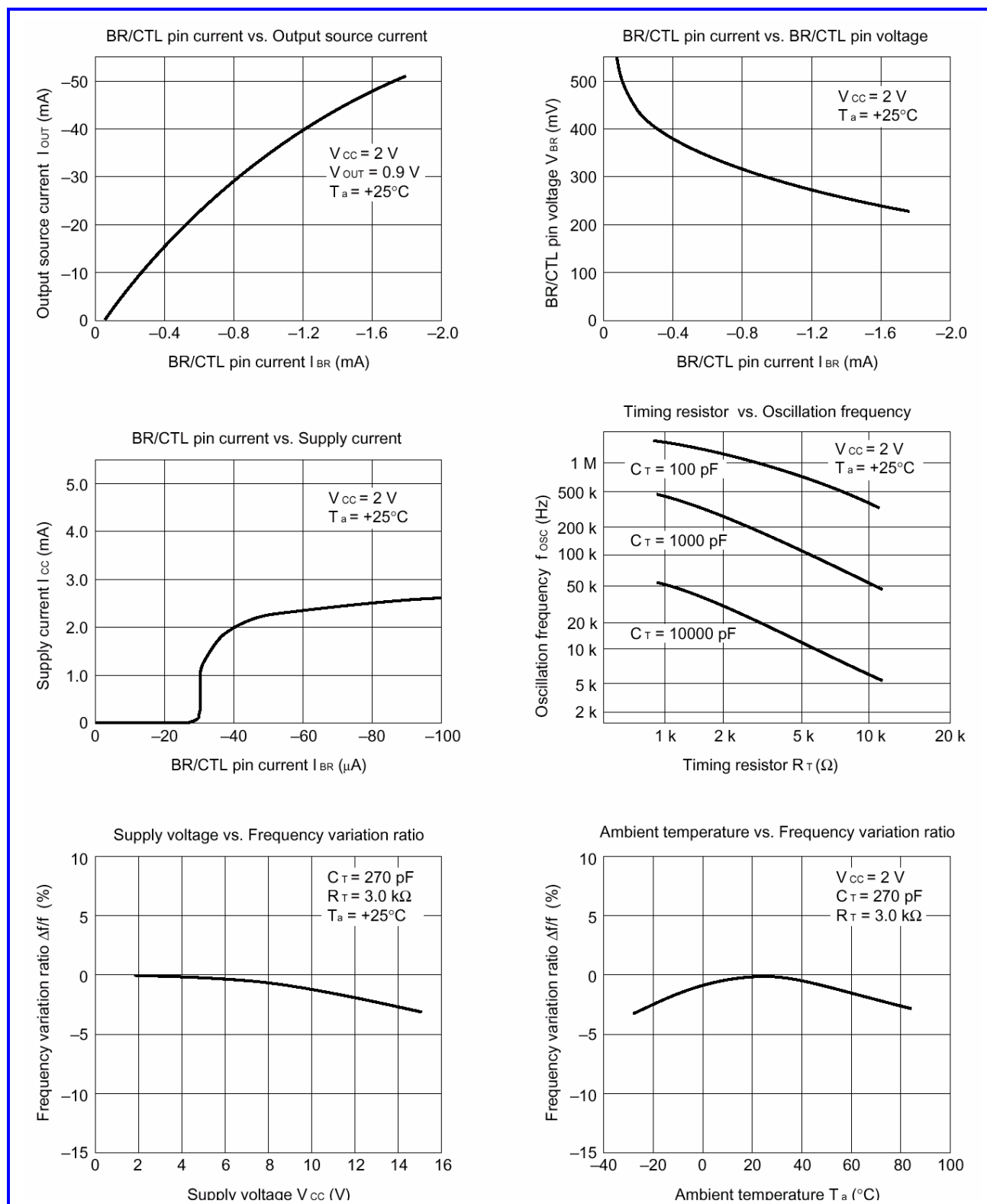

Typical Characteristics (continued)

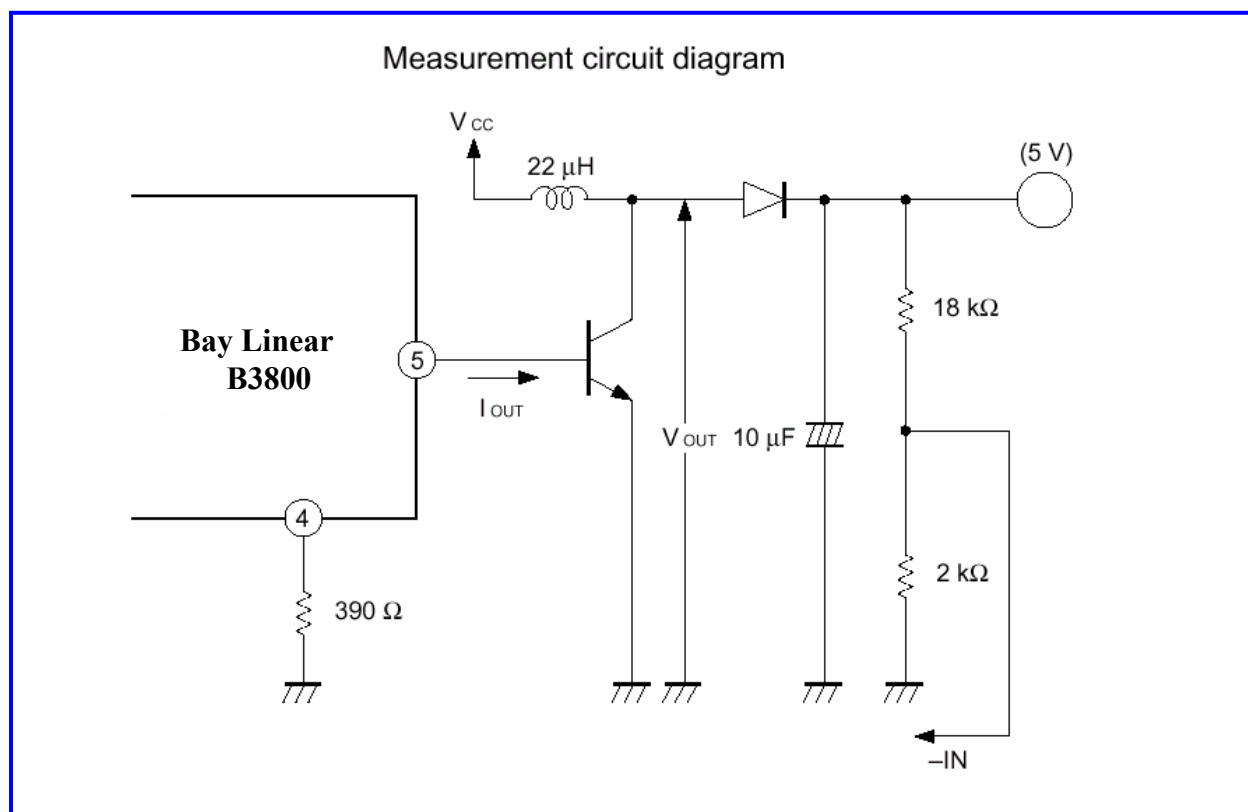
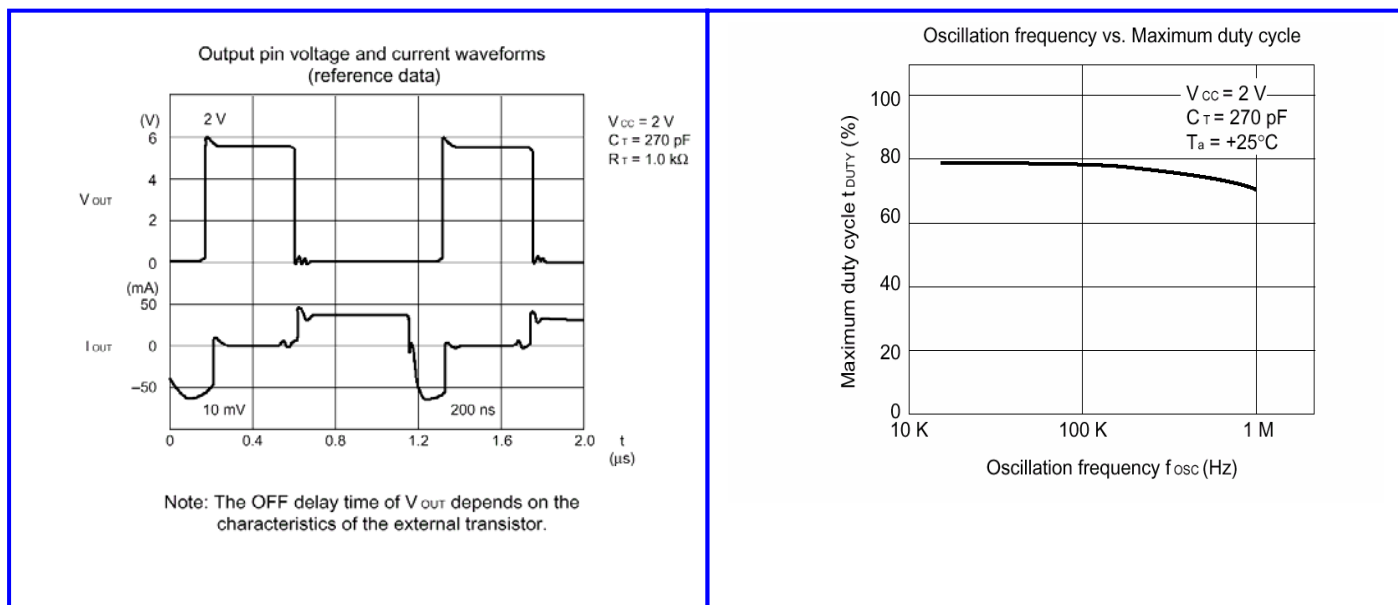

Application Descriptions

Power Supply Control Function

Stand-by mode (supply current 1 mA or less) can be set by connecting the BR/ CTL pin (pin 4) to VCC or by making the pin open circuit.

SW	Mode
OFF	Stand-by mode
ON	Operating mode

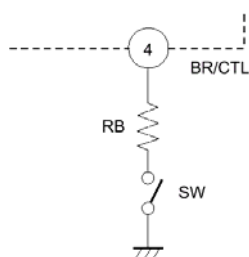

Switching Regulator Function

Reference voltage circuit

The reference voltage circuit generates a temperature-compensated reference voltage (@1.25V) from voltage supplied from the power supply pin (pin 3). In addition to providing the reference voltage for the switching regulator, the circuit also sets the idle period.

Sawtooth wave oscillator

The sawtooth oscillator generates a sawtooth wave (up to 1 MHz) that is stable with respect to the supply voltage and temperature. The capacitor and resistor that set the oscillation frequency are connected to the OSC pin (pin 7).

Error amplifier (Error Amp.)

The error amplifier detects the output voltage of the switching regulator and outputs the PWM control signal. The voltage gain is fixed, and connecting a phase compensation capacitor to the FB pin (pin 8) provides stable phase compensation for the system.

PWM comparator (PWM Comp.)

The voltage comparator has one inverting and three non-inverting inputs. The comparator is a voltage/ pulse width converter that controls the ON time of the output pulse depending on the input voltage. The output level is high (H) when the sawtooth wave is lower than the error amplifier output voltage, soft start setting voltage, and idle period setting voltage.

Output circuit

The output circuit has a totem pole type configuration and can drive an external NPN transistor directly. The value of the ON/ OFF current can be set by a resistor connected to the BR/ CTL pin (pin 4).

Other Functions

Soft start and short circuit detection

Soft start operation is set by connecting capacitor CPE to the SCP pin (pin 2). Soft start prevents a current spike on start-up.

On completion of soft start operation, the SCP pin (pin 2) stays low and enters the short circuit detection wait state. When an output short circuit occurs, the error amplifier output is fixed at VOM+ and capacitor CPE starts charging. After charging to approximately 0.8 V, the output pin (pin 5) is set low and the SCP pin (pin 2) stays low.

Once the protection circuit operates, the circuit can be restored by resetting the power supply. (See "n HOW TO SET THE TIME CONSTANT FOR SOFT START AND SHORT CIRCUIT DETECTION".)

Circuit to prevent malfunction at low input voltage

Transients when powering on or instantaneous glitches in the supply voltage can lead to malfunction of the control IC and cause system damage or failure. The circuit to prevent malfunction at low input voltage detects a low input voltage by comparing the supply voltage to the internal reference voltage. On detection, the circuit fixes the output pin to low.

The system recovers when the supply voltage rises back above the threshold voltage of the malfunction prevention circuit.

HOW TO SET THE TIME CONSTANT FOR SOFT START AND SHORT CIRCUIT DETECTION

Soft Start

At power on, the capacitor CPE connected to the SCP pin starts charging. The PWM comparator compares the soft start setting voltage as a proportion of the voltage at the SCP pin with the sawtooth waveform. The comparison controls the ON duty of the OUT pin, causing the soft start operation. On completion of soft start operation, the voltage at the SCP pin stays low, the soft start setting voltage stays high, and the circuit enters the output short circuit detection wait state. Soft start time (The time until the output ON duty reaches approximately 50%) t_s [s] @ 0.35 · CPE [mF]

Short Circuit Protection

If the switching regulator output suddenly drops due to load effect, the error amplifier output (FB pin) is fixed at VOM + and capacitor CPE starts charging. When the voltage at the SCP pin reaches approximately 0.8V, the output pin is set low and the SCP pin stays low. Once the protection circuit operates, the circuit can be restored by resetting the power supply. • Short circuit detection time

$$T_{PE} [s] @ 0.8 \cdot CPE [mF]$$

APPLICATION DIAGRAM

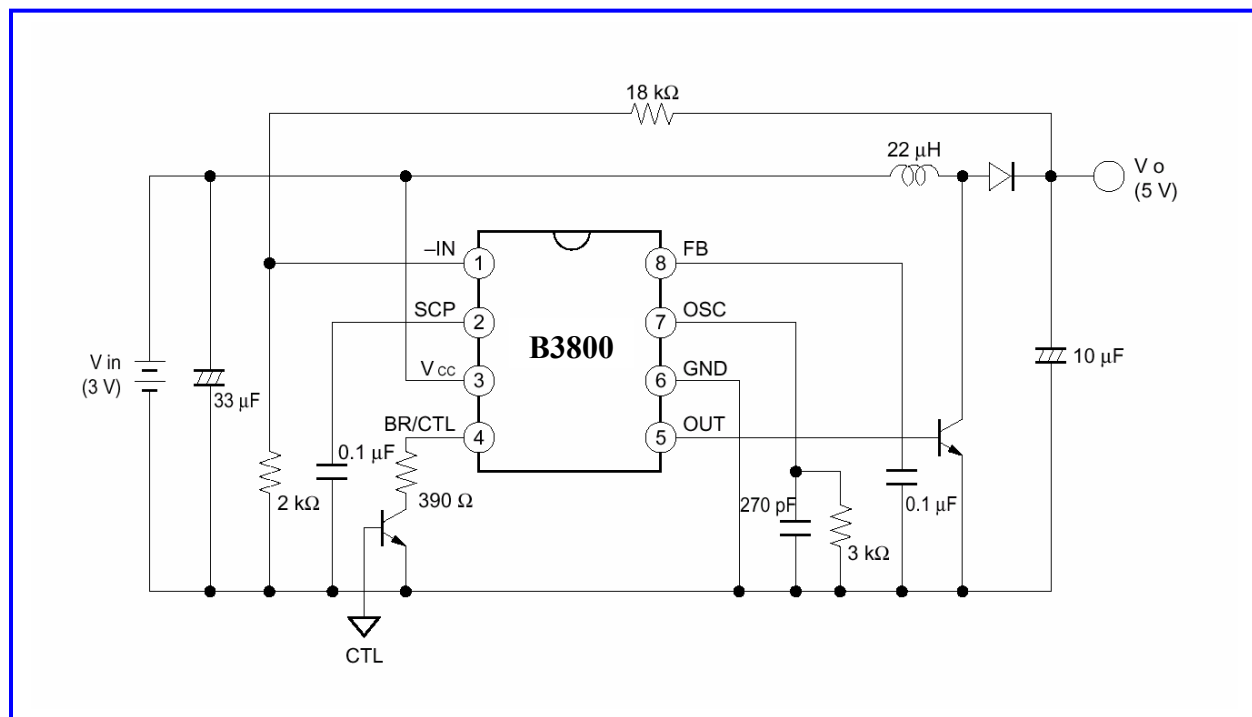

8 pin SOIC

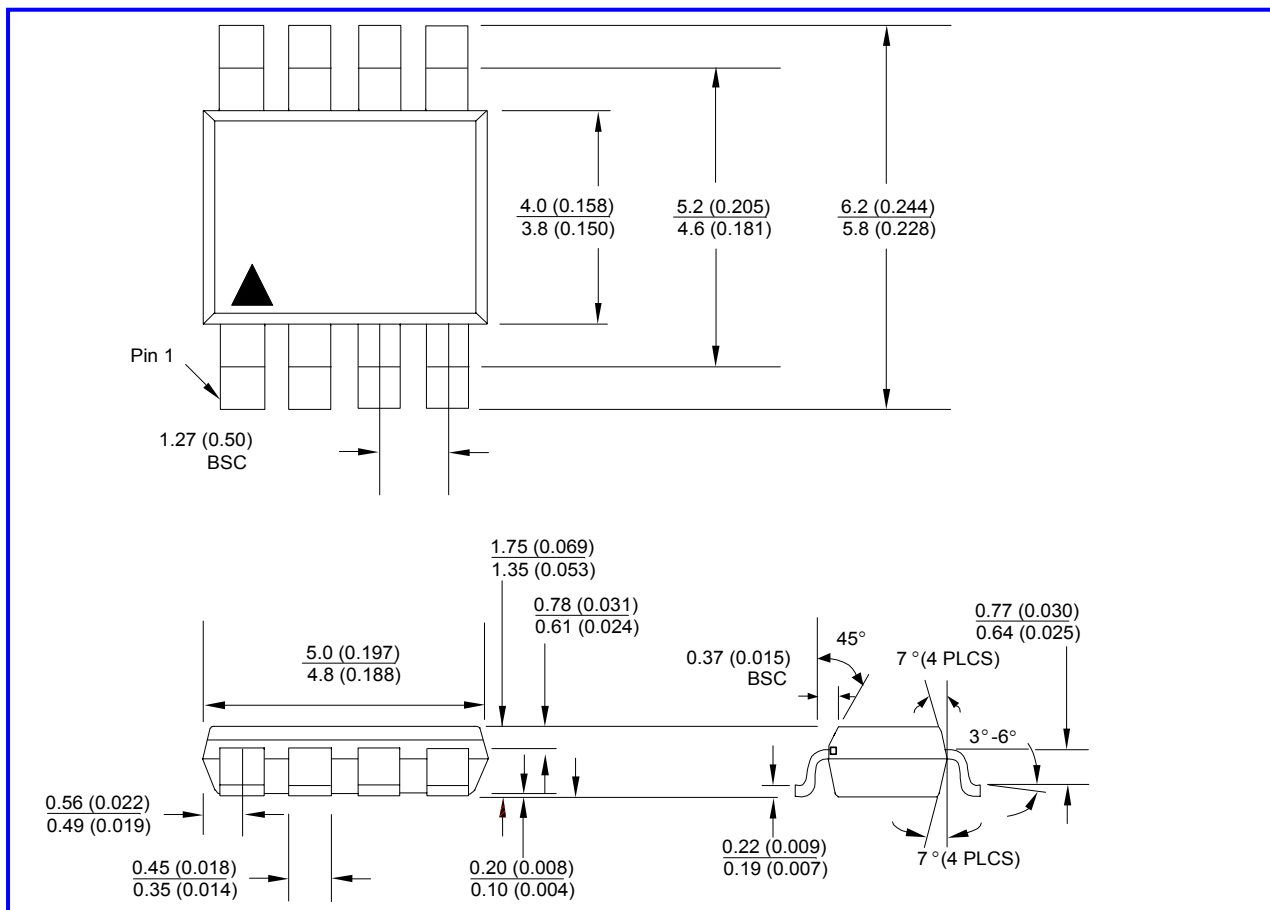

Advance Information- These data sheets contain descriptions of products that are in development. The specifications are based on the engineering calculations, computer simulations and/or initial prototype evaluation.

Preliminary Information- These data sheets contain minimum and maximum specifications that are based on the initial device characterizations. These limits are subject to change upon the completion of the full characterization over the specified temperature and supply voltage ranges.

The application circuit examples are only to explain the representative applications of the devices and are not intended to guarantee any circuit design or permit any industrial property right to other rights to execute. Bay Linear takes no responsibility for any problems related to any industrial property right resulting from the use of the contents shown in the data book. Typical parameters can and do vary in different applications. Customer's technical experts must validate all operating parameters including "Typical" for each customer application.

LIFE SUPPORT AND NUCLEAR POLICY

Bay Linear products are not authorized for and should not be used within life support systems which are intended for surgical implants into the body to support or sustain life, in aircraft, space equipment, submarine, or nuclear facility applications without the specific written consent of Bay Linear President.