

## Features

- Internal control latches and address decoder
- Short set-up and hold times
- Wide operating voltage: 4.5V to 13.2V
- 12Vpp analog signal capability
- $R_{ON}$  65 $\Omega$  max. @  $V_{DD}=12V$ , 25°C
- $\Delta R_{ON} \leq 10\Omega$  @  $V_{DD}=12V$ , 25°C
- Full CMOS switch for low distortion
- Minimum feedthrough and crosstalk
- Separate analog and digital reference supplies
- Low power consumption ISO-CMOS technology

## Applications

- Key systems
- PBX systems
- Mobile radio
- Test equipment /instrumentation
- Analog/digital multiplexers
- Audio/Video switching

### Ordering Information

|          |                    |
|----------|--------------------|
| MT8815AE | 40 Pin Plastic DIP |
| MT8815AP | 44 Pin PLCC        |

**-40° to 85°C**

## Description

The Zarlink MT8815 is fabricated in Zarlink's ISO-CMOS technology providing low power dissipation and high reliability. The device contains a 8 x 12 array of crosspoint switches along with a 7 to 96 line decoder and latch circuits. Any one of the 96 switches can be addressed by selecting the appropriate seven address bits. The selected switch can be turned on or off by applying a logical one or zero to the DATA input.  $V_{SS}$  is the ground reference of the digital inputs. The range of the analog signal is from  $V_{DD}$  to  $V_{EE}$ .

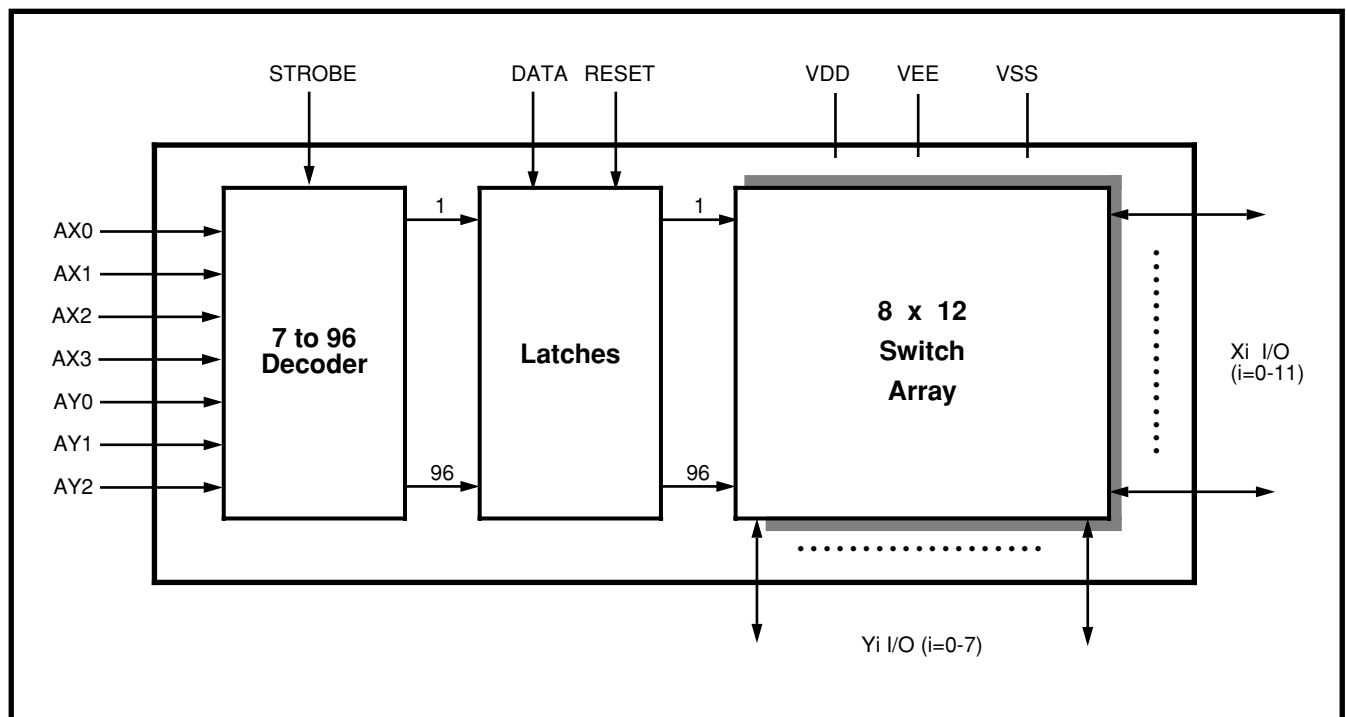

Figure 1 - Functional Block Diagram



## Pin Description

| Pin # |      | Name | Description  |
|-------|------|------|--|
| PDIP  | PLCC |      |  |
| 38    | 42   | DATA | <b>DATA (Input):</b> a logic high input will turn on the selected switch and a logic low will turn off the selected switch. Active High. |
| 39    | 43   | Y2   | <b>Y2 Analog (Input/Output):</b> this is connected to the Y2 column of the switch array.   |
| 40    | 44   | NC   | <b>No Connection.</b>  |

## Functional Description

The MT8815 is an analog switch matrix with an array size of 8×12. The switch array is arranged such that there are 8 columns by 12 rows. The columns are referred to as the Y inputs/outputs and the rows are the X inputs/outputs. The crosspoint analog switch array will interconnect any X I/O with any Y I/O when turned on and provide a high degree of isolation when turned off. The control memory consists of a 96 bit write only RAM in which the bits are selected by the address inputs (AY0-AY2, AX0-AX3). Data is presented to the memory on the DATA input. Data is asynchronously written into memory whenever the STROBE input is high and is latched on the falling edge of STROBE. A logical "1" written into a memory cell turns the corresponding crosspoint switch on and a logical "0" turns the crosspoint off. Only the crosspoint switches corresponding to the addressed memory location are altered when data is written into memory. The remaining switches retain their previous states. Any combination of X and Y inputs/outputs can be interconnected by establishing appropriate patterns in the control memory. A logical "1" on the RESET input will asynchronously return all memory locations to logical "0" turning off all crosspoint switches. Two voltage reference pins ( $V_{SS}$  and  $V_{EE}$ ) are provided for the MT8815 to enable switching of negative analog signals. The range for digital signals is from  $V_{DD}$  to  $V_{SS}$  while the range for analog signals is from  $V_{DD}$  to  $V_{EE}$ .  $V_{SS}$  and  $V_{EE}$  pins can be tied together if a single voltage reference is needed.

## Address Decode

The seven address inputs along with the STROBE are logically ANDed to form an enable signal for the resettable transparent latches. The DATA input is buffered and is used as the input to all latches. To write to a location, RESET must be low while the address and data are set up. Then the STROBE input is set high and then low causing the data to be latched. The data can be changed while STROBE is high, however, the corresponding switch will turn on and off in accordance with the DATA input. DATA must be stable on the falling edge of STROBE in order for correct data to be written to the latch.

**Absolute Maximum Ratings\*** - Voltages are with respect to  $V_{EE}$  unless otherwise stated.

|   | Parameter                 | Symbol               | Min          | Max          | Units |
|---|---------------------------|----------------------|--------------|--------------|-------|
| 1 | Supply Voltage            | $V_{DD}$             | -0.3         | 15.0         | V     |
|   |                           | $V_{SS}$             | -0.3         | $V_{DD}+0.3$ | V     |
| 2 | Analog Input Voltage      | $V_{INA}$            | -0.3         | $V_{DD}+0.3$ | V     |
| 3 | Digital Input Voltage     | $V_{IN}$             | $V_{SS}-0.3$ | $V_{DD}+0.3$ | V     |
| 4 | Current on any I/O Pin    | I                    |              | ±15          | mA    |
| 5 | Storage Temperature       | $T_S$                | -65          | +150         | °C    |
| 6 | Package Power Dissipation | PLASTIC DIP<br>$P_D$ |              | 0.6          | W     |

\* Exceeding these values may cause permanent damage. Functional operation under these conditions is not implied.

**Recommended Operating Conditions** - Voltages are with respect to  $V_{EE}$  unless otherwise stated.

|   | Characteristics       | Sym       | Min      | Typ | Max          | Units | Test Conditions |
|---|-----------------------|-----------|----------|-----|--------------|-------|-----------------|
| 1 | Operating Temperature | $T_O$     | -40      | 25  | 85           | °C    |                 |
| 2 | Supply Voltage        | $V_{DD}$  | 4.5      |     | 13.2         | V     |                 |
|   |                       | $V_{SS}$  | $V_{EE}$ |     | $V_{DD}-4.5$ | V     |                 |
| 3 | Analog Input Voltage  | $V_{INA}$ | $V_{EE}$ |     | $V_{DD}$     | V     |                 |
| 4 | Digital Input Voltage | $V_{IN}$  | $V_{SS}$ |     | $V_{DD}$     | V     |                 |

**DC Electrical Characteristics†** - Voltages are with respect to  $V_{EE}=V_{SS}=0V$ ,  $V_{DD}=12V$  unless otherwise stated.

|   | Characteristics                                 | Sym        | Min          | Typ‡ | Max           | Units | Test Conditions  |
|---|---|------------|--------------|------|---------------|-------|--|
| 1 | Quiescent Supply Current                        | $I_{DD}$   |              | 1    | 100           | µA    | All digital inputs at $V_{IN}=V_{SS}$ or $V_{DD}$              |
|   |   |            |              | 0.4  | 1.5           | mA    | All digital inputs at $V_{IN}=2.4V + V_{SS}$ ; $V_{SS}=7.0V$   |
|   |   |            |              | 5    | 15            | mA    | All digital inputs at $V_{IN}=3.4V$                            |
| 2 | Off-state Leakage Current (See G.9 in Appendix) | $I_{OFF}$  |              | ±1   | ±500          | nA    | $ V_{Xi} - V_{Yj}  = V_{DD} - V_{EE}$ . See Appendix, Fig. A.1 |
| 3 | Input Logic "0" level                           | $V_{IL}$   |              |      | $0.8+V_{S_s}$ | V     | $V_{SS}=7.5V$ ; $V_{EE}=0V$                                    |
| 4 | Input Logic "1" level                           | $V_{IH}$   | $2.0+V_{SS}$ |      |               | V     | $V_{SS}=6.5V$ ; $V_{EE}=0V$                                    |
| 5 | Input Logic "1" level                           | $V_{IH}$   | 3.3          |      |               | V     |  |
| 6 | Input Leakage (digital pins)                    | $I_{LEAK}$ |              | 0.1  | 10            | µA    | All digital inputs at $V_{IN} = V_{SS}$ or $V_{DD}$            |

† DC Electrical Characteristics are over recommended temperature range.

‡ Typical figures are at 25°C and are for design aid only; not guaranteed and not subject to production testing.

**DC Electrical Characteristics- Switch Resistance** -  $V_{DC}$  is the external DC offset applied at the analog I/O pins.

|   | Characteristics   | Sym             | 25°C |     | 70°C |     | 85°C |     | Units | Test Conditions  |
|---|---|-----------------|------|-----|------|-----|------|-----|-------|--|
|   |   |                 | Typ  | Max | Typ  | Max | Typ  | Max |       |  |
| 1 | On-state Resistance<br>$V_{DD}=12V$<br>$V_{DD}=10V$<br>$V_{DD}=5V$<br>(See G.1, G.2, G.3 in Appendix) | $R_{ON}$        | 45   | 65  |      | 75  |      | 80  | Ω     | $V_{SS}=V_{EE}=0V, V_{DC}=V_{DD}/2$ ,<br>$ V_{Xi}-V_{Yj}  = 0.4V$<br>See Appendix, Fig. A.2                  |
|   |   |                 | 55   | 75  |      | 85  |      | 90  | Ω     |  |
|   |   |                 | 120  | 185 |      | 215 |      | 225 | Ω     |  |
| 2 | Difference in on-state resistance between two switches<br>(See G.4 in Appendix)                       | $\Delta R_{ON}$ | 5    | 10  |      | 10  |      | 10  | Ω     | $V_{DD}=12V, V_{SS}=V_{EE}=0$ ,<br>$V_{DC}=V_{DD}/2$ ,<br>$ V_{Xi}-V_{Yj}  = 0.4V$<br>See Appendix, Fig. A.2 |

**AC Electrical Characteristics† - Crosspoint Performance** - Voltages are with respect to  $V_{DD}=5V$ ,  $V_{SS}=0V$ ,  $V_{EE}=-7V$ , unless otherwise stated.

|   | Characteristics  | Sym               | Min | Typ <sup>‡</sup> | Max | Units | Test Conditions   |
|---|--|-------------------|-----|------------------|-----|-------|---|
| 1 | Switch I/O Capacitance   | $C_S$             |     | 20               |     | pF    | $f=1$ MHz   |
| 2 | Feedthrough Capacitance  | $C_F$             |     | 0.2              |     | pF    | $f=1$ MHz   |
| 3 | Frequency Response<br>Channel "ON"<br>$20\text{LOG}(V_{OUT}/V_{Xi})=-3\text{dB}$   | $F_{3\text{dB}}$  |     | 45               |     | MHz   | Switch is "ON"; $V_{INA} = 2V_{pp}$ sine wave; $R_L = 1k\Omega$<br>See Appendix, Fig. A.3                           |
| 4 | Total Harmonic Distortion<br>(See G.5, G.6 in Appendix)  | THD               |     | 0.01             |     | %     | Switch is "ON"; $V_{INA} = 2V_{pp}$ sine wave $f= 1\text{kHz}$ ; $R_L=1k\Omega$                                     |
| 5 | Feedthrough<br>Channel "OFF"<br>Feed.= $20\text{LOG}(V_{OUT}/V_{Xi})$<br>(See G.8 in Appendix)   | FDT               |     | -95              |     | dB    | All Switches "OFF"; $V_{INA}= 2V_{pp}$ sine wave $f= 1\text{kHz}$ ; $R_L = 1k\Omega$ .<br>See Appendix, Fig. A.4    |
| 6 | Crosstalk between any two channels for switches $X_i$ - $Y_i$ and $X_j$ - $Y_j$ .<br><br>$X_{\text{talk}}=20\text{LOG}(V_{Yj}/V_{Xi})$ .<br><br>(See G.7 in Appendix). | $X_{\text{talk}}$ |     | -45              |     | dB    | $V_{INA}=2V_{pp}$ sine wave $f= 10\text{MHz}$ ; $R_L = 75\Omega$ .  |
|   |  |                   |     | -90              |     | dB    | $V_{INA}=2V_{pp}$ sine wave $f= 10\text{kHz}$ ; $R_L = 600\Omega$ .   |
|   |  |                   |     | -85              |     | dB    | $V_{INA}=2V_{pp}$ sine wave $f= 10\text{kHz}$ ; $R_L = 1k\Omega$ .  |
|   |  |                   |     | -80              |     | dB    | $V_{INA}=2V_{pp}$ sine wave $f= 1\text{kHz}$ ; $R_L = 10k\Omega$ .<br>Refer to Appendix, Fig. A.5 for test circuit. |
| 7 | Propagation delay through switch   | $t_{PS}$          |     |                  | 30  | ns    | $R_L=1k\Omega$ ; $C_L=50\text{pF}$  |

† Timing is over recommended temperature range. See Fig. 3 for control and I/O timing details.

‡ Typical figures are at 25°C and are for design aid only; not guaranteed and not subject to production testing.

Crosstalk measurements are for Plastic DIPs only, crosstalk values for PLCC packages are approximately 5dB better.

**AC Electrical Characteristics† - Control and I/O Timings** - Voltages are with respect to  $V_{DD}=5V$ ,  $V_{SS}=0V$ ,  $V_{EE}=-7V$ , unless otherwise stated.

|    | Characteristics  | Sym                | Min | Typ <sup>‡</sup> | Max | Units | Test Conditions   |
|----|--|--------------------|-----|------------------|-----|-------|---|
| 1  | Control Input crosstalk to switch<br>(for DATA, STROBE, Address) | $CX_{\text{talk}}$ |     | 30               |     | mVpp  | $V_{IN}=3V$ square wave;<br>$R_{IN}=1k\Omega$ , $R_L=10k\Omega$ .<br>See Appendix, Fig. A.6 |
| 2  | Digital Input Capacitance  | $C_{DI}$           |     | 10               |     | pF    | $f=1\text{MHz}$   |
| 3  | Switching Frequency  | $F_O$              |     |                  | 20  | MHz   |   |
| 4  | Setup Time DATA to STROBE  | $t_{DS}$           | 10  |                  |     | ns    | $R_L = 1k\Omega$ , $C_L=50\text{pF}$ ①  |
| 5  | Hold Time DATA to STROBE   | $t_{DH}$           | 10  |                  |     | ns    | $R_L = 1k\Omega$ , $C_L=50\text{pF}$ ①  |
| 6  | Setup Time Address to STROBE                                     | $t_{AS}$           | 10  |                  |     | ns    | $R_L = 1k\Omega$ , $C_L=50\text{pF}$ ①  |
| 7  | Hold Time Address to STROBE                                      | $t_{AH}$           | 10  |                  |     | ns    | $R_L = 1k\Omega$ , $C_L=50\text{pF}$ ①  |
| 8  | STROBE Pulse Width   | $t_{SPW}$          | 20  |                  |     | ns    | $R_L = 1k\Omega$ , $C_L=50\text{pF}$ ①  |
| 9  | RESET Pulse Width  | $t_{RPW}$          | 40  |                  |     | ns    | $R_L = 1k\Omega$ , $C_L=50\text{pF}$ ①  |
| 10 | STROBE to Switch Status Delay                                    | $t_S$              |     | 40               | 100 | ns    | $R_L = 1k\Omega$ , $C_L=50\text{pF}$ ①  |
| 11 | DATA to Switch Status Delay                                      | $t_D$              |     | 50               | 100 | ns    | $R_L = 1k\Omega$ , $C_L=50\text{pF}$ ①  |
| 12 | RESET to Switch Status Delay                                     | $t_R$              |     | 35               | 100 | ns    | $R_L = 1k\Omega$ , $C_L=50\text{pF}$ ①  |

† Timing is over recommended temperature range. See Fig. 3 for control and I/O timing details.

Digital Input rise time ( $t_r$ ) and fall time ( $t_f$ ) = 5ns.

‡ Typical figures are at 25°C and are for design aid only; not guaranteed and not subject to production testing.

① Refer to Appendix, Fig. A.7 for test circuit.

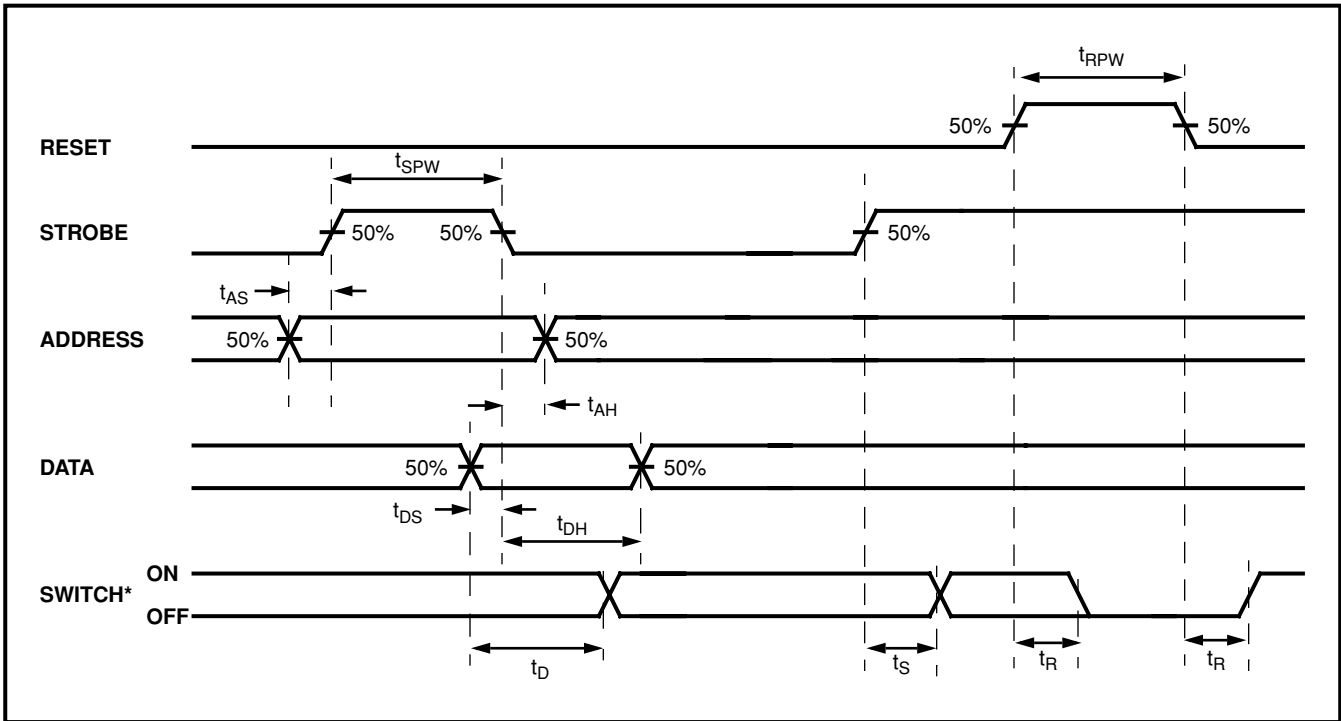

Figure 3 - Control Memory Timing Diagram

\* See Appendix, Fig. A.7 for switching waveform

| AX0 | AX1 | AX2 | AX3 | AY0 | AY1 | AY2 | Connection      |
|-----|-----|-----|-----|-----|-----|-----|-----------------|
| 0   | 0   | 0   | 0   | 0   | 0   | 0   | X0-Y0           |
| 1   | 0   | 0   | 0   | 0   | 0   | 0   | X1-Y0           |
| 0   | 1   | 0   | 0   | 0   | 0   | 0   | X2-Y0           |
| 1   | 1   | 0   | 0   | 0   | 0   | 0   | X3-Y0           |
| 0   | 0   | 1   | 0   | 0   | 0   | 0   | X4-Y0           |
| 1   | 0   | 1   | 0   | 0   | 0   | 0   | X5-Y0           |
| 0   | 1   | 1   | 0   | 0   | 0   | 0   | No Connection ① |
| 1   | 1   | 1   | 0   | 0   | 0   | 0   | No Connection ① |
| 0   | 0   | 0   | 1   | 0   | 0   | 0   | X6-Y0           |
| 1   | 0   | 0   | 1   | 0   | 0   | 0   | X7-Y0           |
| 0   | 1   | 0   | 1   | 0   | 0   | 0   | X8-Y0           |
| 1   | 1   | 0   | 1   | 0   | 0   | 0   | X9-Y0           |
| 0   | 0   | 1   | 1   | 0   | 0   | 0   | X10-Y0          |
| 1   | 0   | 1   | 1   | 0   | 0   | 0   | X11-Y0          |
| 0   | 1   | 1   | 1   | 0   | 0   | 0   | No Connection ① |
| 1   | 1   | 1   | 1   | 0   | 0   | 0   | No Connection ① |
| 0   | 0   | 0   | 0   | 1   | 0   | 0   | X0-Y1           |
| 1   | 0   | 1   | 1   | 1   | 0   | 0   | X11-Y1          |
| 0   | 0   | 0   | 0   | 0   | 1   | 0   | X0-Y2           |
| 1   | 0   | 1   | 1   | 0   | 1   | 0   | X11-Y2          |
| 0   | 0   | 0   | 0   | 1   | 1   | 0   | X0-Y3           |
| 1   | 0   | 1   | 1   | 1   | 1   | 0   | X11-Y3          |
| 0   | 0   | 0   | 0   | 0   | 0   | 1   | X0-Y4           |
| 1   | 0   | 1   | 1   | 0   | 0   | 1   | X11-Y4          |
| 0   | 0   | 0   | 0   | 1   | 0   | 1   | X0-Y5           |
| 1   | 0   | 1   | 1   | 1   | 0   | 1   | X11-Y5          |
| 0   | 0   | 0   | 0   | 0   | 1   | 1   | X0-Y6           |
| 1   | 0   | 1   | 1   | 0   | 1   | 1   | X11-Y6          |
| 0   | 0   | 0   | 0   | 1   | 1   | 1   | X0-Y7           |
| 1   | 0   | 1   | 1   | 1   | 1   | 1   | X11-Y7          |

Table 1. Address Decode Truth Table

① This address has no effect on device status.

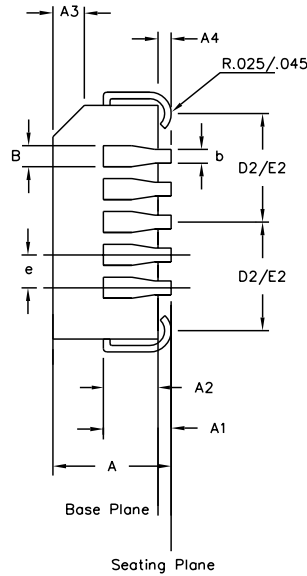
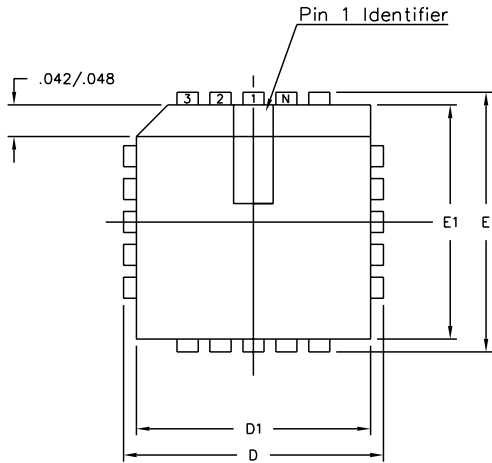

| Symbol                            | Control Dimensions<br>in inches |       | Altern. Dimensions<br>in millimetres |       |
|-----------------------------------|---------------------------------|-------|--------------------------------------|-------|
|                                   | MIN                             | MAX   | MIN                                  | MAX   |
| A                                 | 0.165                           | 0.180 | 4.19                                 | 4.57  |
| A1                                | 0.090                           | 0.120 | 2.29                                 | 3.05  |
| A2                                | 0.062                           | 0.083 | 1.57                                 | 2.11  |
| A3                                | 0.042                           | 0.056 | 1.07                                 | 1.42  |
| A4                                | 0.020                           | —     | 0.51                                 | —     |
| D                                 | 0.685                           | 0.695 | 17.40                                | 17.65 |
| D1                                | 0.650                           | 0.656 | 16.51                                | 16.66 |
| D2                                | 0.291                           | 0.319 | 7.39                                 | 8.10  |
| E                                 | 0.685                           | 0.695 | 17.40                                | 17.65 |
| E1                                | 0.650                           | 0.656 | 16.51                                | 16.66 |
| E2                                | 0.291                           | 0.319 | 7.39                                 | 8.10  |
| B                                 | 0.026                           | 0.032 | 0.66                                 | 0.81  |
| b                                 | 0.013                           | 0.021 | 0.33                                 | 0.53  |
| e                                 | 0.050                           | BSC   | 1.27                                 | BSC   |
| Pin features                      |                                 |       |                                      |       |
| ND                                | 11                              |       |                                      |       |
| NE                                | 11                              |       |                                      |       |
| N                                 | 44                              |       |                                      |       |
| Note                              | Square                          |       |                                      |       |
| Conforms to JEDEC MS-018AC Iss. A |                                 |       |                                      |       |

Notes:

1. All dimensions and tolerances conform to ANSI Y14.5M-1982
2. Dimensions D1 and E1 do not include mould protrusions. Allowable mould protrusion is 0.010" per side. Dimensions D1 and E1 include mould protrusion mismatch and are determined at the parting line, that is D1 and E1 are measured at the extreme material condition at the upper or lower parting line.
3. Controlling dimensions in Inches.
4. "N" is the number of terminals.
5. Not To Scale
6. Dimension R required for 120° minimum bend.

© Zarlink Semiconductor 2002 All rights reserved.

| ISSUE  | 1       | 2       | 3       |  |
|--------|---------|---------|---------|--|
| ACN    | 5958    | 207470  | 213094  |  |
| DATE   | 15Aug94 | 10Sep99 | 15Jul02 |  |
| APPRD. |         |         |         |  |



Previous package codes

HP / P

Package Code QA

Package Outline for  
44 lead PLCC

GPD00003

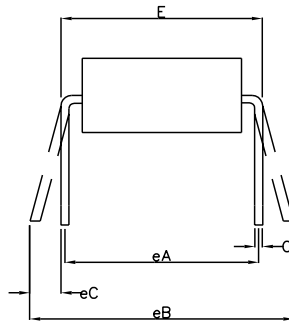
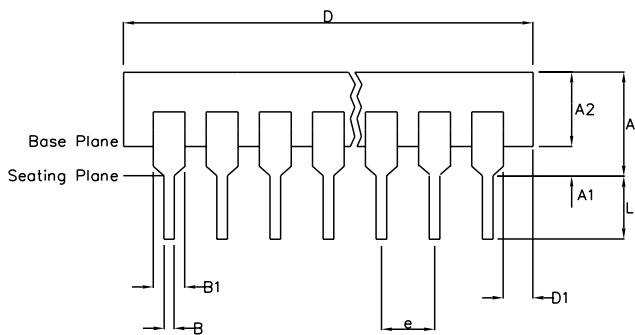
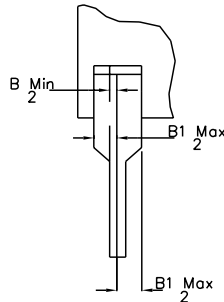
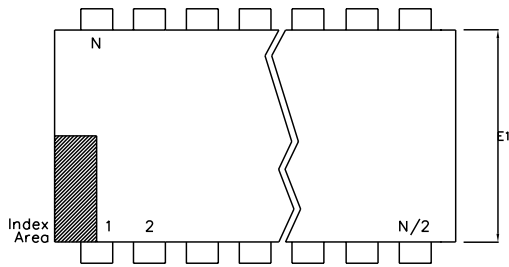

|                                  | Min mm    | Max mm | Min Inches | Max Inches |
|----------------------------------|-----------|--------|------------|------------|
| A                                |           | 6.35   |            | 0.250      |
| A1                               | 0.38      |        | 0.015      |            |
| A2                               | 3.18      | 4.95   | 0.125      | 0.195      |
| B                                | 0.36      | 0.56   | 0.014      | 0.022      |
| B1                               | 0.76      | 1.78   | 0.030      | 0.070      |
| C                                | 0.20      | 0.38   | 0.008      | 0.015      |
| D                                | 50.29     | 53.21  | 1.980      | 2.095      |
| D1                               | 0.13      |        | 0.005      |            |
| E                                | 15.24     | 15.88  | 0.600      | 0.625      |
| E1                               | 12.32     | 14.73  | 0.485      | 0.580      |
| e                                | 2.54 BSC  |        | 0.100 BSC  |            |
| eA                               | 15.24 BSC |        | 0.600 BSC  |            |
| eB                               |           | 17.78  |            | 0.700      |
| L                                | 2.92      | 5.08   | 0.115      | 0.200      |
| N                                | 40        |        | 40         |            |
| Conforms to Jeduc MS-011AC ISS.B |           |        |            |            |

- Notes:
1. Controlling Dimensions are in inches
  2. Dimension A, A1 and L are measured with the package seated in the Seating Plane
  3. Dimensions D & E1 do not include mould flash or protrusions. Mould flash or protrusion shall not exceed 0.010 inch.
  4. Dimensions E & eA are measured with leads constrained to be perpendicular to plane T.
  5. Dimensions eB & eC are measured at the lead tips with the leads unconstrained; eC must be zero or greater.

|   |         |         |         |  |                        |                                  |
|---|---------|---------|---------|--|------------------------|----------------------------------|
| © Zarlink Semiconductor 2002 All rights reserved. |         |         |         |  | Package Code           | DA                               |
| ISSUE   | 1       | 2       | 3       |  | Previous package codes | Package Outline for 40 lead PDIP |
| ACN   | 7010    | 203533  | 213103  |  | DP / E                 |                                  |
| DATE  | 20Apr95 | 25Nov97 | 15Jul02 |  |                        | GPD00073                         |
| APPRD.  |         |         |         |  |                        |                                  |





**For more information about all Zarlink products  
visit our Web Site at  
[www.zarlink.com](http://www.zarlink.com)**

Information relating to products and services furnished herein by Zarlink Semiconductor Inc. or its subsidiaries (collectively "Zarlink") is believed to be reliable. However, Zarlink assumes no liability for errors that may appear in this publication, or for liability otherwise arising from the application or use of any such information, product or service or for any infringement of patents or other intellectual property rights owned by third parties which may result from such application or use. Neither the supply of such information or purchase of product or service conveys any license, either express or implied, under patents or other intellectual property rights owned by Zarlink or licensed from third parties by Zarlink, whatsoever. Purchasers of products are also hereby notified that the use of product in certain ways or in combination with Zarlink, or non-Zarlink furnished goods or services may infringe patents or other intellectual property rights owned by Zarlink.

This publication is issued to provide information only and (unless agreed by Zarlink in writing) may not be used, applied or reproduced for any purpose nor form part of any order or contract nor to be regarded as a representation relating to the products or services concerned. The products, their specifications, services and other information appearing in this publication are subject to change by Zarlink without notice. No warranty or guarantee express or implied is made regarding the capability, performance or suitability of any product or service. Information concerning possible methods of use is provided as a guide only and does not constitute any guarantee that such methods of use will be satisfactory in a specific piece of equipment. It is the user's responsibility to fully determine the performance and suitability of any equipment using such information and to ensure that any publication or data used is up to date and has not been superseded. Manufacturing does not necessarily include testing of all functions or parameters. These products are not suitable for use in any medical products whose failure to perform may result in significant injury or death to the user. All products and materials are sold and services provided subject to Zarlink's conditions of sale which are available on request.

Purchase of Zarlink's I<sup>2</sup>C components conveys a licence under the Philips I<sup>2</sup>C Patent rights to use these components in and I<sup>2</sup>C System, provided that the system conforms to the I<sup>2</sup>C Standard Specification as defined by Philips.

Zarlink, ZL and the Zarlink Semiconductor logo are trademarks of Zarlink Semiconductor Inc.

Copyright Zarlink Semiconductor Inc. All Rights Reserved.

**TECHNICAL DOCUMENTATION - NOT FOR RESALE**