

MT5050W-UG

Features

High Output Power
High Reliability
Blue-Green Color

Applications

Color Sensor
Paper Sensor
Bar Code Reader
Fiber Optics

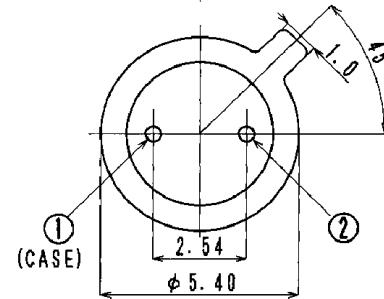
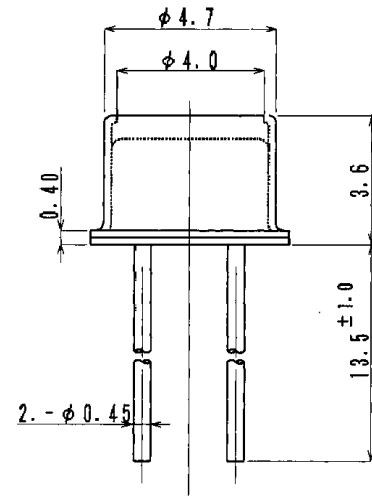

① Cathode ② Anode

Maximum Ratings (Ta=25°C)

Characteristic	Symbol	Max.	Test Condition	Unit
Forward Current	I _F	30	–	mA
Pulsed Forward Current	I _{FP}	.30	tw=10μ S, T=10mS	A
Reverse Voltage	V _R	5	–	V
Power Dissipation	P _d	120.00	–	mW
Operating Temperature	T _{opr}	-20~+85	–	°C
Storage Temperature	T _{stg}	-30 ~+100	–	°C
Junction Temperature	T _j	100	–	°C
Soldering Temperature	T _{sol}	260	for 5 sec. max	°C

Opto-Electrical Characteristics (Ta=25°C)

Characteristic	Symbol	Test Condition	Min	Typ	Max	Unit
Forward Voltage	V _F	I _F =20mA	–	3.40	4.00	V
Reverse Current	I _R	V _R =5V	–	–	100	μA
Power Output	PO	I _F =20mA	–	1.60	–	mW
Half Intensity Beam Angle	θ	–	–	± 28°	–	deg.
Peak Wavelength	λ _p	I _F =20mA	–	500	–	nm
Dominant Wavelength	λ _d	I _F =20mA	–	505	–	nm
Spectral Line Half Width	Δλ	I _F =20mA	–	35	–	nm

Company Headquarters

120 Broadway
Menands, New York 12204
Toll Free: 800.984.5337
Fax: 518.432.7454

West Coast Sales Office

100 Oceangate Blvd. #1200
Long Beach, CA 90802
Toll Free: 800.984.5337
Fax: 562.628.5572

MT5050W-UG Graphs

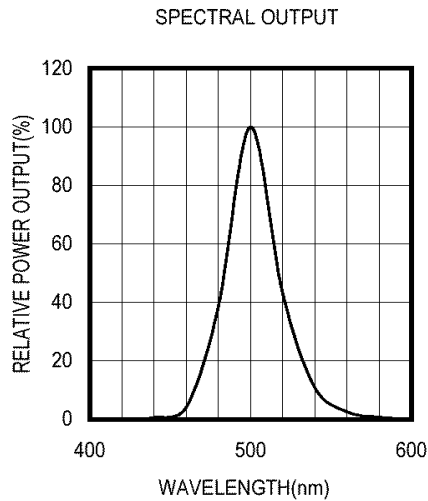
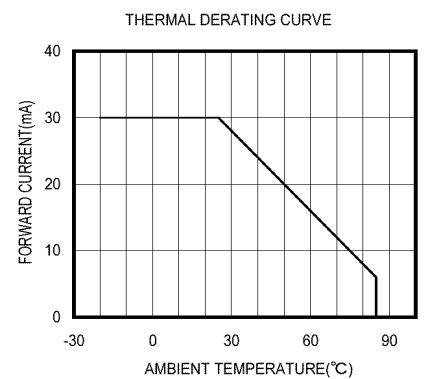
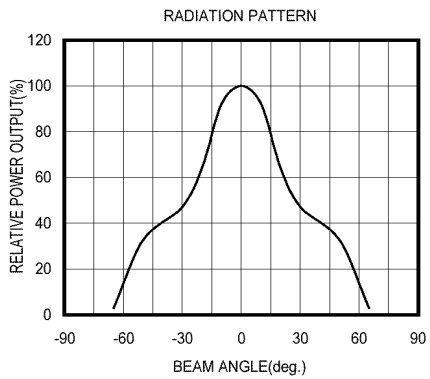
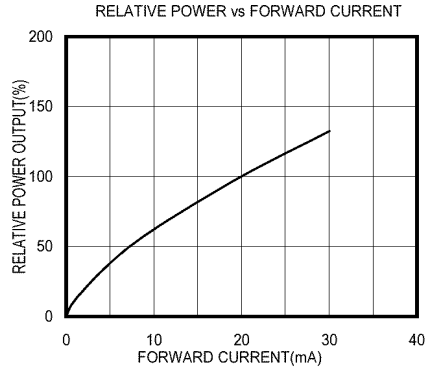
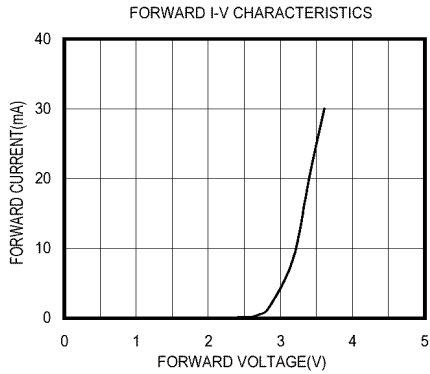

Company Headquarters
 120 Broadway
 Menands, New York 12204
 Toll Free: 800.984.5337
 Fax: 518.432.7454

West Coast Sales Office
 100 Oceangate Blvd. #1200
 Long Beach, CA 90802
 Toll Free: 800.984.5337
 Fax: 562.628.5572