

PHOTO IC COUPLER

MT26300, MT26310

T-41-89

APPLICATIONS

- DIGITAL LOGIC ISOLATION
- TELECOMMUNICATION
- ANALOG DATA EQUIPMENT CONTROL
- MICROPROCESSOR SYSTEM INTERFACE
- COMPUTER PERIPHERAL INTERFACE

The MARKTECH MT26300 and MT26310 dual photocouplers consist of a pair of GaAlAs light emitting diodes and integrated high gain, high speed photodetectors. Both units are 8 pin dip packages. The output of the detector circuit is an open collector Schottky clamped transistor. On the 26310 a Faraday shield is integrated on the photodetector chip reducing the effects of capacitance coupling between the input emitter and the high gain stages of the detector. This provides an effective common mode transient immunity of 1000V/μs.

FEATURES

- Input Current Threshold : $I_F=5\text{mA Max.}$
- LSTTL/TTL Compatible : 5V Supply
- Switching Speed : 10MBd (Typ.)
- Guaranteed Performance Over Temperature : 0 ~ 70°C
- Isolation Voltage : 2500 V_{rms} Min.
- Common Mode
- Transient Immunity : 1000V/μs Min. for MT26310

MT26300

PIN CONFIGURATION (TOP VIEW)

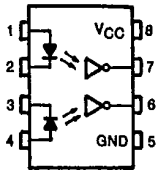

- 1: ANODE .1
- 2: CATHODE .1
- 3: CATHODE .2
- 4: ANODE .2
- 5: GND
- 6: V_{O2} (OUTPUT 2)
- 7: V_{O1} (OUTPUT 1)
- 8: V_{CC}

MT26310

PIN CONFIGURATION (TOP VIEW)

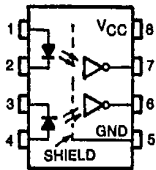

- 1: ANODE .1
- 2: CATHODE .1
- 3: CATHODE .2
- 4: ANODE .2
- 5: GND
- 6: V_{O2} (OUTPUT 2)
- 7: V_{O1} (OUTPUT 1)
- 8: V_{CC}

TRUTH TABLE
(Positive Logic)

Input	Output
H	L
L	H

A 0.01 to 0.1 μF bypass capacitor must connect between pins 8 and 5 (See Note 1).

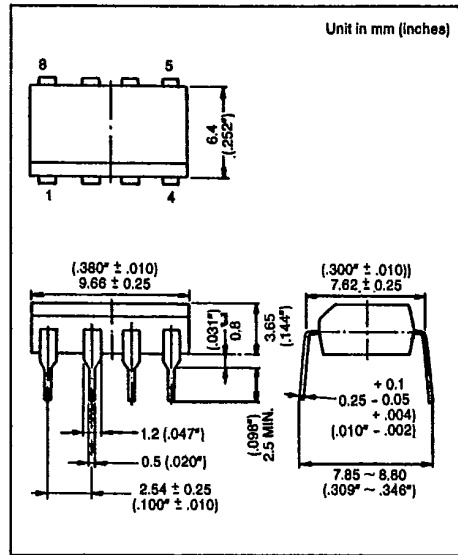

MT26300 SCHEMATIC

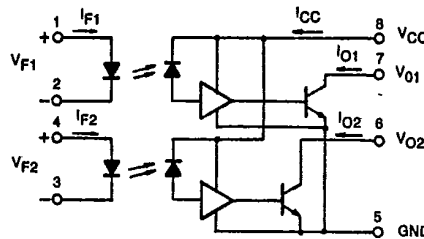

MT26310 SCHEMATIC

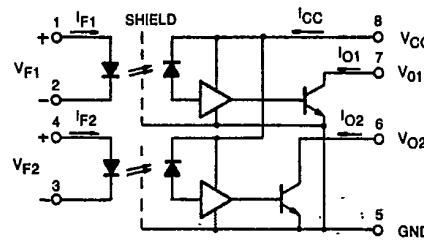

PHOTO IC COUPLER *T-41-89*

RECOMMENDED OPERATING CONDITIONS

CHARACTERISTIC	SYMBOL	MIN.	TYP.	MAX.	UNIT
Input Current, Low Level, Each channel	I _{FL}	0	—	250	μA
Input Current, High Level, Each channel	I _{FH}	6.3*	—	15	mA
Supply Voltage, Output	V _{CC}	4.5	5	5.5	V
Fan Out (TTL Load, Each channel)	N	—	—	8	—
Operating Temperature	T _{opr}	0	—	70	°C

* 6.3mA is a guard banded value which allows for at least 20% CTR degradation.
Initial input current threshold value is 5.0mA or less.

MAXIMUM RATINGS (No derating required up to 70°C)

CHARACTERISTIC		SYMBOL	RATING	UNIT	
LED	Forward Current (Each channel)	I _F	15	mA	
	Pulse Forward Current (Each channel)*	I _{FP}	30	mA	
	Reverse Voltage (Each channel)	V _R	5	V	
DETECTOR	Output Current (Each channel)	I _O	16	mA	
	Output Voltage (Each channel)	V _O	7	V	
	Supply Voltage (1 Minute Maximum)	V _{CC}	7	V	
	Output Collector Power Dissipation (Each channel)	P _o	MT26300	60	mW
			MT26310	40	
Operating Temperature Range		T _{opr}	0 ~ 70	°C	
Storage Temperature Range		T _{stg}	-55 ~ 125	°C	
Lead Solder Temperature (10 sec.)**		T _{sold}	260	°C	
Isolation Voltage (AC, 1 min., R.H. ≤ 60%, Note 8)		BV _S	2500	V _{rms}	

* t ≤ 1 msec Duration.

** 1.6mm below seating plane.

PHOTO IC COUPLER

T-41-89

ELECTRICAL CHARACTERISTICS (Ta=0°C ~ 70°C, Unless otherwise noted).

CHARACTERISTIC	SYMBOL	TEST CONDITION	MIN.	TYP.*	MAX.	UNIT
High Level Output Current (Each channel)	I _{OH}	V _{CC} =5.5V, V _O =5.5V I _F =250μA	—	1	250	μA
Low Level Output Voltage (Each channel)	V _{OL}	V _{CC} =5.5V, I _F =5mA I _{OL} (Sinking)=13mA	—	0.4	0.6	V
High Level Supply Current (Both channels)	I _{CCH}	V _{CC} =5.5V, I _F =0	—	14	30	mA
Low Level Supply Current (Both channels)	MT26300	I _{CCL}	V _{CC} =5.5V, I _F =10mA	—	24	36
	MT26310					
Input Forward Voltage (Each channel)	V _F	I _F =10mA, Ta=25°C	—	1.65	1.75	V
Input Reverse Breakdown Voltage (Each channel)	BV _R	I _R =10μA, Ta=25°C	5	—	—	V
Input Capacitance (Each channel)	C _{IN}	V _F =0, f=1MHz	—	45	—	pF
Input Diode Temperature Coefficient (Each channel)	$\frac{\Delta V_F}{\Delta T_a}$	I _F =10mA	—	-2.0	—	mV/°C
Input-Output Insulation Leakage Current	I _{I-O}	Relative Humidity=45% Ta=25°C, t=5 second V _{I-O} =3000V _{dc} (Note 8)	—	—	1	μA
Resistance (Input-Output)	R _{I-O}	V _{I-O} =500V (Note 8)	—	10 ¹²	—	Ω
Capacitance (Input-Output)	C _{I-O}	f=1MHZ (Note 8)	—	0.6	—	pF
Input-Input Leakage Current	I _{I-I}	Relative Humidity=45% t=5s, V _{I-I} =500V (note 9)	—	0.005	—	μA
Resistance (Input-Input)	R _{I-I}	V _{I-I} =500V (Note 9)	—	10 ¹¹	—	Ω
Capacitance (Input-Input)	C _{I-I}	f=1MHZ (Note 9)	—	0.25	—	pF
Current Transfer Ratio (Each channel)	MT26300 CTR	I _F =5mA, R _L =100Ω	—	1000	—	%

*All typical values are at V_{CC}=5V, Ta=25°C.

PHOTO IC COUPLER

T-41-89

SWITCHING CHARACTERISTICS (Ta=25°C, VCC=5V)

CHARACTERISTIC	SYMBOL	TEST CIRCUIT	TEST CONDITION	MIN.	TYP.	MAX.	UNIT
Propagation Delay Time to High Output Level	t_{pLH}	1	$R_L=350\Omega$, $C_L=15pF$ $I_F=7.5mA$ (Each channel, Note 2, 3, 4 & 5)	—	60	75	ns
Propagation Delay Time to Low Output Level	t_{pHL}			—	60	75	ns
Output Rise Time (10-90%)	t_r			—	30	—	ns
Output Fall Time (90-10%)	t_f			—	30	—	ns
Common Mode Transient Immunity at High Output Level	MT26300 C_{MH}	2	$V_{CM}=200V$, $R_L=350\Omega$ V_O (min.) =2V, $I_F=0mA$ (Each Channel, Note 7)	—	200	—	V/ μs
Common Mode Transient Immunity at Low Output Level	C_{ML}			—	-500	—	V/ μs
Common Mode Transient Immunity at High Output Level	MT26310 C_{MH}	3	$V_{CM}=400V$, $R_L=350\Omega$ V_O (min.) =2V, $I_F=0mA$ (Each Channel, Note 7)	1000	10000	—	V/ μs
Common Mode Transient Immunity at Low Output Level	C_{ML}			-1000	-10000	—	V/ μs

PHOTO IC COUPLER

T-41-89

MT26300

TEST CIRCUIT 1: t_{pHL} , t_{pLH}

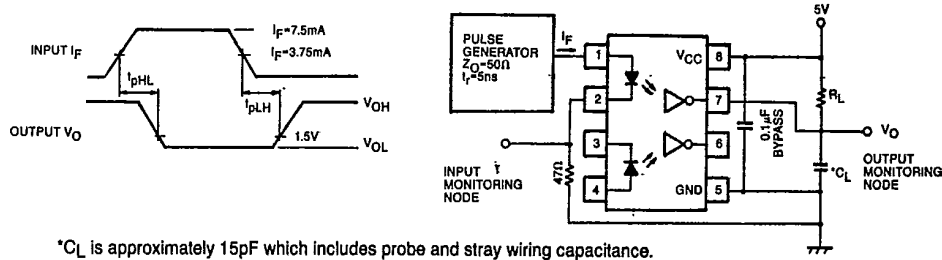

* C_L is approximately 15pF which includes probe and stray wiring capacitance.

MT26300

TEST CIRCUIT 2: TRANSIENT IMMUNITY AND TYPICAL WAVEFORMS

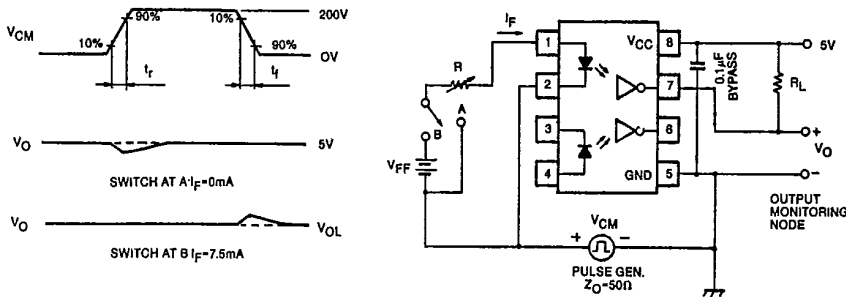
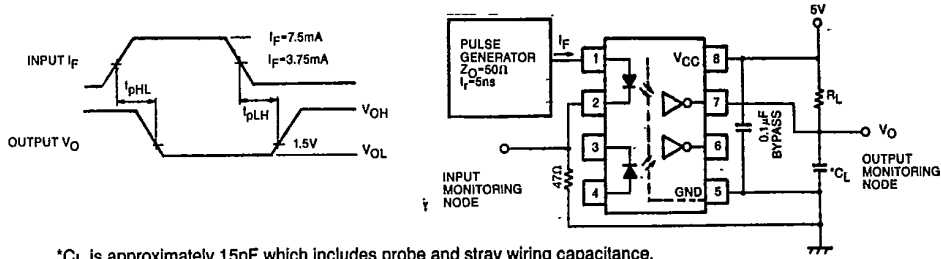

PHOTO IC COUPLER

T-41-89

MT26310
TEST CIRCUIT 1: t_{pHL} , t_{pLH}



* C_L is approximately 15pF which includes probe and stray wiring capacitance.

MT26310
TEST CIRCUIT 3: TRANSIENT IMMUNITY AND TYPICAL WAVEFORMS

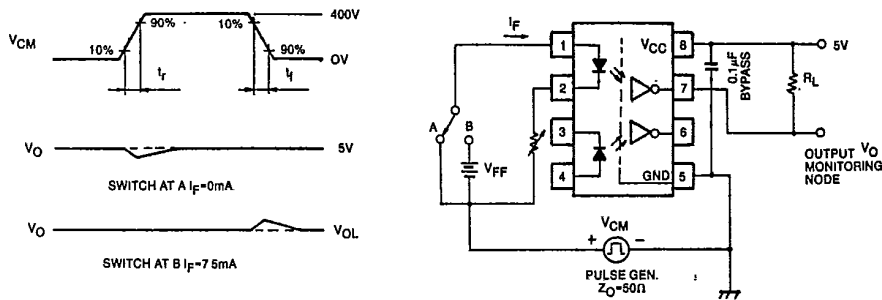

PHOTO IC COUPLER

T-41-89

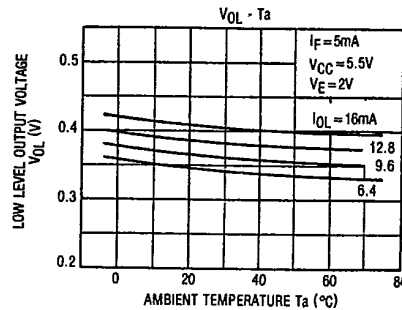
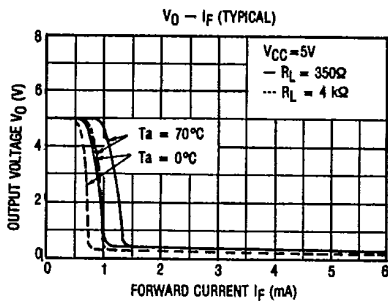
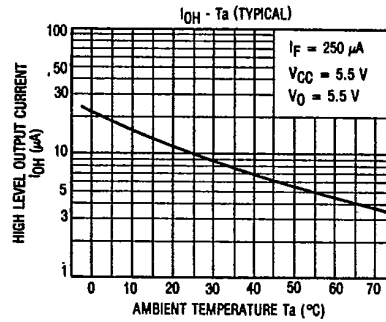
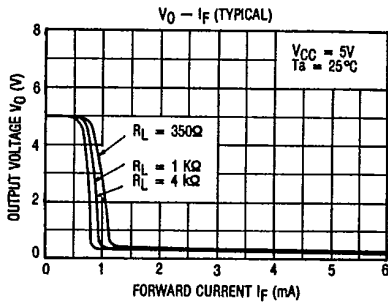
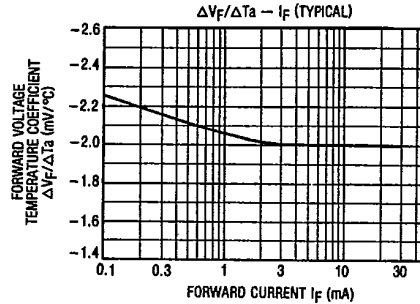
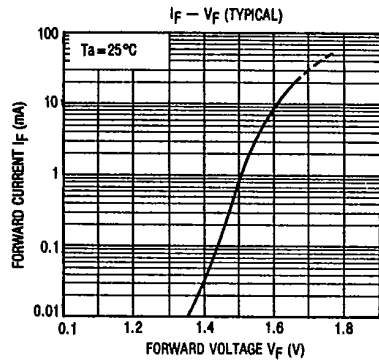

PHOTO IC COUPLER

T-41-89

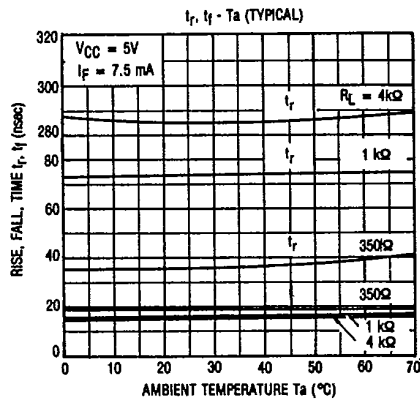
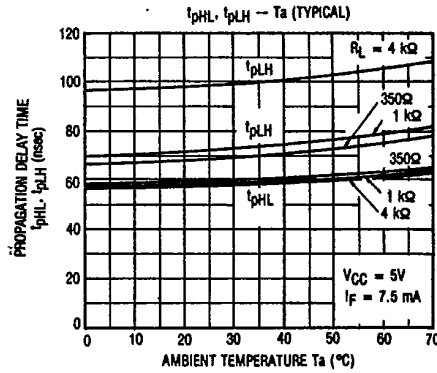
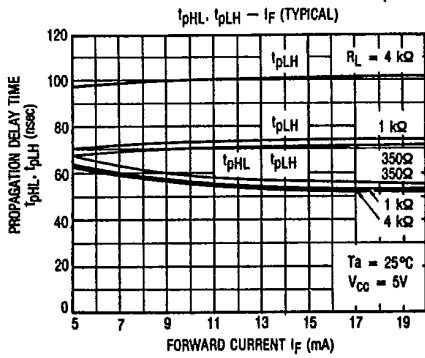

PHOTO IC COUPLER

T-41-89

NOTES:

1. The V_{CC} supply voltage to the MT26300 and MT26310 isolator must be bypassed by a $0.01\mu\text{F}$ capacitor or larger. This can be either a ceramic or solid tantalum capacitor with good high frequency characteristic and should be connected as close as possible to the package V_{CC} and GND pins in each device.
2. t_{pHL} — Propagation delay is measured from the 3.75mA level on the LOW to HIGH transition of the input current pulse to the 1.5V level on the HIGH to LOW transition of the output voltage pulse.
3. t_{pLH} — Propagation delay is measured from the 3.75mA level on the HIGH to LOW transition of the input current pulse to the 1.5V level on the LOW to HIGH transition of the output voltage pulse.
4. t_f — Fall time is measured from the 90% to the 10% levels of the HIGH to LOW transition on the output pulse.
5. t_r — Rise time is measured from the 10% to 90% levels of the LOW to HIGH transition on the output pulse.
6. CM_L — The maximum tolerable rate of fall of the common mode voltage to ensure the output will remain in the low output state (i.e., $V_{OUT} < 0.8V$). Measured in volts per microsecond ($V/\mu\text{s}$).
7. CM_H — The maximum tolerable rate of rise of the common mode voltage to ensure the output will remain in the high state (i.e., $V_{OUT} > 2.0V$). Measured in volts per microsecond ($V/\mu\text{s}$).
8. Device considered a two-terminal device: Pins 1, 2, 3 and 4 shorted together, and Pins 5, 6, 7 and 8 shorted together.
9. Measured between pins 1 and 2 shorted together, and pins 3 and 4 shorted together.