

## SFS5 Series AC-DC Converter Compact Miniature Type



PCB mount type



Chassis mount type

### Features

- UL, CB, CE Approved
- RoHS directive compliance
- Encapsulated, compact case
- High efficiency
- Universal input
- Surface mounting technology
- 100 kHz fixed frequency
- Fixed output voltage
- Thermal shutdown(IC-Temp: 150 °C)
- Low output ripple & noise
- Isolated input-output(3kVAC)
- Over voltage protection(O.V.P.)
- Over current protection(O.C.P.)
- Output short circuit protection
- Low no-load power consumption(0.3W Max.)
- 5Years warranty

### Environmental

- Operating temperature range: -10°C~70°C
- Storage temperature range: -20°C~80°C
- Humidity: 20%~90%RH
- Vibration: 10-55Hz at 10G(98m/s<sup>2</sup>), 3minutes period, 60minutes each one X, Y and Z axis
- Impact: 50G(490m/s<sup>2</sup>), 11ms, once each
- Cooling method: natural air convection

### Safety (single output)

- UL (UL60950-1, CSA C 22.2 NO. 60950-1)
- UL No: E227474
- CE (EN 60950-1) / CB (IEC 60950-1)

### Option

- Chassis mount type: Euro style terminal-block

### Description

The SFS5 Series has universal AC input and there are 5 models with single output and 2 models with dual outputs which are all available in two different pin assignments – PCB mount or Chassis mount. Super compact size with elegant design and high reliability are achieved. CEC compliant design shows high efficiency and low no-load power consumption. A limited EMI filter is included and an additional EMI filter to input side is required to meet CISPR22-B EMI Standard.

## SFS5 Series AC-DC Converter Compact Miniature Type

Electrical specifications		
INPUT	Voltage	AC85~264V (or DC 110~340V) 50/60Hz (note)
	Current	0.15A Max. @ 110VAC / 0.08A Max. @ 220VAC
	Frequency	47~440Hz Max. (50~60Hz typ.)
	Efficiency	75% Typ.
	Inrush current (at cold start)	20A Max. @ 120VAC. / 40A Max. @ 240VAC
	Leakage current	0.5mA Max. @ 110VAC / 0.75mA Max. @ 220VAC

OUTPUT	Voltage tolerance (accuracy)	±2% Max (single and uncomplementary dual). ±3% Max (complementary dual).
	Ripple and noise	±1% Typ.
	Line regulation	±1% Typ.
	Load regulation	±1% Typ.@output1 , ±2% Typ.@output2
	Dynamic load regulation	±3% Typ.@output1
	Temperature regulation	±1% Typ.
	No-load power consumption	0.3W Max.
	Rising time	100ms Max.
	Hold up time	10ms Min.

Protection circuit	
Over voltage protection	Clamp, 130~150%
Over current protection	Works at over 105% of rating & recovers automatically
Over temperature protection	150°C Latching, Recovering

Isolation specifications	
Isolation Resistance	DC 500V, 100MOhms Min.
Input-Output Isolation Voltage	AC 3KV, 1minute, 10mA.

General specifications	
Switching frequency	100kHz
Calculated MTBF	4.5*10 <sup>5</sup> hrs
Weight	40g or less

NOTE: For cases that conform various safety specifications(UL, CSA, CE, CB etc). It require input voltage and frequency range will be 100~240Vac, 50~60Hz.

SFS5 Series AC-DC Converter Compact Miniature Type

Ordering information

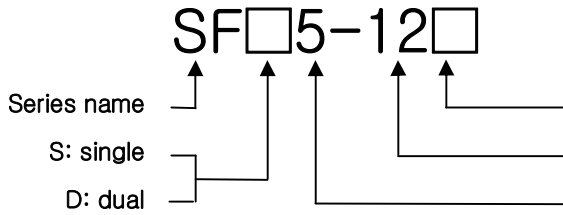

If chassis mount type, 'C' added  
Output voltage  
Output power

Input	Output1	Output2	Maximum power	Ripple & Noise	Efficiency typical	Model number
AC85~264V or DC110~340V	3.3V@1.25A		4.125W	80mVp-p	68%	SFS5-3R3
	5V@1.0A		5.0W	80mVp-p	75%	SFS5-5
	12V@0.42A		5.0W	120mVp-p	77%	SFS5-12
	15V@0.33A		5.0W	150mVp-p	77%	SFS5-15
	24V@0.21A		5.0W	200mVp-p	77%	SFS5-24
	+12V@0.21A	-12V@0.21A		5.0W	120/120mVp-p	72%
	+15V@0.17A	-15V@0.17A	5.0W	150/150mVp-p	72%	SFD5-1515

Pin assignments

- |               |             |
|---------------|-------------|
| Single output | Dual output |
| 1. AC(N)      | 1. AC(N)    |
| 2. AC(L)      | 2. AC(L)    |
| 3. No pin     | 3. -V       |
| 4. -V         | 4. GND      |
| 5. +V         | 5. +V       |

Derating curve

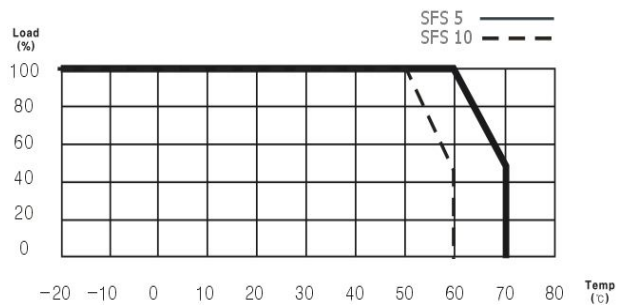

Dimensions

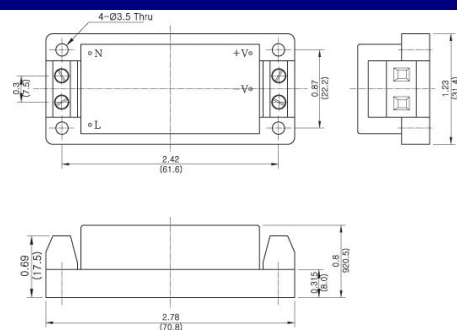
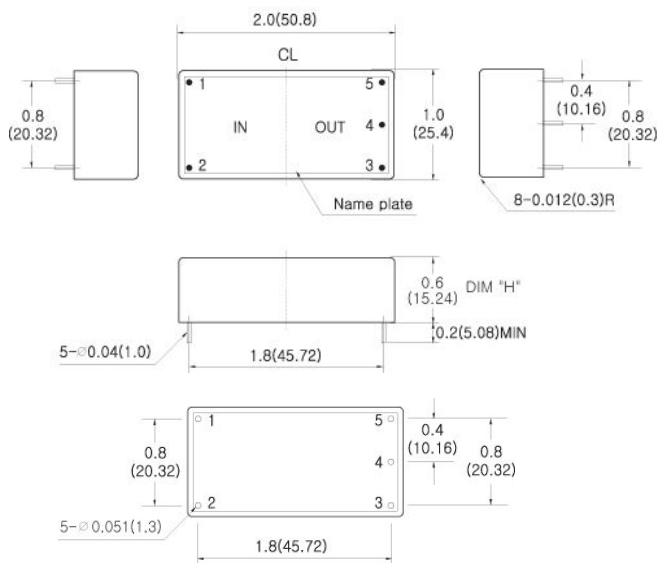

NOTES

- All dimensions are inch(mm).
  - Weight : 40g or less
  - Case material : PBT, 94V-0 Rated
  - Construction : encapsulated, Soft Pot
  - Dimension "H"
- 0.6(15.24) for 5watt / SFS5,SFD5 version

## SFS5 Series AC-DC Converter Compact Miniature Type

### Inrush Current

#### TEST CONDITION

- 240Vac input
- Full load output
- PHASE 90°input start, current measure

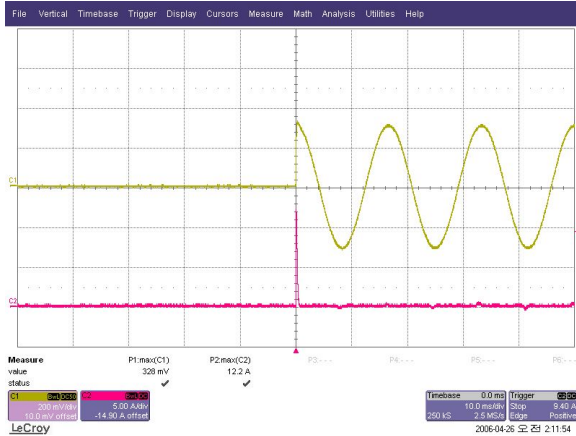

SFS5-3R3 12.2A

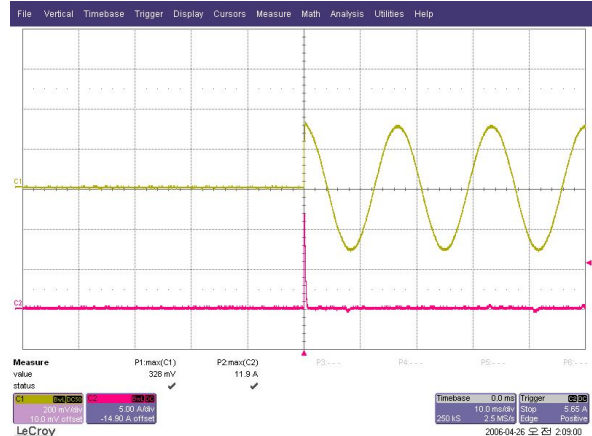

SFS5-5 11.9A

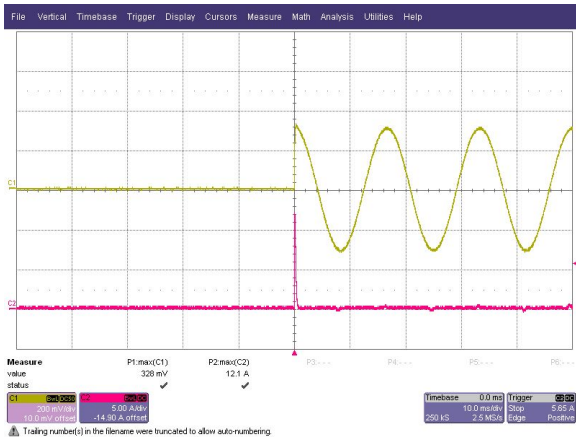

SFS5-12 12.1A

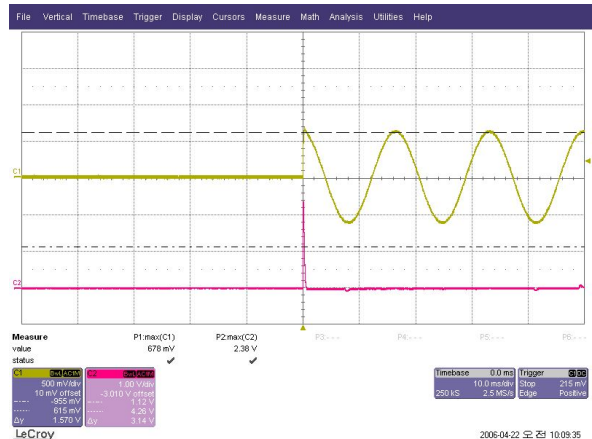

SFS5-15 11.9A

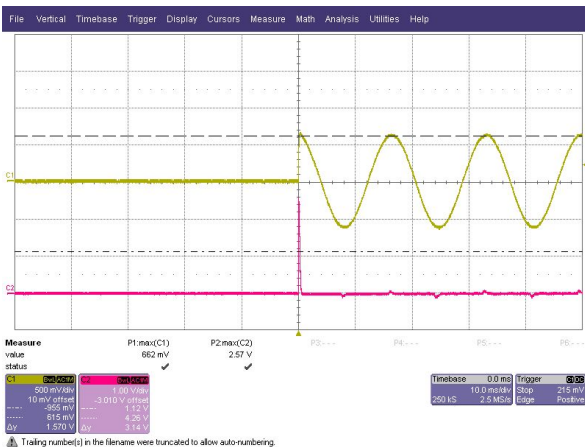

SFS5-24 12.85A

Inrush current concerns wrong to fuse, input rectifier, power-switch, circuit break and parts. It degrades the another circuit voltage and occurs system error. If you defuse inrush current. You add NTC or Inrush current limiter to external circuit.

High rating voltage input

Max20A @ 120Vac

Max40A @ 240Vac

## SFS5 Series AC-DC Converter Compact Miniature Type

### Rising Time

#### TEST CONDITION

- 220Vac Input
- Full Load Output
- Output Voltage 10% ~ 90% Rising Time Measure

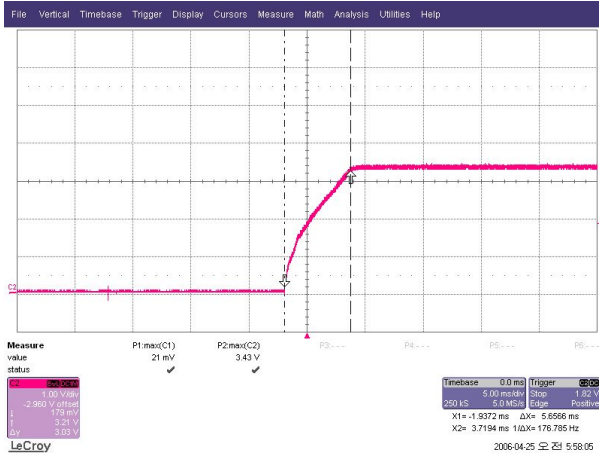

SFS5-3R3 5.66ms

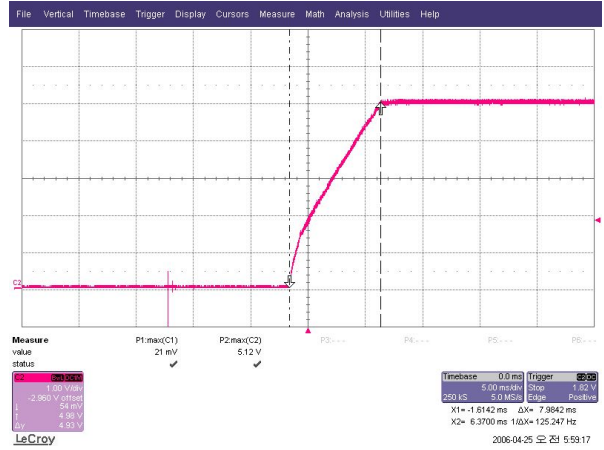

SFS5-5 7.98ms

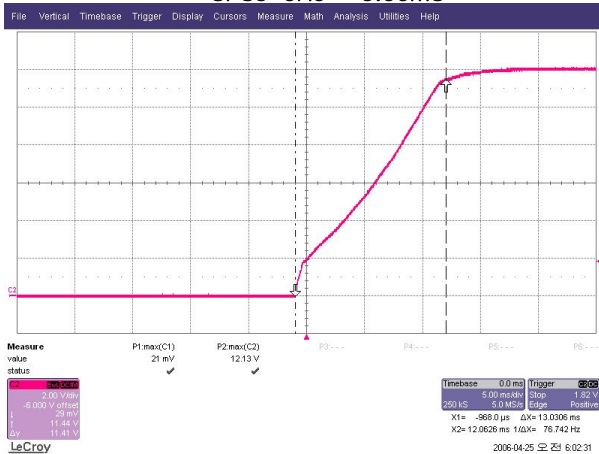

SFS5-12 13.0ms

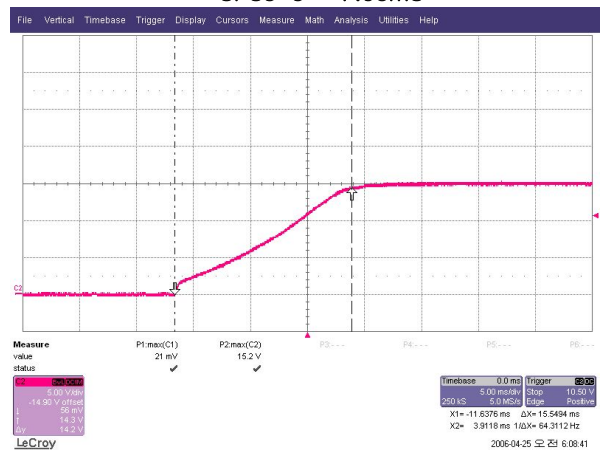

SFS5-15 15.6ms

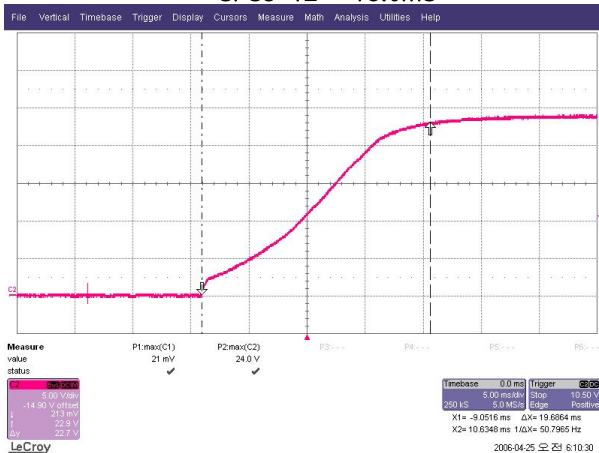

SFS5-24 19.7ms

Max 100ms between output voltage 0%~90%

## SFS5 Series AC-DC Converter Compact Miniature Type

### Hold up Time

#### TEST CONDITION

- 220Vac Input
- Full Load Output
- When Input off Phase 360°, Output Voltage off Time Measure

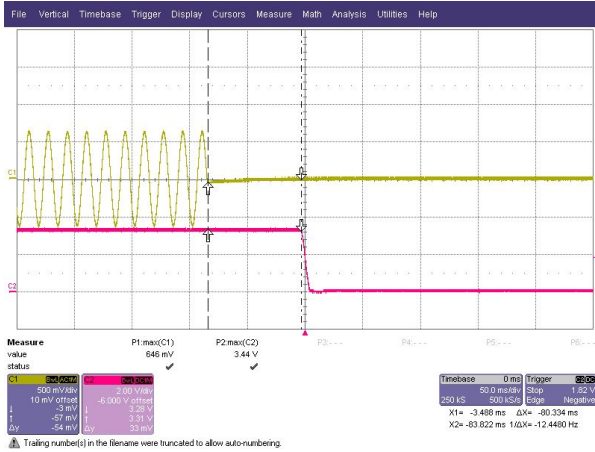

SFS5-3R3 80ms

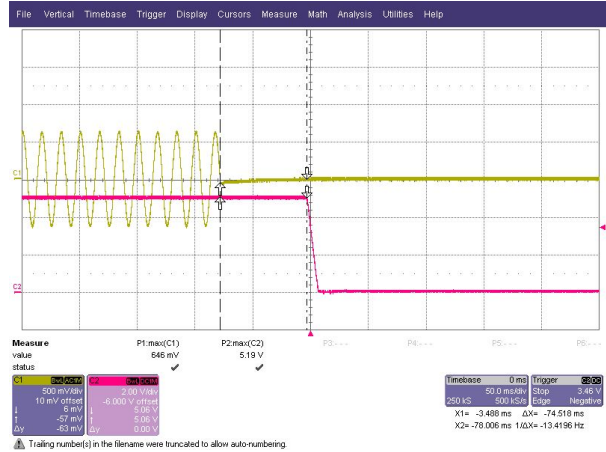

SFS5-5 75ms



SFS5-12 75ms

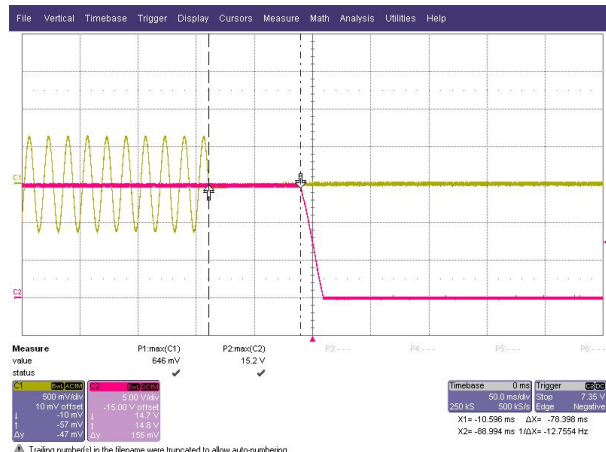

SFS5-15 78ms

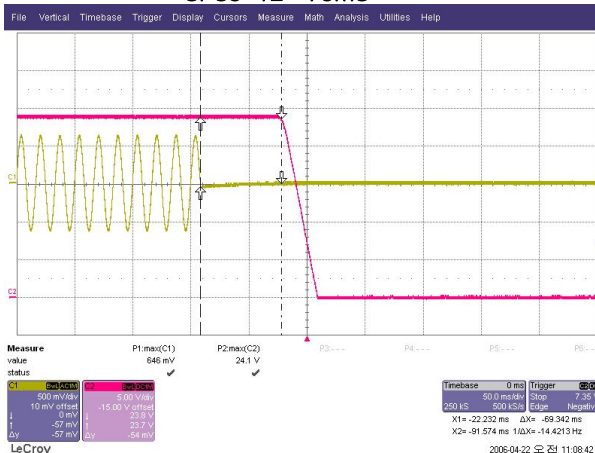

SFS5-24 69ms

The amount of time that a power supply's output-voltage remains within the specified-voltage ranges after it's input voltage interrupts.

Low rating voltage

Min10ms @100Vac

## SFS5 Series AC-DC Converter Compact Miniature Type

### Start up Time

#### TEST CONDITION

- 220Vac Input
- Full Load Output
- When Input on Phase 360°, Output Voltage 100% rise Time Measure

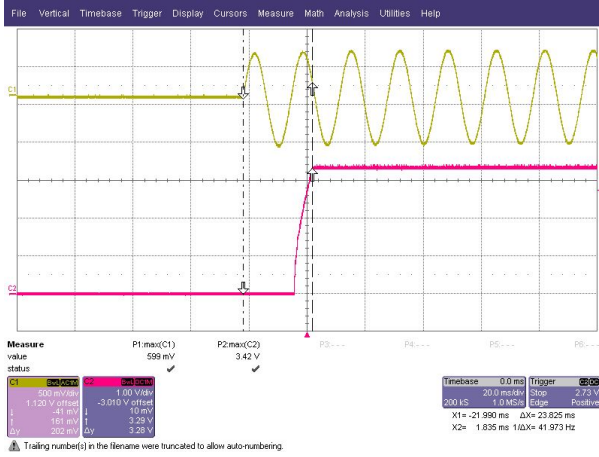

SFS5-3R3 23.8mS

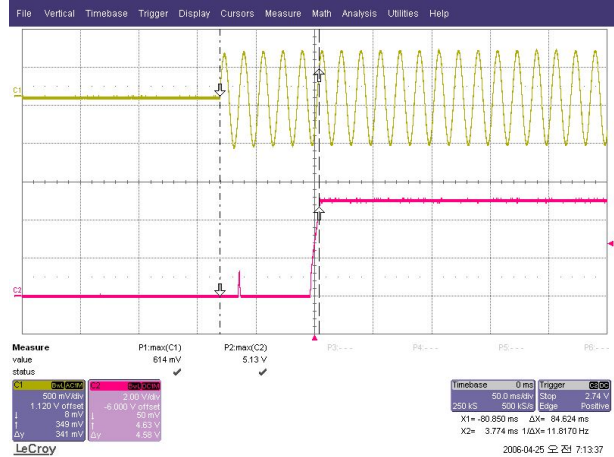

SFS5-5 84.6mS

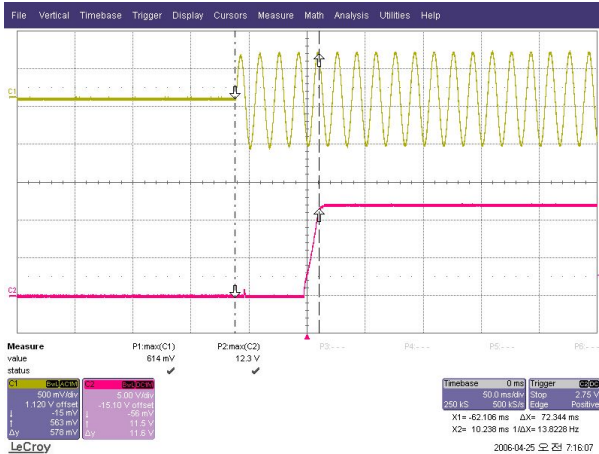

SFS5-12 72.3mS

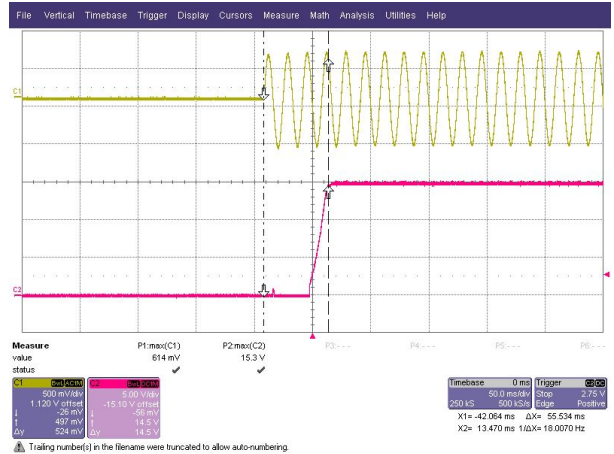

SFS5-15 55.5mS

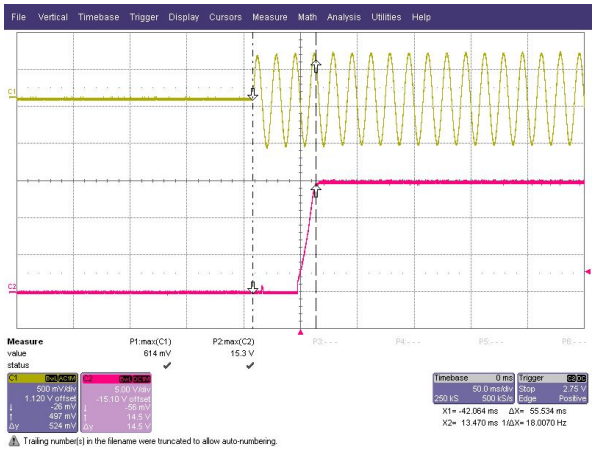

SFS5-24 32.9mS

Amount of delay time and rise time. After input-voltage injects.

## SFS5 Series AC-DC Converter Compact Miniature Type

### Dynamic Load

#### TEST CONDITION

- 220Vac Input
- 0% Load ~ 100% Load Output
- Freq. : 100Hz , - Duty : 0.5

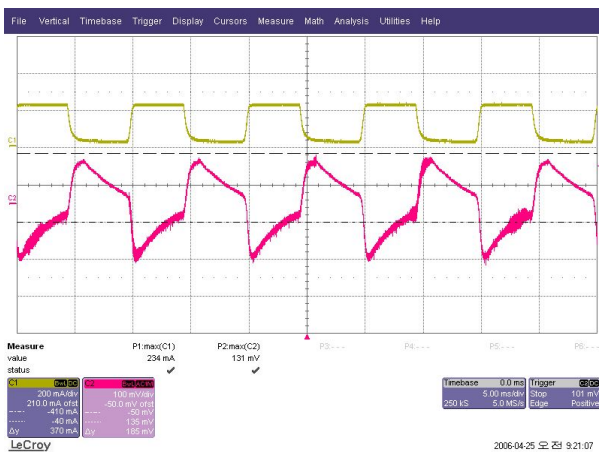
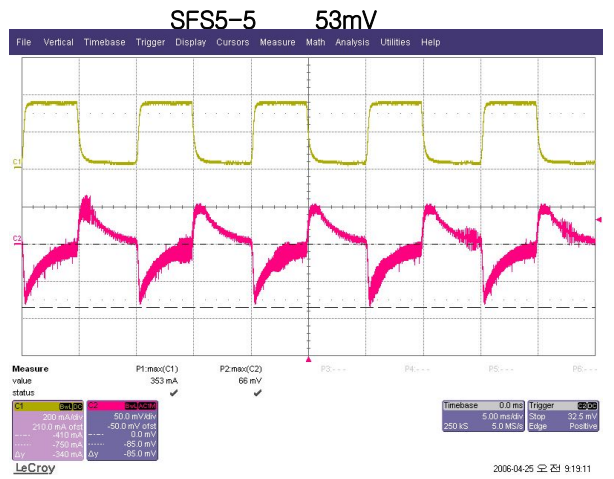
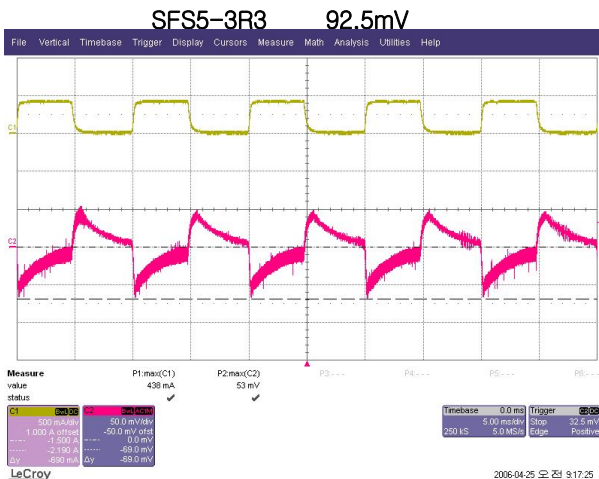
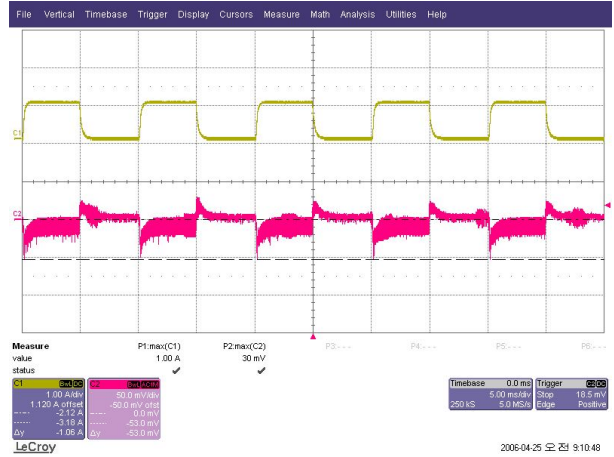
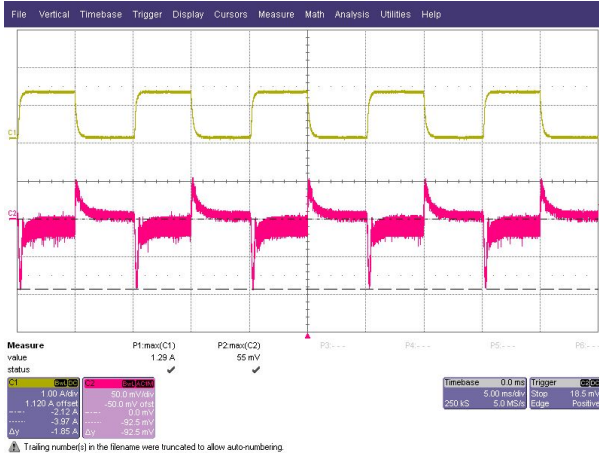

SFS5-3R3 92.5mV

SFS5-5 53mV

SFS5-12 69mV

SFS5-15 85mV

SFS5-24 135mV

Considerate slew rate and frequency within  $\pm 3\%$  output voltage value.



## SFS5 Series AC-DC Converter Compact Miniature Type

### Over Shoot

TEST CONDITION

- 220Vac Input
- Full Load Output

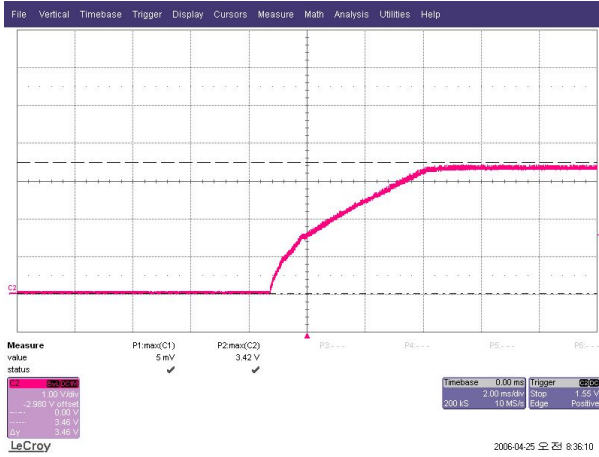

SFS5-3R3 0V

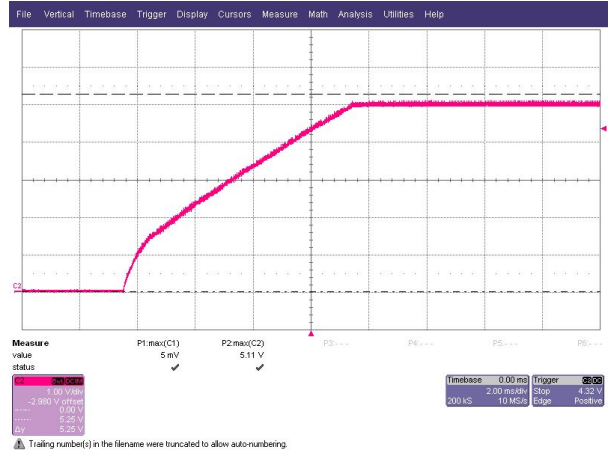

SFS5-5 0V

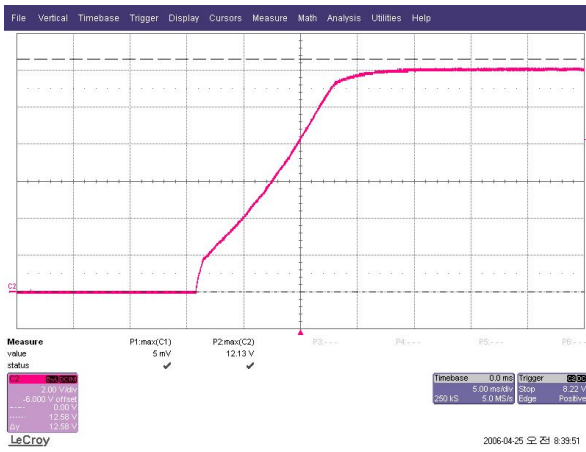

SFS5-12 0V

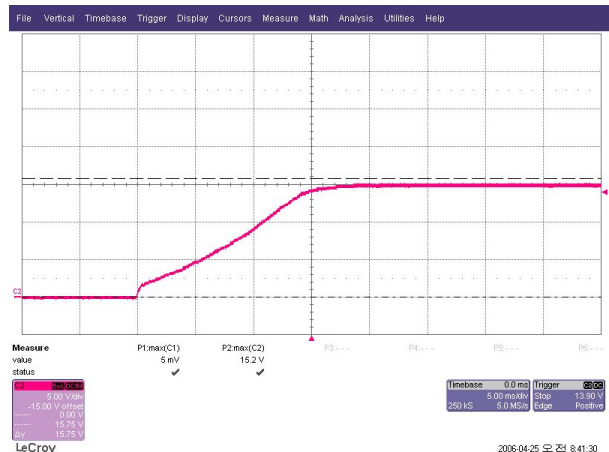

SFS5-15 0V

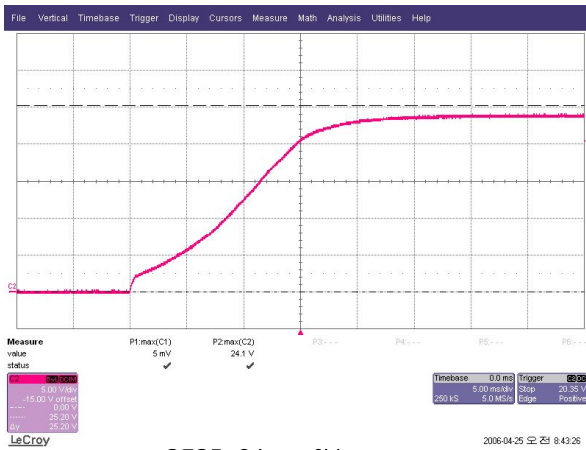

SFS5-24 0V

When turn-on, the output overshoot voltage shall not exceed 5% of normal Voltage value no Load or full Load connected.

## SFS5 Series AC-DC Converter Compact Miniature Type

### Output Ripple & Noise

#### TEST CONDITION

- 220Vac Input
- Full Load Output
- Ele-cap(47uF)and Ceramic-cap(104), Output Terminal



SFS5-3R3 51.6mVpp

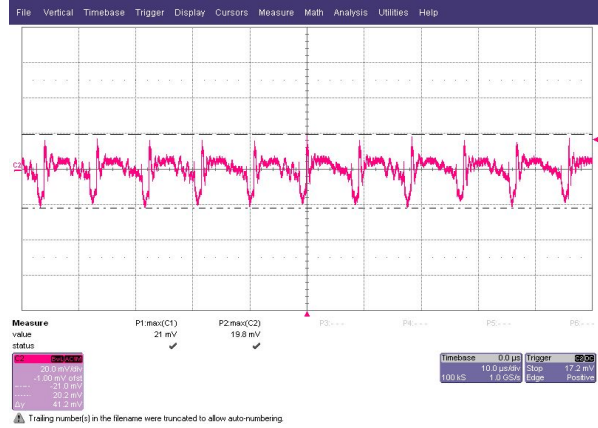

SFS5-5 41.2mVpp

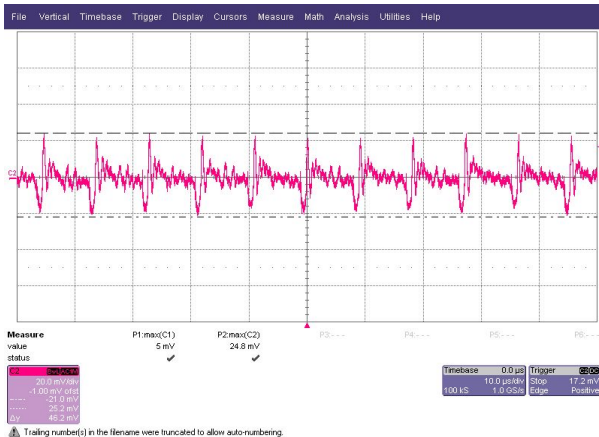

SFS5-12 46.2mVpp

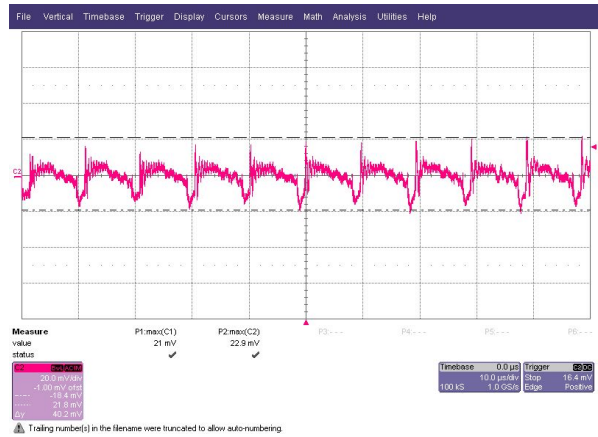

SFS5-15 40.2mVpp



SFS5-24 74.6mVpp

\*Ripple & Noise: Oscilloscope bandwidth 20MHz.  
The length of the output line should be shorter than 1meter and it needs to be twisted.

SFS5 Series AC-DC Converter Compact Miniature Type

Efficiency Curve(Load Variation)

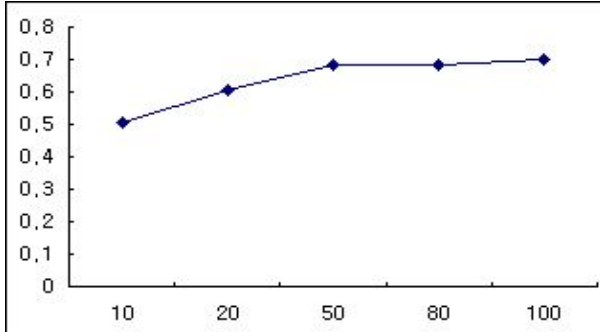

Load(%)	10	20	50	80	100
Eff(%)	50.8%	60.6%	68.2%	68.6%	70.0%

SFS5 - 3R3

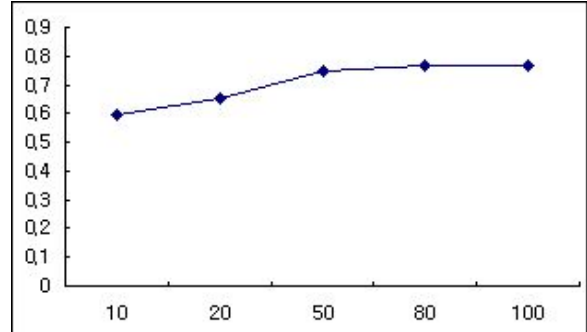

Load(%)	10	20	50	80	100
Eff(%)	59.5%	65.0%	74.6%	76.5%	76.8%

SFS5 - 5

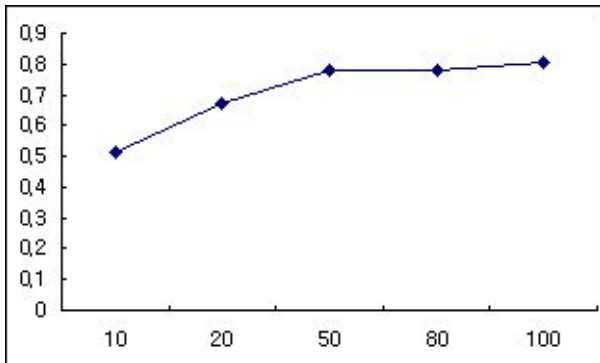

Load(%)	10	20	50	80	100
Eff(%)	51.4%	66.9%	77.7%	77.8%	80.2%

SFS5 - 12

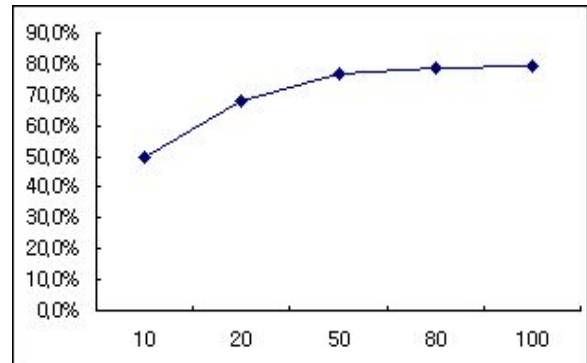

Load(%)	10	20	50	80	100
Eff(%)	50.0%	68.1%	76.5%	78.7%	79.5%

SFS5 - 15

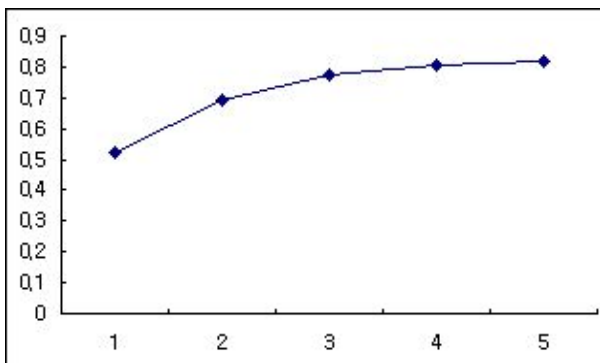

Load(%)	10	20	50	80	100
Eff(%)	52.1%	69.0%	77.5%	80.5%	81.6%

SFS5 - 24

Input 220Vac, Variation of efficiency,  
from minimum load to maximum load.

SFS5 Series AC-DC Converter Compact Miniature Type

Efficiency Curve(Input Voltage Variation)

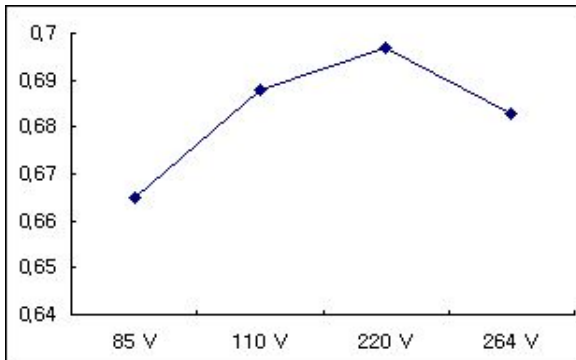

Input (V)	85 V	110 V	220 V	264 V
Eff(%)	66.5%	68.8%	69.7%	68.3%

SFS5 - 3R3

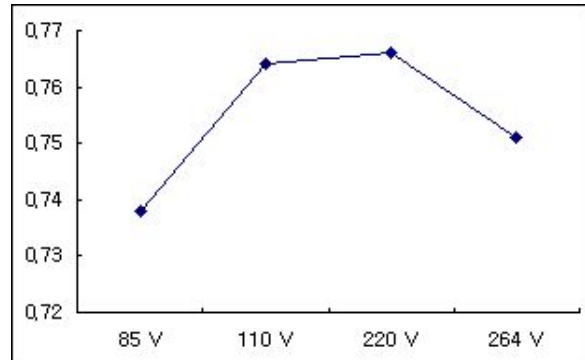

Input (V)	85 V	110 V	220 V	264 V
Eff(%)	73.8%	76.4%	76.6%	75.1%

SFS5 - 5

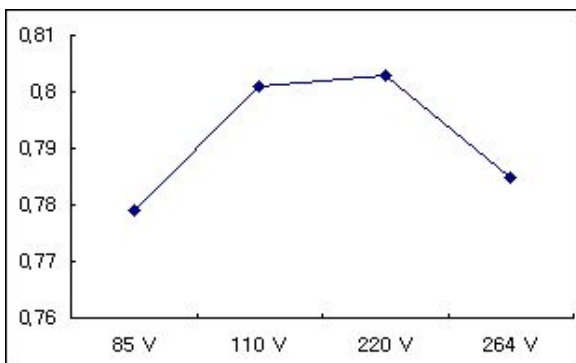

Input (V)	85 V	110 V	220 V	264 V
Eff(%)	77.9%	80.1%	80.3%	78.5%

SFS5 - 12

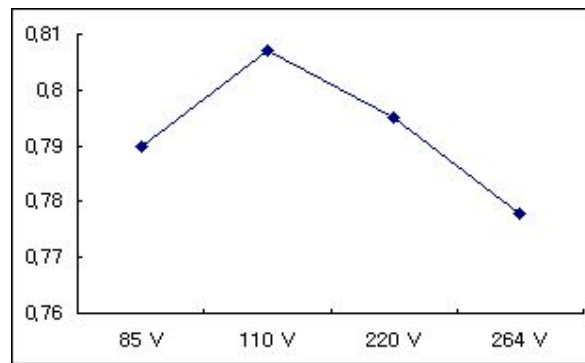

Input (V)	85 V	110 V	220 V	264 V
Eff(%)	79.0%	80.7%	80.7%	77.8%

SFS5 - 15

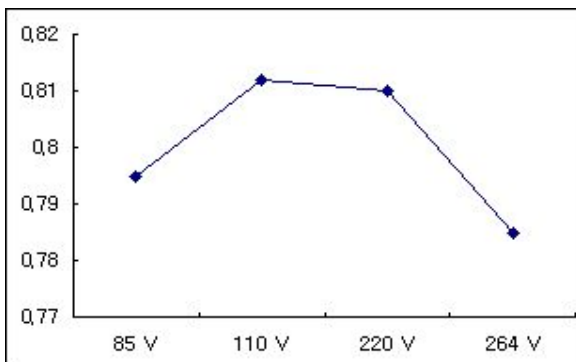

Input (V)	85 V	110 V	220 V	264 V
Eff(%)	79.5%	81.2%	81.0%	78.5%

SFS5 - 24

Variation of Efficiency, from Minimum input Voltage to Maximum input Voltage

SFS5 Series AC-DC Converter Compact Miniature Type

**No-Load Power Consumption**

No load power consumption is the power used by a device, when it is disconnected from its load and performing no function. SFS5 series are very low no-load power consumption (single output).

RATED OUTPUT POWER	NO-LOAD POWER CONSUMPTION		
	PHASE 1 01.01.2001	PHASE 2 01.01.2003	PHASE 3 01.01.2005
≥ 0.3W and < 15W	1.0W	0.75W	0.3W
≥ 15W and < 50W	1.0W	0.75W	0.5W
≥ 50W and < 75W	1.0W	0.75W	0.75W

Source : European commission code of conduct on efficiency of external power supplies(06.15.2000)

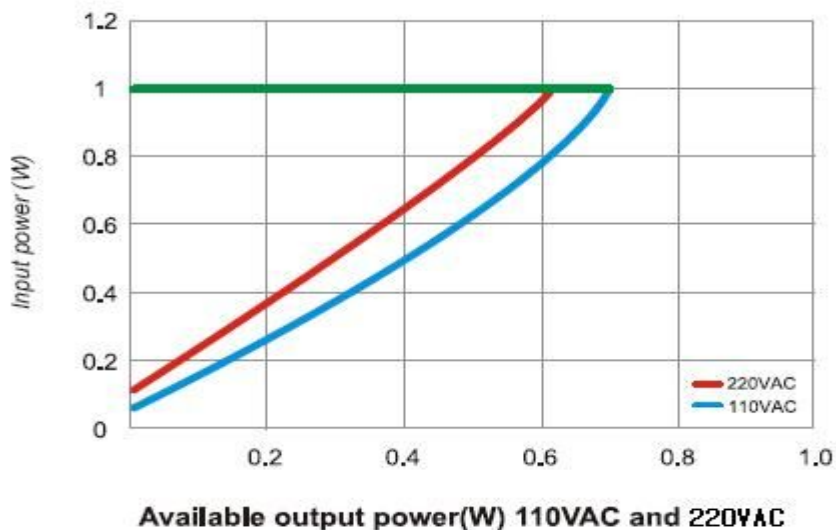

## SFS5 Series AC-DC Converter Compact Miniature Type

### Thermal Test

After power supply SFS5 Series was molded, and Components Thermal measurement. Operating the power supply At normal temperature. Until the temperature of components is saturated. Maximum permitted degree of components ascertains the margins. We will calculate the maximum operation degree. Degree of ambient temperature rises up and load derates.

Test Voltage(V), 60Hz	90VAC	$\Delta$ °C	254VAC	$\Delta$ °C	REMARK
Tamb	24.6		24.9		
Temperature T of part					
1. 5Vdc F1 Body	42.8	18.2	43.5	18.6	
2. L1 Body	38.7	14.1	37.6	12.7	
3. C1 Body	40.3	15.7	40.5	15.6	
4. D1	45.4	20.8	45.4	20.5	
5. Transformer coil	47.2	22.6	50.7	25.8	
6. Transformer core	46.5	21.9	50.0	25.1	
7. Inside Enclosure	44.8	20.2	47.6	22.7	
8. Outside Enclosure	42.0	17.4	44.0	19.1	
9. 3.3Vdc Transformer coil	47.0	22.4	50.0	25.1	
10. Transformer core	47.1	22.5	50.3	25.4	
11. 12Vdc Transformer coil	47.4	22.8	48.6	23.7	
12. Transformer core	46.6	22.0	47.2	22.3	
13. 15Vdc Transformer coil	46.7	22.1	51.7	26.8	
14. Transformer core	46.2	21.6	51.0	26.1	
15. 24Vdc Transformer coil	44.3	19.7	48.4	23.5	
16. Transformer core	42.2	17.6	45.4	20.5	
17. Ambient	24.6	0.0	24.9	0.0	

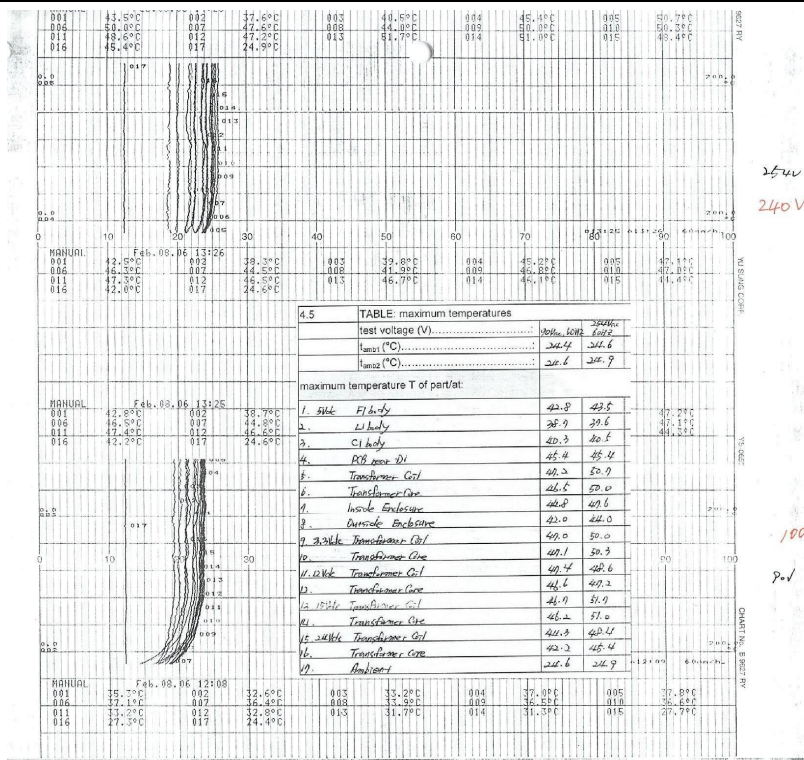

## SFS5 Series AC-DC Converter Compact Miniature Type

### Electro Magnetic Interference Application.

SFS5 Series are needed to reduce Electromagnetic Interference, use the external L-C noise filter at the input of the Converter.

#### 1. Configuration

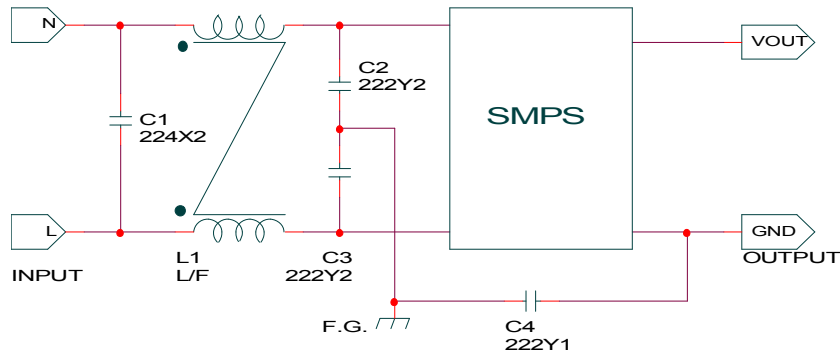

#### 2. Components

L1 = 10~30mH Common Mode Line Filter

C1 = 220nF X2 Capacitor

C2,C3 = 2200pF Y2 Capacitor

C4 = 2200pF Y1 Capacitor

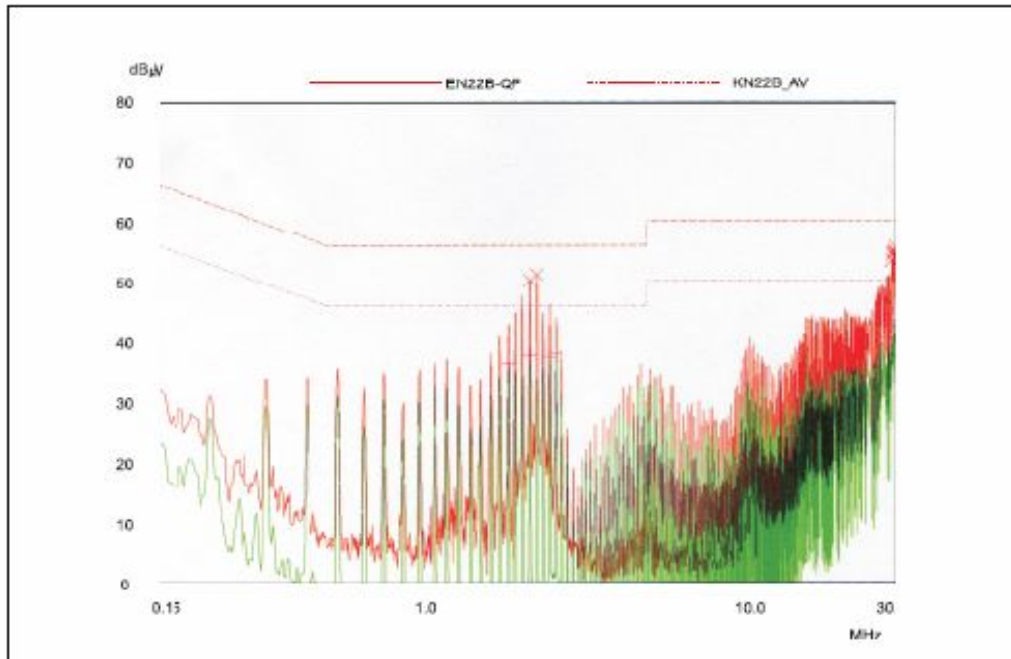

The CISPR 22 Standard @ SFS5-12

## SFS5 Series AC-DC Converter Compact Miniature Type

DRIFT							
No	Time	Voltage(V)					Remarks
		3.3V	5V	12V	15V	24V	
		1.25A	1.0 A	0.42 A	0.33 A	0.21A	Vin 220VAC
1.	08:30	3.314	5.024	12.100	14.999	24.010	
2.	09:00	3.310	5.022	12.077	14.996	23.980	
3.	09:30	3.307	5.020	12.068	14.999	23.980	
4.	10:00	3.304	5.019	12.067	15.000	23.990	
5.	10:30	3.304	5.020	12.068	14.999	23.990	
6.	11:00	3.306	5.020	12.070	14.999	23.990	
7.	11:30	3.307	5.019	12.066	15.000	23.990	
8.	12:00	3.306	5.020	12.068	14.999	23.990	
9.	12:30	3.303	5.020	12.068	14.999	23.990	
10.	13:00	3.306	5.020	12.067	14.998	23.990	
11.	13:30	3.306	5.020	12.067	14.999	23.990	
12.	14:00	3.304	5.020	12.062	14.998	23.990	
13.	14:30	3.305	5.020	12.069	14.998	23.990	
14.	15:00	3.306	5.020	12.070	14.997	23.990	
15.	15:30	3.306	5.019	12.064	14.998	23.990	
16.	16:00	3.305	5.019	12.068	14.999	23.990	
17.	16:30	3.304	5.020	12.062	14.998	23.990	
18.	17:00	3.306	5.020	12.063	14.998	23.990	

1. Primary Drift: (Maximum Value - Datum Value) ÷ Datum V × 10<sup>6</sup> (Power On ~ 30minute)

3.3V	1208.45921	PPM
5 V	398.24771	PPM
12 V	1904.44647	PPM
15 V	200.053348	PPM
24V	1251.04254	PPM

2. Passage Drift: (Max Value - Datum Value) ÷ Datum V × 10<sup>6</sup> (30Minutes ~ Until 8hours 30minutes)

3.3V	-2114.8036	PPM
5 V	-398.24771	PPM
12 V	-1242.0303	PPM
15 V	266.737797	PPM
24V	417.014178	PPM
(Maximum Value - Minimum Value)		
3.3V	0.007	V : 0.2%
5 V	0.003	V : 0.06%
12 V	0.015	V : 0.125%
15 V	0.004	V : 0.03%
24V	0.01	V : 0.04%



## SFS5 Series AC-DC Converter Compact Miniature Type

### Calculating Reliable Values of MTBF

#### 1. Calculating method

Calculated based on part count reliability projection of MIL-HDBK-217F Individual failure rates  $\lambda_g$  is given to each part and MTBF (Mean Time Between Failure) is calculated by the count of each part.

<Formula>:

$$MTBF = 1 / \lambda_{\text{equip}} = 1 / \left( \sum_{i=1}^n N_i (\lambda_G \Pi_Q)_i \right) * 10^6 \text{ (Hours)}$$

$\lambda_{\text{equip}}$  : Total Equipment Failure Rate (Failure/10<sup>6</sup>Hours)

$\lambda_G$  : Generic Failure Rate for The ith Generic Part (Failure/ 10<sup>6</sup>Hours)

$\Pi_Q$  : Generic Quality Factor for The ith Generic Part ( $\Pi_Q=1$ )

$N_i$  : Quantity of ith Generic Part

$n$  : Number of Different Generic Part Categories

#### 2. MTBF Values

MTBF  $\approx$  484,937(Hours)

PART	Number	Failure Rate	Failure Rate*n	Remark
	n	$\lambda_G(F/T)$	$\lambda_G \times n(F/T)$	
Logic IC	1	0.01500	0.01500	Separate
Transistor, FET	1	0.09900	0.09900	Separate
Diode	6	0.02200	0.13200	
Voltage Regulator	1	0.02400	0.02400	
Photo-coupler	1	0.07000	0.07000	
Diode Bridge	1	0.06600	0.19800	*3
Ele-capacitor	3	0.01900	0.05700	
Ceramic Capacitor	1	0.02600	0.02600	
MLCC	7	0.05300	0.37100	
Choke coil	1	0.00022	0.00022	
Switching trans	1	0.00420	0.00420	
Line Filter	2	0.00440	0.00880	
Resistor Chip	7	0.01600	0.11200	
Connector	5	0.05200	0.26000	
Reflow soldering	45	0.00014	0.00630	
Flow soldering	37	0.00780	0.28860	
PCB	1	0.37000	0.37000	SMT
Fuse	1	0.02000	0.02000	
Total Equipment Failure Rate $\lambda_G \times n(F/T)$			2.06212	
MTBF = $10^6 / \lambda_G(F/T)$			484937.831	

## SFS5 Series AC-DC Converter Compact Miniature Type

Reliability Specification	Standard	Remarks
Dry heat	IEC60068-2-2	
Cold	IEC60068-2-1	
Thermal shock	IEC60068-2-14	
Temperature, humidity cycle	IEC60068-2-30, IEC60068-2-38	
Vibration	IEC 60068-2-6	
Mechanical shock	IEC 60068-2-27	
Electrostatic Discharge immunity	IEC 61000-4-2	
Immunity to radio frequency EM-fields	IEC 61000-4-3	
Electrical fast transient/burst immunity	IEC 61000-4-4	
Surge immunity	IEC 61000-4-5	
B10 Life test	B10 Life is the time by which 10% of the product population will get failed	

## SFS5 Series AC-DC Converter Compact Miniature Type

### Instruction manual

#### 1. Basic connection

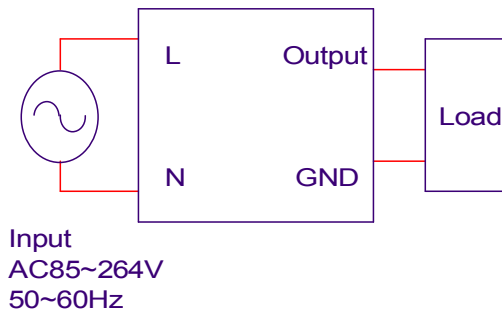

NOTE: To avoid excessive voltage drop and for improved noise, and short and thick wire should be used to connect the load. Length below 50cm & wire thickness of  $4.0\text{A}/\text{mm}^2$  are recommended for reducing wire loss when wire connection is necessary.

#### 2. Parallel Operation

This supply can be operated the following ways.

Choose a diode in accordance with voltage, power dissipation and heat radiation.

- Voltage :  $V > V_o \times 3$
- Current :  $I > I_o \times 3$
- Design a proper heat sink according to power loss at diode (  $P_w = V_F \times I_o$  )
- Use a schottky or fast recovery diode this has a low  $V_F$ .

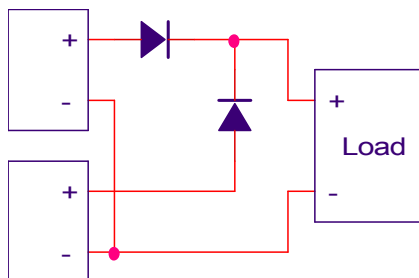

#### 3. Series Operation

Choose a diode in accordance with voltage, power dissipation and heat radiation.

- Voltage :  $V > V_o \times 3$
- Current :  $I > I_o \times 3$
- Design a proper heat sink according to power loss at diode (  $P_w = V_f \times I_o$  ).
- Use a schottky or fast recovery diode this has a low  $V_F$ .

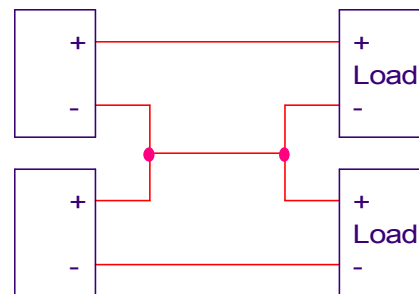
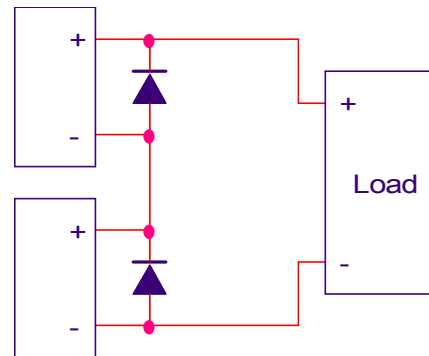

#### 4. Over Current Protection

Output current is grown, this is mainly due to the poor coupling between the auxiliary winding and the power winding. Which prevents proper collapsing. When  $V_{out}$  goes low.

## SFS5 Series AC-DC Converter Compact Miniature Type

### Instruction manual

#### 5. Over Voltage Protection

SFS series are equipped with an over-voltage protection circuit by zener diode. If zener diode is opened, Vcc rise up, it becomes possible to implement an over voltage protection. Ratch on mode. If zener diode is short, output is shorted.

It becomes possible to implement a short circuit Protection.

#### 6. Over Temperature Protection

Temperature protection is provided by a precision analog circuit that turns the output MOSFET off when the junction temperature exceeds the thermal shutdown temperature (130°C Min. , 140°C Typ. and 70°C hysteresis). When the junction temperature cools to below the hysteretic temperature, normal operation resumes providing automatic recovery.

#### 7. Line Regulation

Maximum line regulation is maximum output voltage change when the input volt is slowly varied with in the input voltage range.

#### 8. Load Regulation

Maximum load regulation is maximum output voltage value change when varying the load current slowly within the standard output current range.

#### 9. Isolation Resistance

The isolation resistance is more than 100MΩ at 500 VDC when tested with DC isolation between the output and the case. Make sure that during testing, the isolation tester does not produce a high pulse when the applied voltage is varied. Ensure that the tester is fully discharged after the test.

#### 10. Withstand Voltage

SFS5 series are designed to withstand 3KVAC (10mA) 1 minute between input output for the withstand voltage test, the applied voltage must be increased gradually from zero to the testing value, and then decreased gradually at shut down. Especially stay away from use of a timer. Where a pulse of several times the applied voltage can be generated.

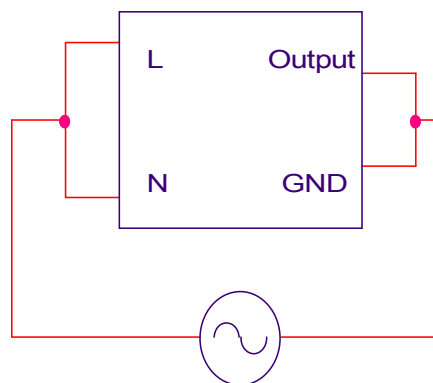

#### 11. No-Load Power Consumption

No-Load power is the energy used by a device when it is disconnected from it's load and performing no function.

#### 12. Short Circuit Protection

By permanently monitoring the feedback line activity, the IC is able to detect the presence of a short-circuit. Immediately reducing the output power for a total system protection. Once the short has disappeared, the controller resumes and goes back to normal operation.

SFS5 Series AC-DC Converter Compact Miniature Type

Instruction manual

13. Block Diagrams

Circuit topology : Flyback

Switching frequency : 100KHz(fixed)

