

# Power TOPLED® with Lens Enhanced Optical Power LED (ATON®)

LB E63C, LV E63C, LT E63C



## Vorläufige Daten / Preliminary Data

### Besondere Merkmale

- **Gehäusertyp:** weißes P-LCC-4 Gehäuse
- **Besonderheit des Bauteils:** fokussierte Abstrahlung in SMT-Technologie; hohe Helligkeit in Achsrichtung; höhere Umgebungstemperatur bei gleichem Strom im Vergleich zur TOPLED® möglich
- **Wellenlänge:** 469 nm (blau), 503 nm (verde), 525 nm (true green)
- **Abstrahlwinkel:** 20°
- **Technologie:** InGaN
- **optischer Wirkungsgrad:** 3 lm/W (blau), 10 lm/W (verde), 13 lm/W (true green)
- **Gruppierungsparameter:** Lichtstärke, Wellenlänge
- **Verarbeitungsmethode:** für alle SMT-Bestücktechniken geeignet
- **Lötmethode:** IR Reflow Löten und Wellenlöten (TTW)
- **Vorbehandlung:** nach JEDEC Level 2
- **Gurtung:** 12 mm Gurt mit 2000/Rolle, ø330 mm
- **ESD-Festigkeit:** ESD-sicher bis 2 kV nach EOS/ESD-5.1-1993

### Anwendungen

- Ampelanwendung (verde)
- Hinterleuchtung (LCD, Schalter, Tasten, Displays, Werbebeleuchtung, Allgemeinbeleuchtung)
- Innenbeleuchtung im Automobilbereich (z.B. Instrumentenbeleuchtung, u. ä.)
- Ersatz von Kleinst-Glühlampen
- Markierungsbeleuchtung (z.B. Stufen, Fluchtwege, u.ä.)
- Signal- und Symbolleuchten

### Features

- **package:** white P-LCC-4 package
- **feature of the device:** focussed radiation in SMT technology; high brightness in beam direction; higher ambient temperature at the same current possible compared to TOPLED®
- **wavelength:** 469 nm (blue), 503 nm (verde), 525 nm (true green)
- **viewing angle:** 20°
- **technology:** InGaN
- **optical efficiency:** 3 lm/W (blue), 10 lm/W (verde), 13 lm/W (true green)
- **grouping parameter:** luminous intensity, wavelength
- **assembly methods:** suitable for all SMT assembly methods
- **soldering methods:** IR reflow soldering and TTW soldering
- **preconditioning:** acc. to JEDEC Level 2
- **taping:** 12 mm tape with 2000/reel, ø330 mm
- **ESD-withstand voltage:** up to 2 kV acc. to EOS/ESD-5.1-1993

### Applications

- traffic lights (verde)
- backlighting (LCD, switches, keys, displays, illuminated advertising, general lighting)
- interior automotive lighting (e.g. dashboard backlighting, etc.)
- substitution of micro incandescent lamps
- marker lights (e.g. steps, exit ways, etc.)
- signal and symbol luminaire

Typ	Emissions- farbe	Farbe der Lichtaustritts- fläche	Partieller Lichtfluss	Lichtstrom	Bestellnummer
Type	Color of Emission	Color of the Light Emitting Area	Partial Flux $I_F = 30 \text{ mA}$ $E_V [\text{lux}]$	Luminous Flux $I_F = 30 \text{ mA}$ $\Phi_V [\text{mlm}]$	Ordering Code
LB E63C-S2U1-35	blue	colorless clear	224 ... 560	230 (typ.)	Q65110A0079
LV E63C-V2AB-35 LV E63C-ABCA-35	verde	colorless clear	900 ...1800 1400 ...3550	785 (typ.) 1450 (typ.)	Q65110A0256 Q65110A0257
LT E63C-V2AB-35 LT E63C-ABCA-35	true green	colorless clear	900 ...1800 1400 ...3550	785 (typ.) 1450 (typ.)	Q65110A0105 Q65110A0106

Anm.: -35 gesamter Farbbereich, Lieferung in Einzelgruppen (siehe Seite 5)

Die Standardlieferform von Serientypen beinhaltet eine untere bzw. eine obere Familiengruppe, die aus nur 3 bzw. 4 Halbgruppen besteht. Einzelne Halbgruppen sind nicht erhältlich.  
In einer Verpackungseinheit / Gurt ist immer nur eine Halbgruppe enthalten.

Da die Gruppierung der LEDs in Lux mit der innovativem Partial Flux methode erfolgt, wurden Vergleichsmessungen an Bauteilen jeweils mit dem "Partial Flux" Testkopf und dem "Standard LED" Testkopf (gemäß CIE-127-B) durchgeführt. Der Vergleich soll als Orientierung dienen, er stellt keine eins zu eins Korrelation dar. Ziel dieses Vergleichs ist ein besseres Verständnis des Lichtflusses in [lux] in Relation zu den Lichtstärkewerten in [cd]. Das Verhältnis von typischen Werten die mit dem "Partial Flux" gemessen werden zu denen, die mit dem standard Messkopf gemessenen ist  $[\text{lux}] \times 0.61 = [\text{cd}]$ .

Note: -35 gesamter Farbbereich, Lieferung in Einzelgruppen (siehe Seite 5)

The standard shipping format for serial types includes a lower or upper family group of 3 or 4 individual groups. Individual half groups are not available.  
No packing unit / tape ever contains more than one luminous intensity half group.

As the grouping of LED in lux is not common in the LED market some measurement to compare the results tested with "Partial Flux" Testhead compared to "standard LED" Testhead (in compliance with CIE-127-B) were made. The comparison should be used for a better understanding of partial flux in [lux] in relation to the values stated in luminous intensity [cd]. It should not be taken as one to one correlation. Comparison of typical values measured with "Partial Flux" and normal LED Testhead are  $[\text{lux}] \times 0.61 = [\text{cd}]$ .

**Grenzwerte**  
**Maximum Ratings**

Bezeichnung Parameter	Symbol Symbol	Wert Value		Einheit Unit
		LB	LV, LT	
Betriebstemperatur Operating temperature range	$T_{op}$	- 40 ... + 100		°C
Lagertemperatur Storage temperature range	$T_{stg}$	- 40 ... + 100		°C
Sperrschichttemperatur Junction temperature	$T_j$	+ 110	+ 125	°C
Durchlassstrom Forward current	$I_F$	30		mA
Stoßstrom Surge current $t \leq 10 \mu s, D = 0.005$	$I_{FM}$	300	400	mA
Sperrspannung <sup>1)</sup> Reverse voltage	$V_R$	5		V
Leistungsaufnahme Power consumption	$P_{tot}$	135		mW
Wärmewiderstand Thermal resistance Sperrschicht/Umgebung Junction/ambient	$R_{th JA}$	350		K/W
Sperrschicht/Löt看pad Junction/solder point Montage auf PC-Board FR 4 (Padgröße $\geq 16 \text{ mm}^2$ ) mounted on PC board FR 4 (pad size $\geq 16 \text{ mm}^2$ )	$R_{th JS}$	180		K/W

<sup>1)</sup> für kurzzeitigen Betrieb geeignet / suitable for short term application

**Kennwerte** ( $T_A = 25\text{ °C}$ )  
**Characteristics**

Bezeichnung Parameter	Symbol Symbol	Werte Values			Einheit Unit
		LB	LV	LT	
Wellenlänge des emittierten Lichtes Wavelength at peak emission $I_F = 30\text{ mA}$	(typ.) $\lambda_{\text{peak}}$	464	501	520	nm
Dominantwellenlänge <sup>1)</sup> Dominant wavelength $I_F = 30\text{ mA}$	(typ.) $\lambda_{\text{dom}}$	469 $\pm 6$	503 $\pm 6$	525 $\pm 9$	nm
Spektrale Bandbreite bei 50 % $I_{\text{rel max}}$ Spectral bandwidth at 50 % $I_{\text{rel max}}$ $I_F = 30\text{ mA}$	(typ.) $\Delta\lambda$	25	30	33	nm
Abstrahlwinkel bei 50 % $I_V$ (Vollwinkel) Viewing angle at 50 % $I_V$	(typ.) $2\phi$	20	20	20	Grad deg.
Durchlassspannung <sup>2)</sup> Forward voltage $I_F = 30\text{ mA}$	(min.) $V_F$ (typ.) $V_F$ (max.) $V_F$	3.3 3.9 4.4	3.3 3.8 4.4	3.3 3.8 4.4	V V V
Sperrstrom Reverse current $V_R = 5\text{ V}$	(typ.) $I_R$ (max.) $I_R$	0.01 10	0.01 10	0.01 10	$\mu\text{A}$ $\mu\text{A}$
Temperaturkoeffizient von $\lambda_{\text{peak}}$ Temperature coefficient of $\lambda_{\text{peak}}$ $I_F = 30\text{ mA}; -10\text{ °C} \leq T \leq 100\text{ °C}$	(typ.) $TC_{\lambda_{\text{peak}}}$	0.05	0.03	0.04	nm/K
Temperaturkoeffizient von $\lambda_{\text{dom}}$ Temperature coefficient of $\lambda_{\text{dom}}$ $I_F = 30\text{ mA}; -10\text{ °C} \leq T \leq 100\text{ °C}$	(typ.) $TC_{\lambda_{\text{dom}}}$	0.04	0.05	0.05	nm/K
Temperaturkoeffizient von $V_F$ Temperature coefficient of $V_F$ $I_F = 30\text{ mA}; -10\text{ °C} \leq T \leq 100\text{ °C}$	(typ.) $TC_V$	- 5.0	- 3.6	- 3.6	mV/K
Optischer Wirkungsgrad Optical efficiency $I_F = 30\text{ mA}$	(typ.) $\eta_{\text{opt}}$	3	10	13	lm/W

<sup>1)</sup> Wellenlängengruppen werden mit einer Stromeinprägedauer von 25 ms und einer Genauigkeit von  $\pm 1\text{ nm}$  ermittelt.  
Wavelength groups are tested at a current pulse duration of 25 ms and a tolerance of  $\pm 1\text{ nm}$ .

<sup>2)</sup> Durchlassspannungswerte werden mit einer Stromeinprägedauer von 1 ms und einer Genauigkeit von  $\pm 0,1\text{ V}$  ermittelt.  
Forward voltage values are tested at a current pulse duration of 1 ms and a tolerance of  $\pm 0.1\text{ V}$ .

<sup>1)</sup> Wellenlängengruppen  
Wavelength groups

Gruppe Group	blue		verde		true green		Einheit Unit
	min.	max.	min.	max.	min.	max.	
3	463	467	497	501	516	522	nm
4	467	471	501	505	522	528	nm
5	471	475	505	509	528	534	nm

Helligkeits-Gruppierungsschema  
Luminous Intensity Groups

Lichtgruppe Luminous Intensity Group	Partieller Lichtfluss Partial Flux $E_V$ [lux]	Lichtstärke Luminous Intensity $I_V$ [mcd]	Lichtstrom Luminous Flux $\Phi_V$ [lm]
S2	224 ... 280	160 (typ.)	150 (typ.)
T1	280 ... 355	200 (typ.)	190 (typ.)
T2	355 ... 450	250 (typ.)	235 (typ.)
U1	450 ... 560	310 (typ.)	300 (typ.)
U2	560 ... 710	390 (typ.)	370 (typ.)
V1	710 ... 900	490 (typ.)	470 (typ.)
V2	900 ... 1120	620 (typ.)	590 (typ.)
AA	1120 ... 1400	770 (typ.)	730 (typ.)
AB	1400 ... 1800	980 (typ.)	930 (typ.)
BA	1800 ... 2240	1240 (typ.)	1120 (typ.)
BB	2240 ... 2800	1540 (typ.)	1415 (typ.)
CA	2800 ... 3550	1940 (typ.)	1840 (typ.)

Helligkeitswerte werden mit einer Stromeinprägedauer von 25 ms und einer Genauigkeit von  $\pm 11\%$  ermittelt.  
Luminous intensity is tested at a current pulse duration of 25 ms and a tolerance of  $\pm 11\%$ .

Gruppenbezeichnung auf Etikett  
Group Name on Label

Beispiel: AB-3

Example: AB-3

Partieller Lichtfluss Partial Flux Group	Halbgruppe Half Group	Wellenlänge Wavelength
A	B	3

Prinzipieller Meßaufbau für partial flux Messung  
Schematic Test Methode for partial flux measurement

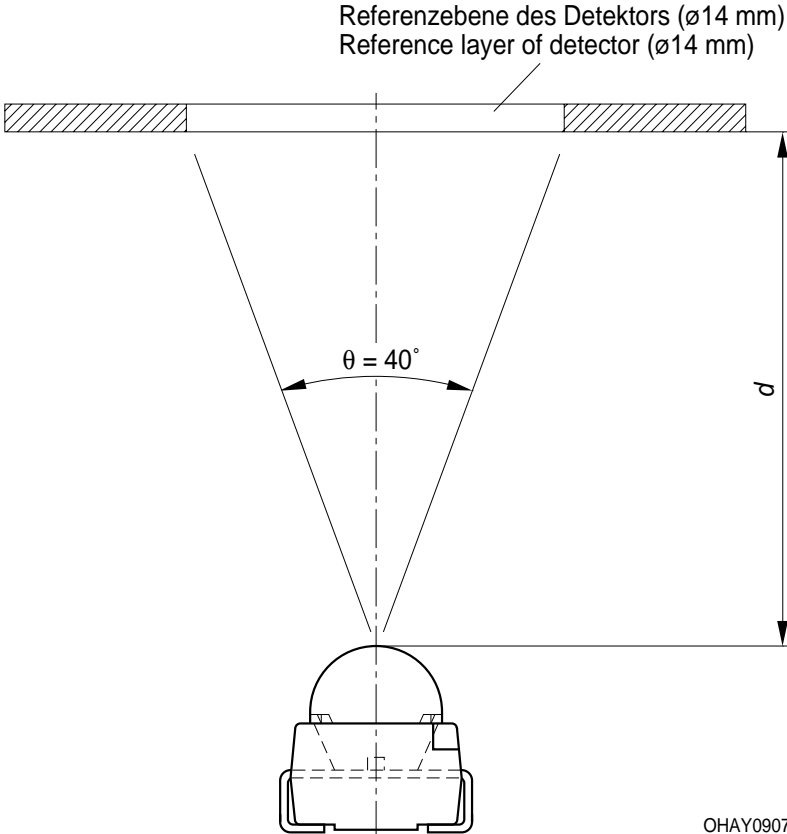

Relative spektrale Emission  $I_{rel} = f(\lambda)$ ,  $T_A = 25\text{ }^\circ\text{C}$ ,  $I_F = 30\text{ mA}$

Relative Spectral Emission

$V(\lambda)$  = spektrale Augenempfindlichkeit  
Standard eye response curve

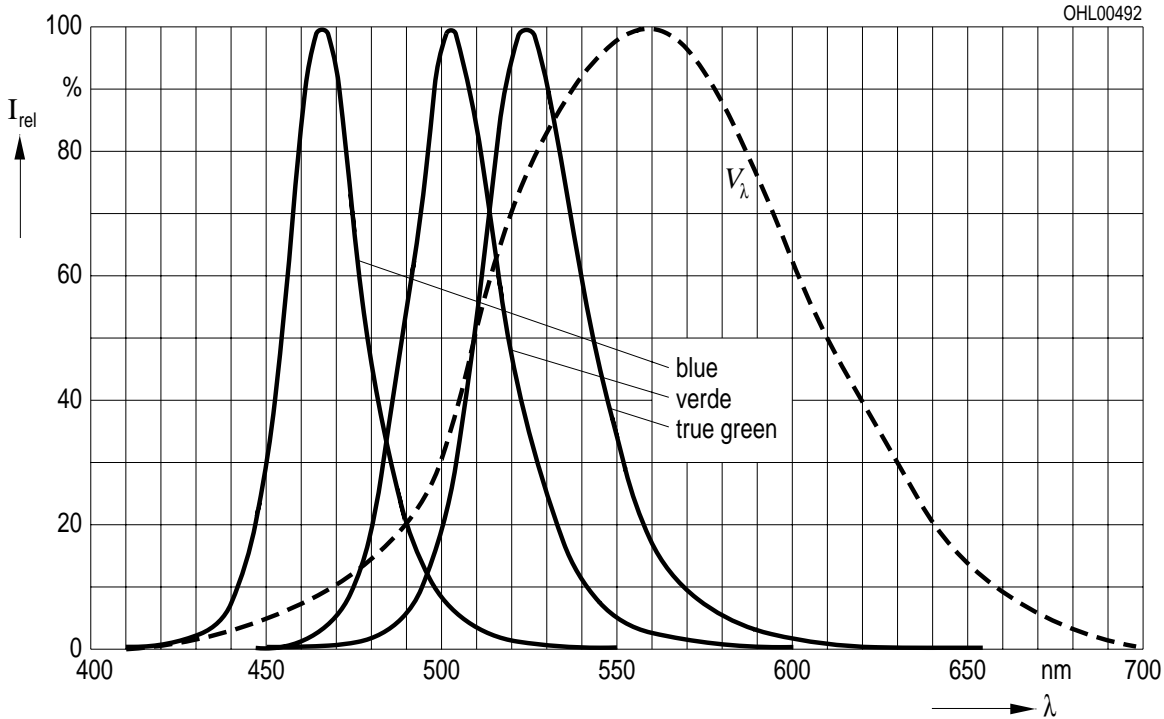

Abstrahlcharakteristik  $I_{rel} = f(\varphi)$

Radiation Characteristic

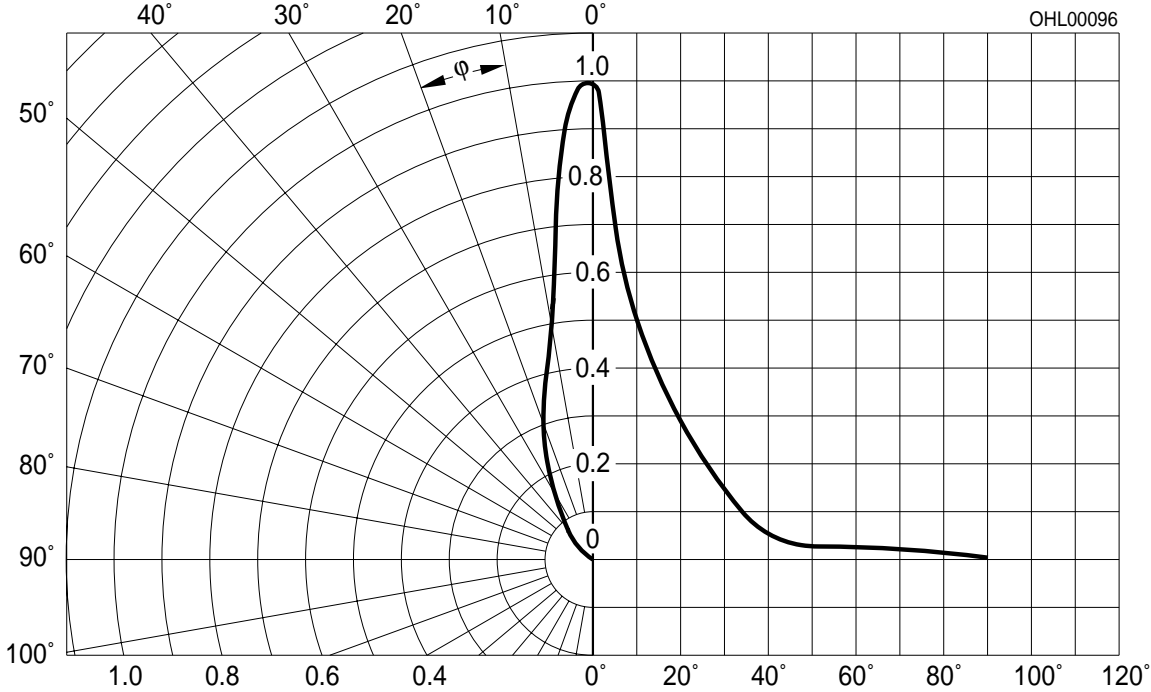

**Durchlassstrom  $I_F = f(V_F)$**   
**Forward Current**

$T_A = 25\text{ }^\circ\text{C}$

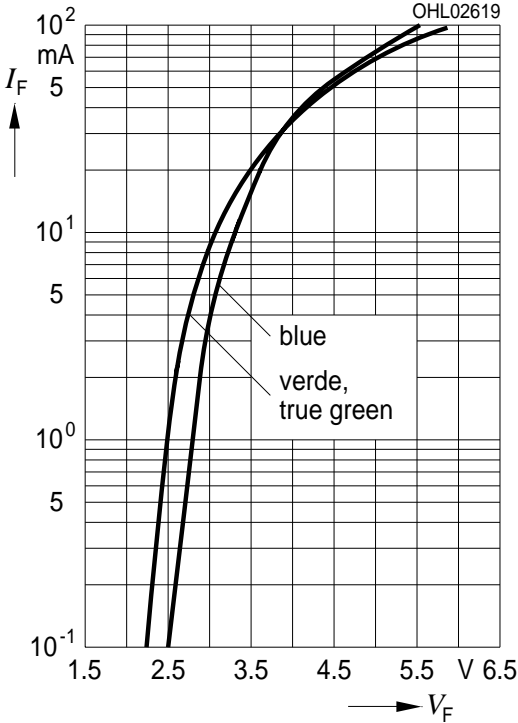

**Relative Lichtstärke  $I_V/I_{V(30\text{ mA})} = f(I_F)$**   
**Relative Luminous Intensity**

$T_A = 25\text{ }^\circ\text{C}$

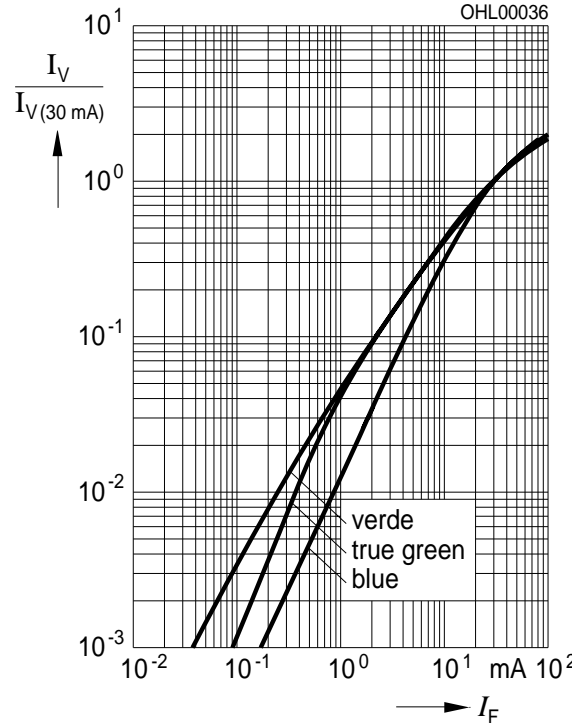

**Maximal zulässiger Durchlassstrom  $I_F = f(T)$**   
**Max. Permissible Forward Current**

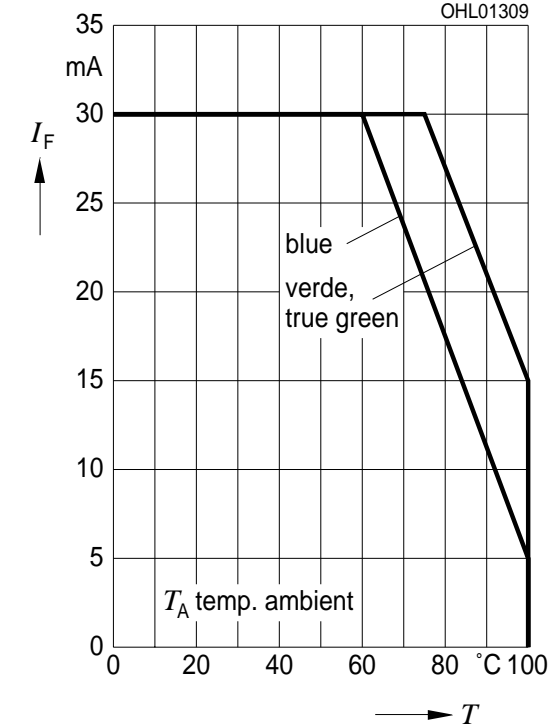

**Maximal zulässiger Durchlassstrom  $I_F = f(T)$**   
**Max. Permissible Forward Current**

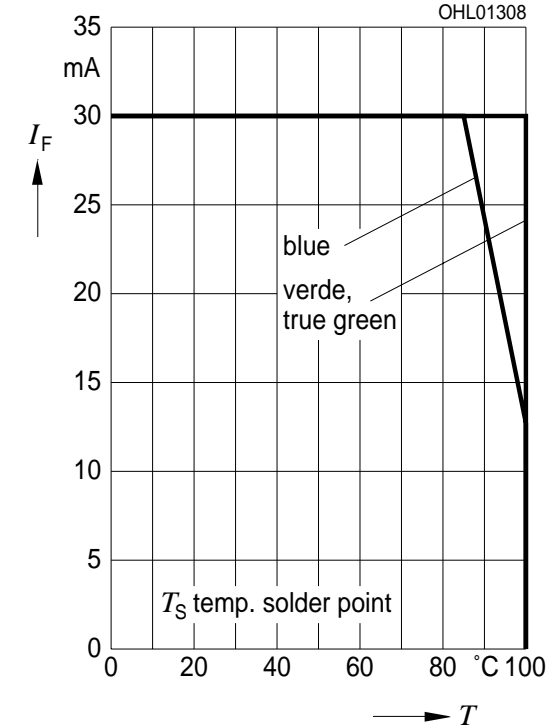



Relative Lichtstärke  $I_V/I_{V(25\text{ °C})} = f(T_A)$   
 Relative Luminous Intensity

$I_F = 30\text{ mA}$

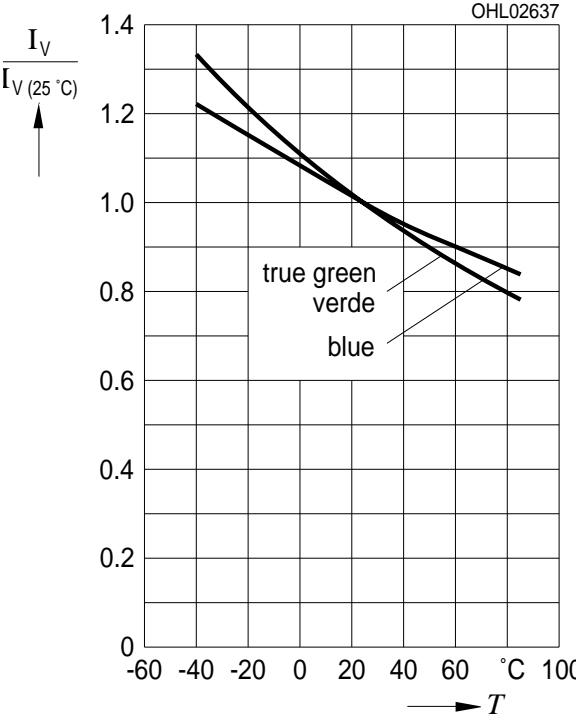

Dominante Wellenlänge  $\lambda_{\text{dom}} = f(I_F)$   
 Dominant Wavelength

LB,  $T_A = 25\text{ °C}$

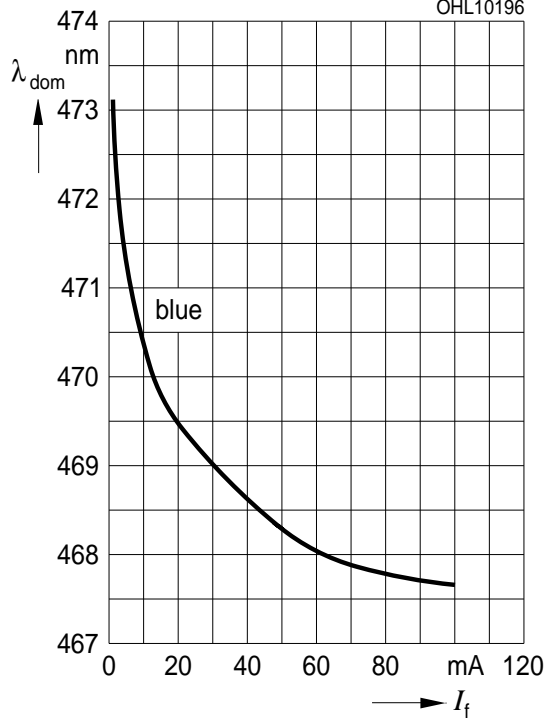

Dominante Wellenlänge  $\lambda_{\text{dom}} = f(I_F)$   
 Dominant Wavelength

LT,  $T_A = 25\text{ °C}$

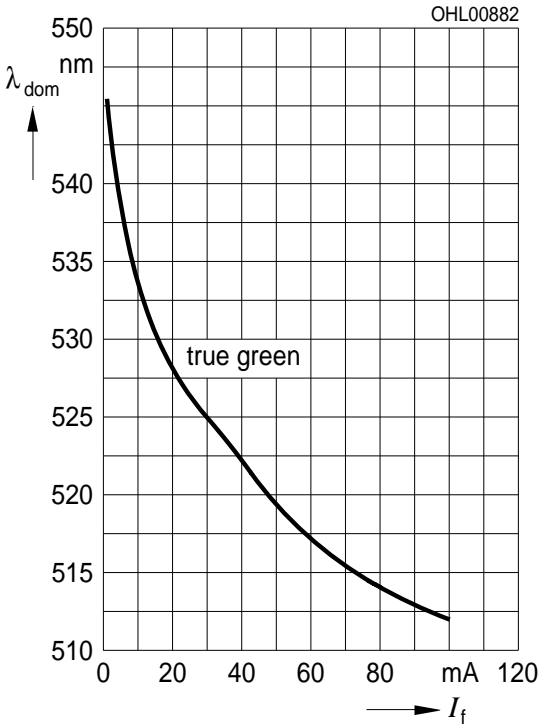

Dominante Wellenlänge  $\lambda_{\text{dom}} = f(I_F)$   
 Dominant Wavelength

LV,  $T_A = 25\text{ °C}$

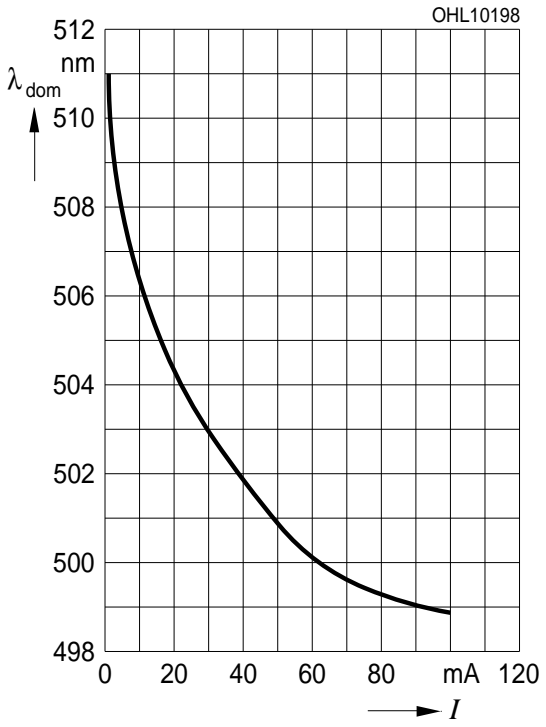

**Zulässige Impulsbelastbarkeit  $I_F = f(t_p)$**   
**Permissible Pulse Handling Capability**  
Duty cycle  $D =$  parameter,  $T_A = 25\text{ °C}$ , LB

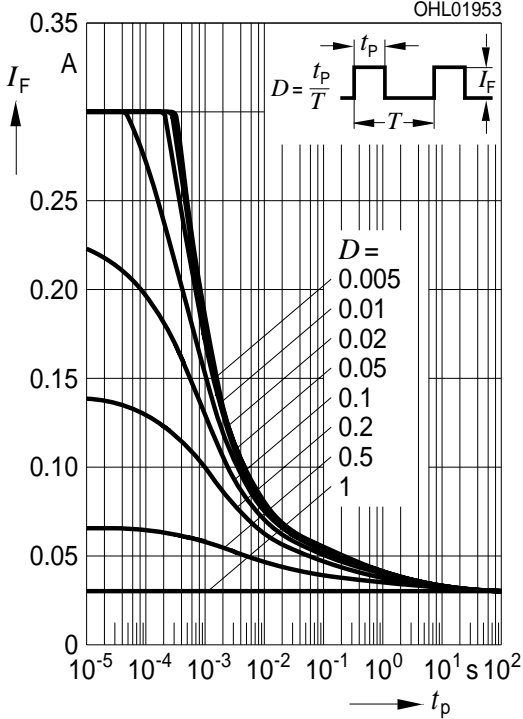

**Zulässige Impulsbelastbarkeit  $I_F = f(t_p)$**   
**Permissible Pulse Handling Capability**  
Duty cycle  $D =$  parameter,  $T_A = 85\text{ °C}$ , LB

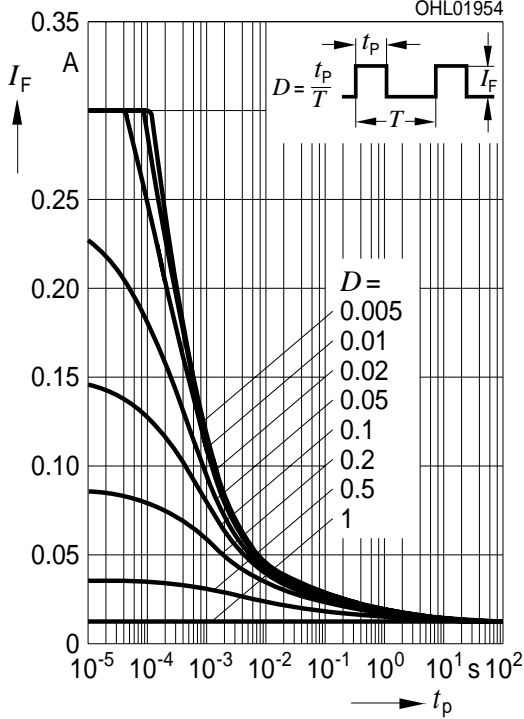

**Zulässige Impulsbelastbarkeit  $I_F = f(t_p)$**   
**Permissible Pulse Handling Capability**  
Duty cycle  $D =$  parameter,  $T_A = 25\text{ °C}$ , LT / LV

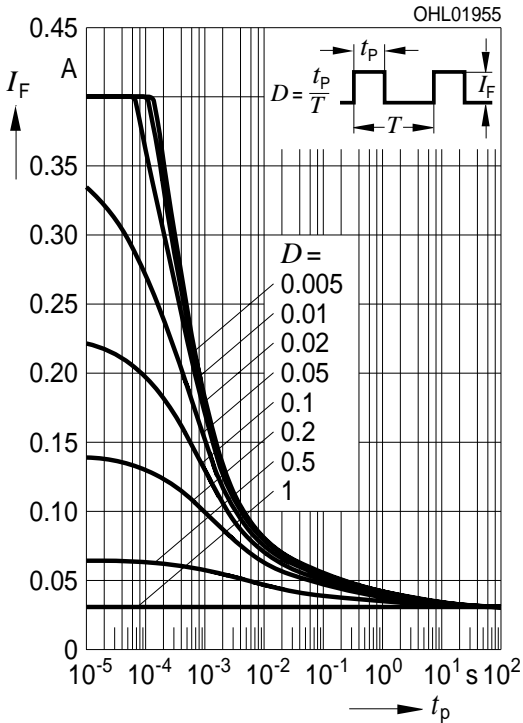

**Zulässige Impulsbelastbarkeit  $I_F = f(t_p)$**   
**Permissible Pulse Handling Capability**  
Duty cycle  $D =$  parameter,  $T_A = 85\text{ °C}$ , LT / LV

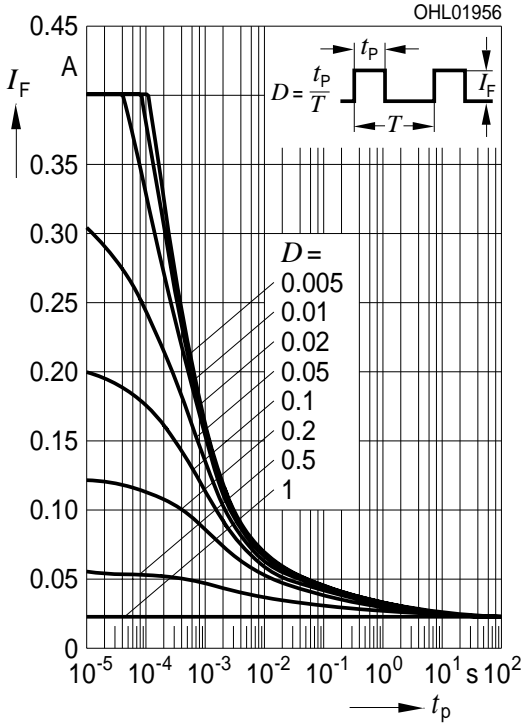



**Lötbedingungen** Vorbehandlung nach JEDEC Level 2  
**Soldering Conditions** Preconditioning acc. to JEDEC Level 2

**IR-Reflow Lötprofil** (nach IPC 9501)  
**IR Reflow Soldering Profile** (acc. to IPC 9501)

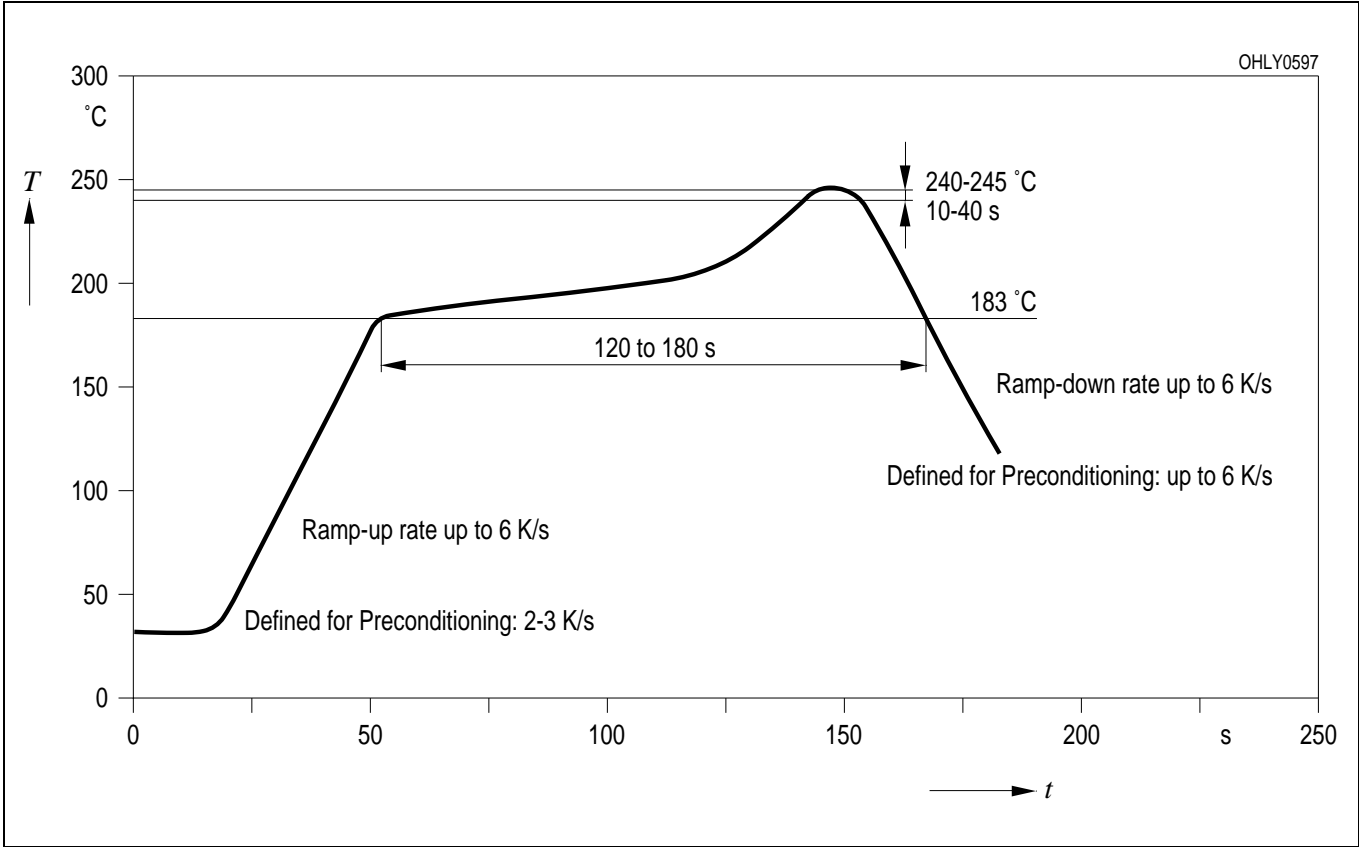

**Wellenlöten (TTW)** (nach CECC 00802)  
**TTW Soldering** (acc. to CECC 00802)

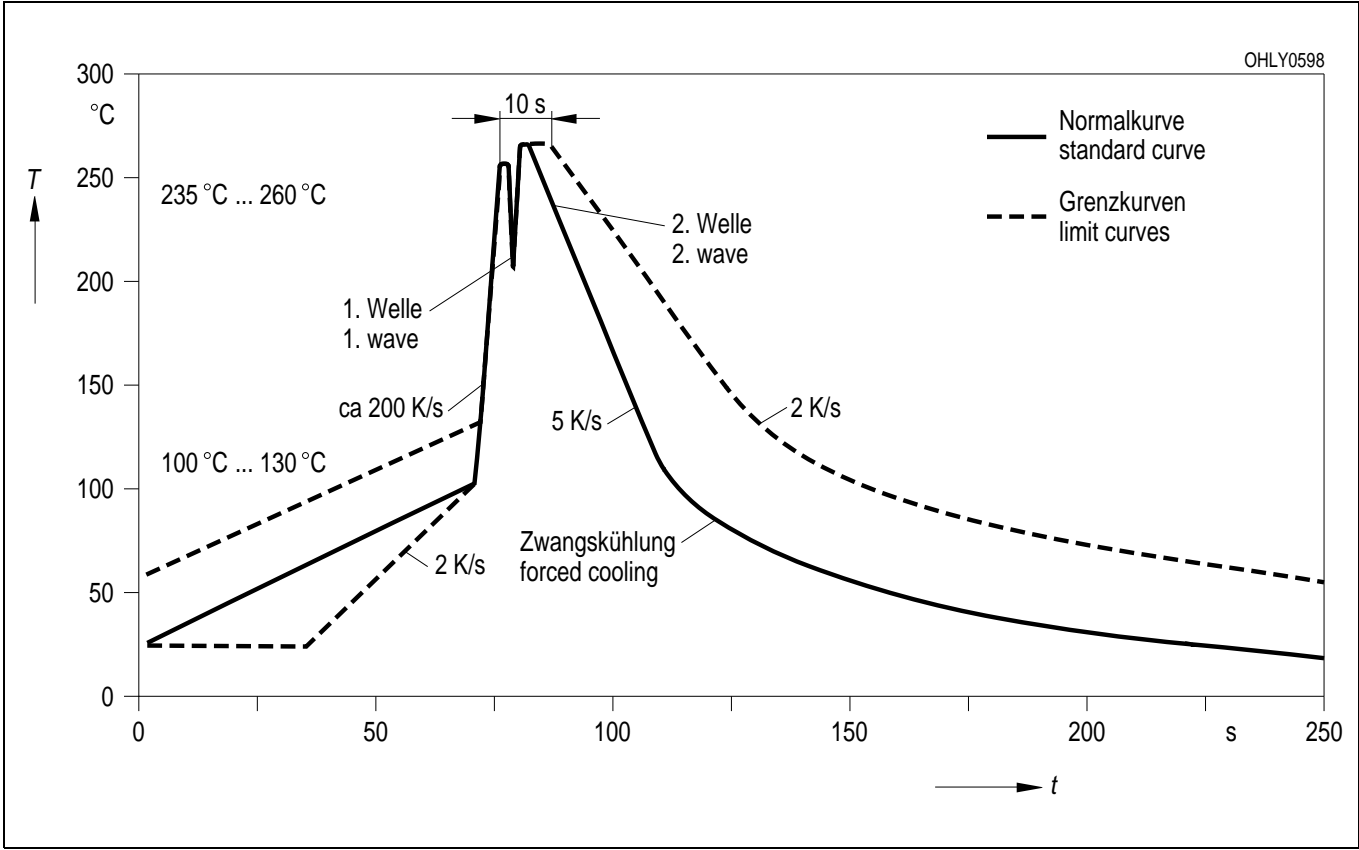

**Empfohlenes Lötpaddesign verwendbar für TOPLED® und Power TOPLED®**

IR Reflow Löten

**Recommended Solder Pad useable for TOPLED® and Power TOPLED®**

IR Reflow Soldering

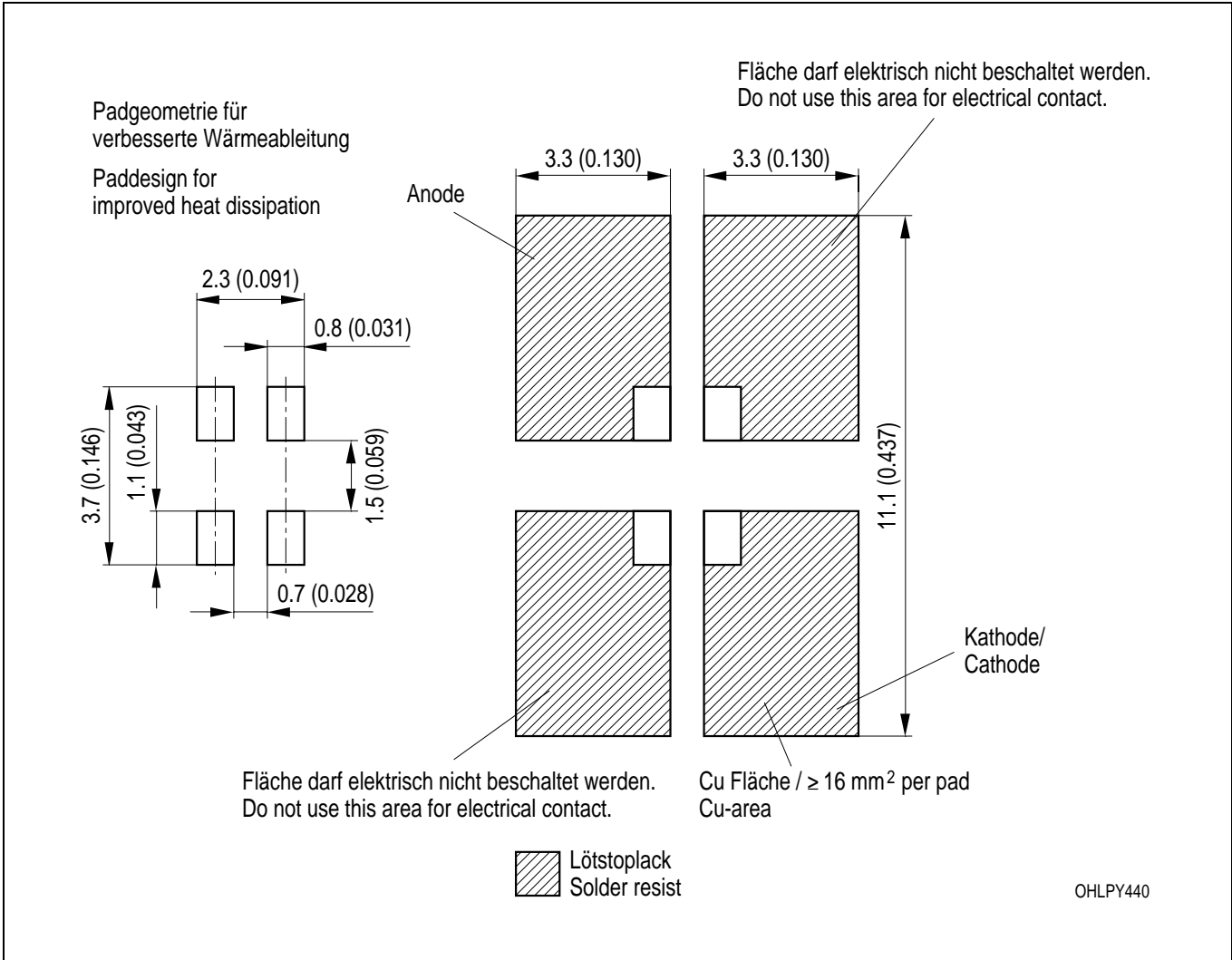

Maße werden wie folgt angegeben: mm (inch) / Dimensions are specified as follows: mm (inch).

**Empfohlenes Lötpad Design** Wellenlöten (TTW)  
**Recommended Solder Pad** TTW Soldering

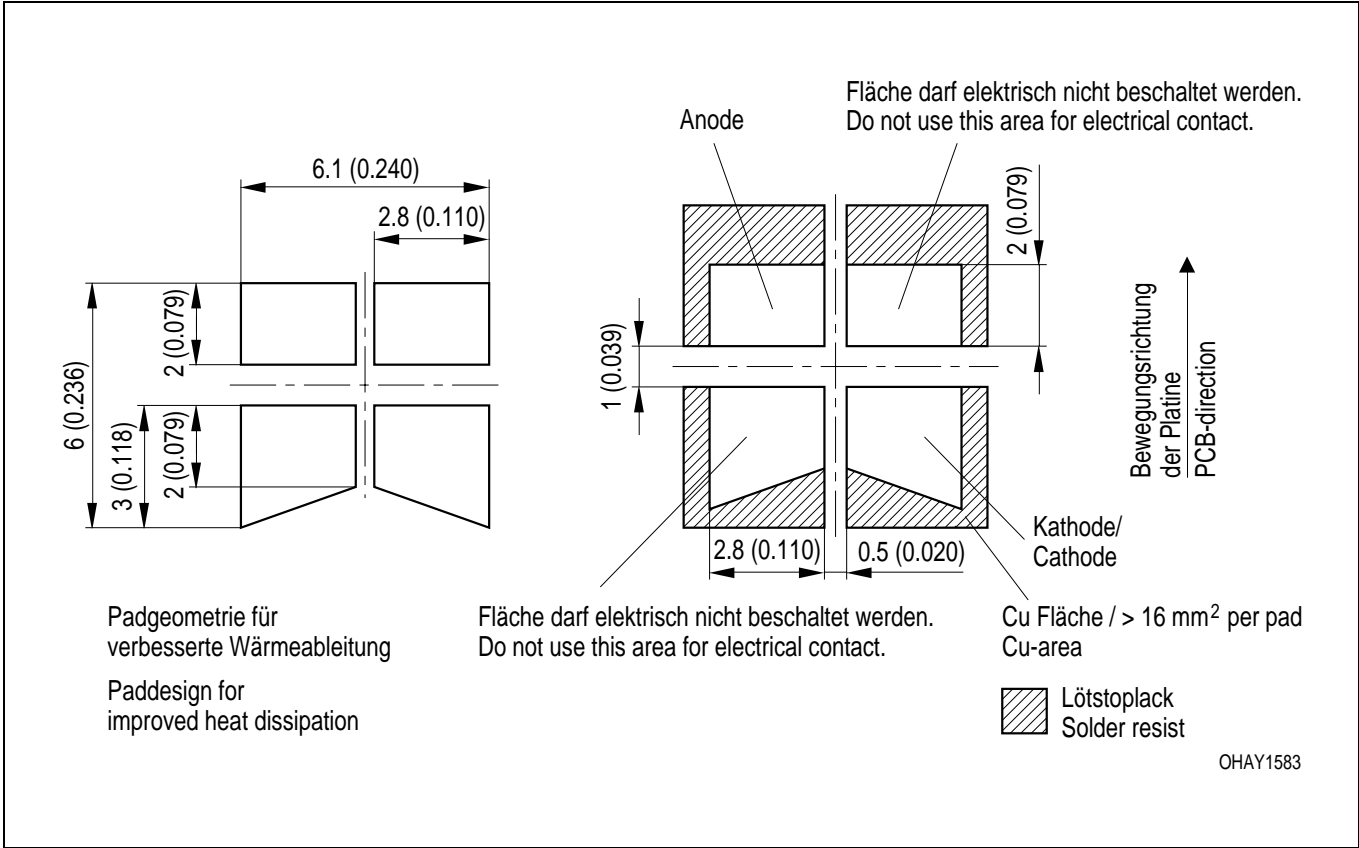

Maße werden wie folgt angegeben: mm (inch) / Dimensions are specified as follows: mm (inch).

**Gurtung / Polarität und Lage** Verpackungseinheit 2000/Rolle, ø330 mm  
**Method of Taping / Polarity and Orientation** Packing unit 2000/reel, ø330 mm

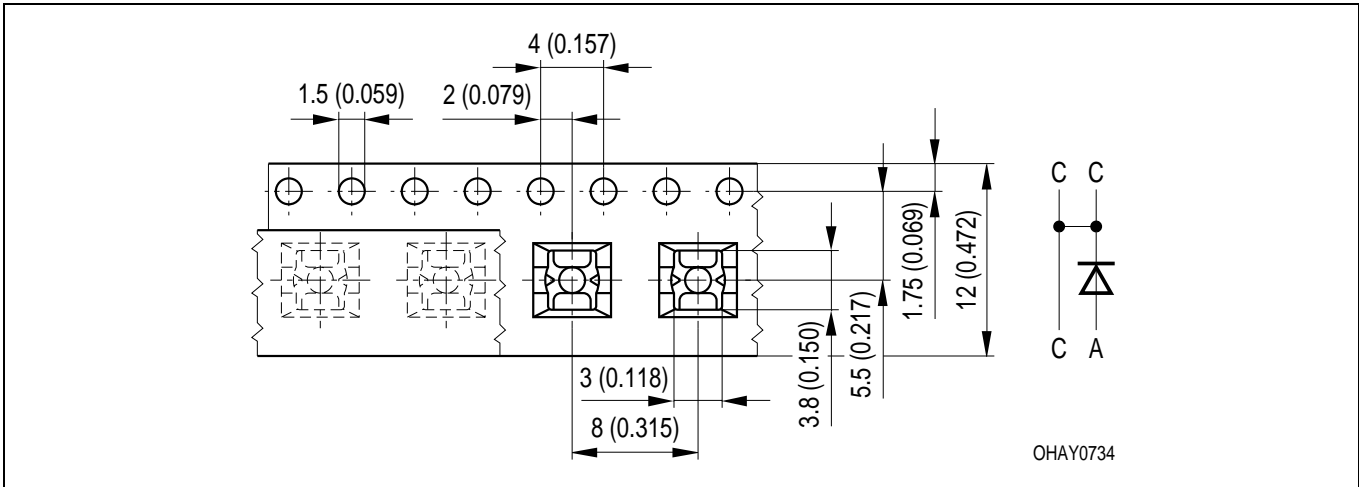

Maße werden wie folgt angegeben: mm (inch) / Dimensions are specified as follows: mm (inch).

Revision History: 2003-08-19		Date of change
Previous Version: 2003-06-02		
Page	Subjects (major changes since last revision)	
6	radiation characteristic	
2	verde (one half-group up)	
2	wavelength grouping for blue, true green and verde	
2; 5	changed to partial flux measurement	
16	annotations	2002-07-23
14	new IR solder pad (OHLPY439 to OHLPY440)	2002-08-05
3	reverse voltage (footnote)	2002-08-21
2, 5	luminous flux values	2002-11-08
6	Schematic Test Methode for partial flux measurement	2002-11-28
13	new recommended solder pad	2003-06-02

**Published by OSRAM Opto Semiconductors GmbH**  
**Wernerwerkstrasse 2, D-93049 Regensburg**  
**© All Rights Reserved.**

**Attention please!**

The information describes the type of component and shall not be considered as assured characteristics. All typical data and graphs are basing on representative samples, but don't represent the production range. If requested, e.g. because of technical improvements, these typ. data will be changed without any further notice. Terms of delivery and rights to change design reserved. Due to technical requirements components may contain dangerous substances. For information on the types in question please contact our Sales Organization. If printed or downloaded, please find the latest version in the Internet.

**Packing**

Please use the recycling operators known to you. We can also help you – get in touch with your nearest sales office. By agreement we will take packing material back, if it is sorted. You must bear the costs of transport. For packing material that is returned to us unsorted or which we are not obliged to accept, we shall have to invoice you for any costs incurred.

**Components used in life-support devices or systems must be expressly authorized for such purpose!** Critical components <sup>1</sup> may only be used in life-support devices or systems <sup>2</sup> with the express written approval of OSRAM OS.

<sup>1</sup> A critical component is a component used in a life-support device or system whose failure can reasonably be expected to cause the failure of that life-support device or system, or to affect its safety or the effectiveness of that device or system.

<sup>2</sup> Life support devices or systems are intended (a) to be implanted in the human body, or (b) to support and/or maintain and sustain human life. If they fail, it is reasonable to assume that the health of the user may be endangered.