

Description

The S52xxM is a u-cap 150mA linear voltage regulator in the SOT-25 package. This regulator has very low dropout voltage and very low ground current. It is designed especially for hand-sets, battery-powered devices and can be controlled by a CMOS or TTL. When the S52xxM is disabled, power consumption drops to nearly zero.

Features

- Low dropout voltage regulator
- Low quiescent current and guaranteed 150mA output
- Zero off-mode current

Ordering Information

Type NO.	Marking	Package Code
S52xxM	5□□	SOT - 25

□□: Voltage Code

Outline Dimensions

unit : mm

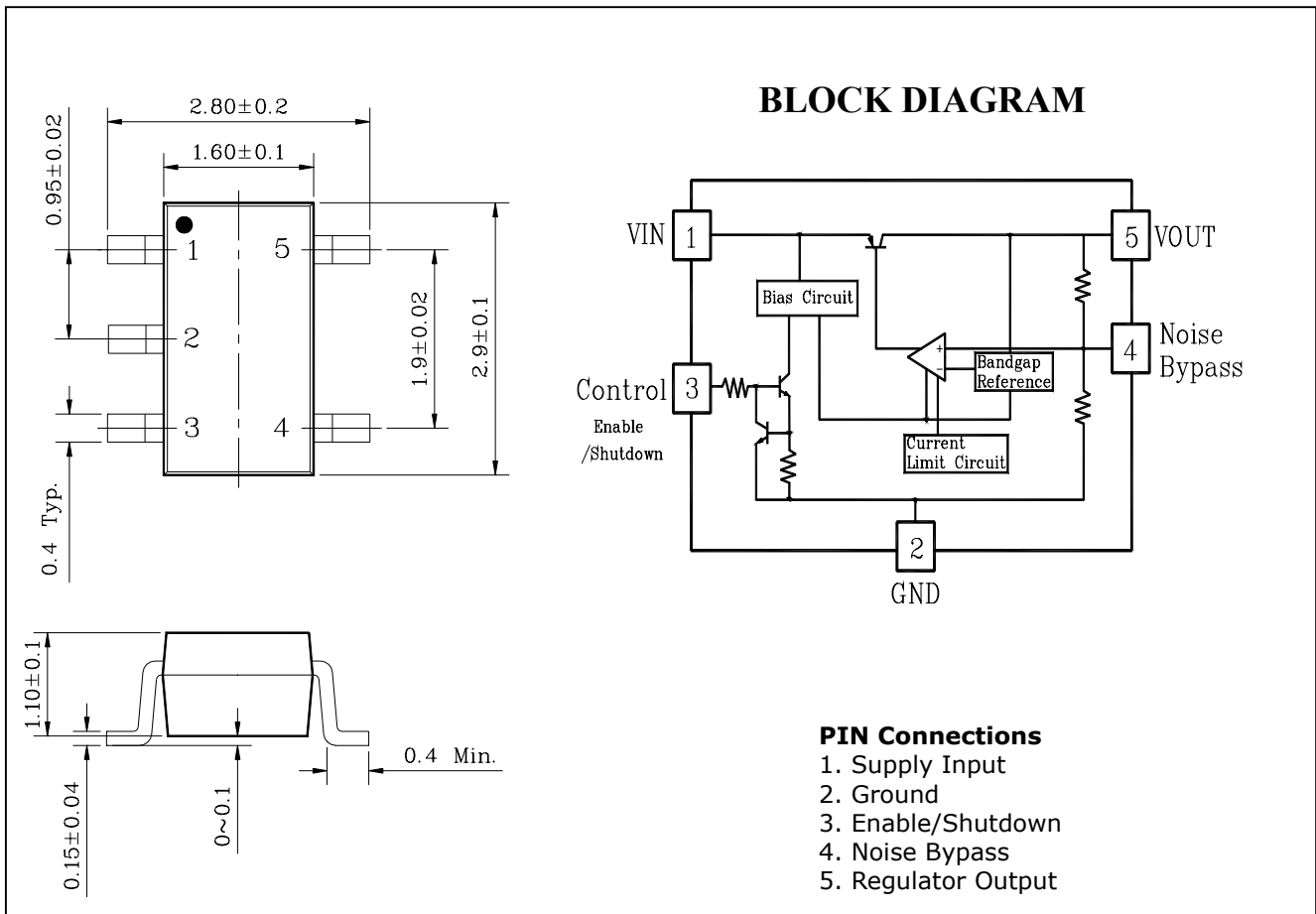

Absolute Maximum Ratings

Ta=25°C

Characteristic	Symbol	Ratings	Unit
Input supply voltage	V _{IN}	-0.4 ~ +16	V
Enable Input Voltage	V _{EN}	-0.4 ~ +16	V
Power Dissipation	P _d	500	mW
Junction Temperature Range	T _j	-40 ~ +125	°C
Storage Temperature Range	T _{stg}	-60 ~ +150	°C
Lead Temperature Time	T _{sol}	260 (5 Sec)	°C

Electrical Characteristics

(※ V_{IN}=V_{OUT}+1V; I_{OUT} = 100uA; C_L=4.7uF; V_{EN}≥2.0V; T_J=25°C)

Characteristic	Symbol	Test Condition	Min.	Typ.	Max	Unit
Output voltage	V _{OUT}	-	See Table 1			
line Regulation	$\frac{\Delta V_{OUT}}{V_{OUT}}$	V _{IN} =V _{OUT} +1V to 16V	-	0.3	5	mV
Load Regulation	$\frac{\Delta V_{OUT}}{V_{OUT}}$	I _{OUT} =1mA ~100mA	-	8	24	mV
Quiescent Current	I _{CC}	V _{EN} ≤0.4V(shutdown)	-	0.01	1	uA
Dropout Voltage	V _{DROP}	* I _{OUT} =50mA (V _{OUT} =1.5V)	-	400	500	mV
		* I _{OUT} =100mA (V _{OUT} =1.5V)	-	500	600	
		* I _{OUT} =50mA (V _{OUT} =1.8V)	-	150	250	
		* I _{OUT} =100mA (V _{OUT} =1.8V)	-	250	450	
		* I _{OUT} =100uA	-	10	50	
		* I _{OUT} =50mA	-	110	150	
Ground Pin Current	I _{GND}	I _{OUT} =50mA, V _{EN} ≥2.0(active) (V _{out} =1.5V/1.8V)	-	1.5	3.0	mA
		I _{OUT} =50mA, V _{EN} ≥2.0(active)	-	0.8	1.5	
Output Noise	e _{no}	I _{OUT} =50mA, C _L =4.7uF 470pF from BYP to GND	-	260	-	nV/√Hz
Enable Input Logic-Low Voltage	V _{IL}	Regulator Shutdown	-	-	0.4	V
Enable Input Logic-High Voltage	V _{IH}	Regulator enabled	1.6	-	-	V
Enable Input Current	I _{IL}	V _{IL} ≤0.4V	-	0.01	1	uA
	I _{IH}	V _{IH} ≥2.0V	2	5	10	

*Note1 : Dropout Voltage is the difference between the input voltage and the output voltage at which point the regulator starts to fall out of regulation (this is the point when the output voltage decreases by 100mV).

Table 1

Electrical Characteristics Table

Test Condition; $V_{IN} = V_{OUT(TYP)} + 1V$, $I_{OUT} = 100\mu A$, $T_A = 25^\circ C$, unless otherwise specified.

Output Voltage [V]	Voltage Code	Voltage Limit [V]	
		MIN	MAX
1.5	15	1.440	1.560
1.8	18	1.728	1.872
2.5	25	2.400	2.600
2.8	28	2.688	2.912
3.0	30	2.880	3.120
3.3	33	3.168	3.432
5.0	50	4.800	5.200

■ Typical Applications

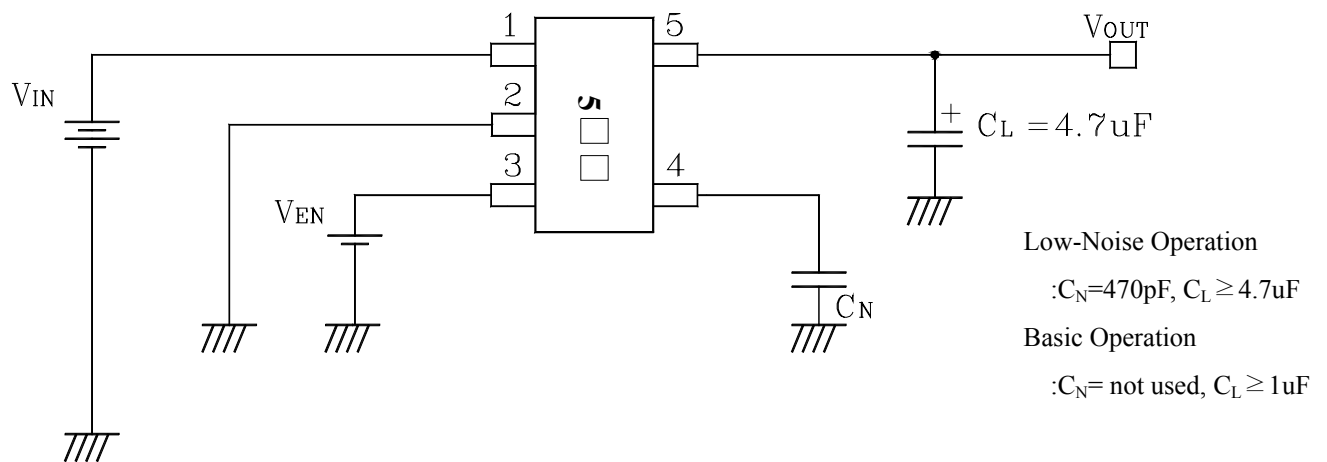

Electrical Characteristic Curves

Fig. 1. Drop Voltage vs Output Current

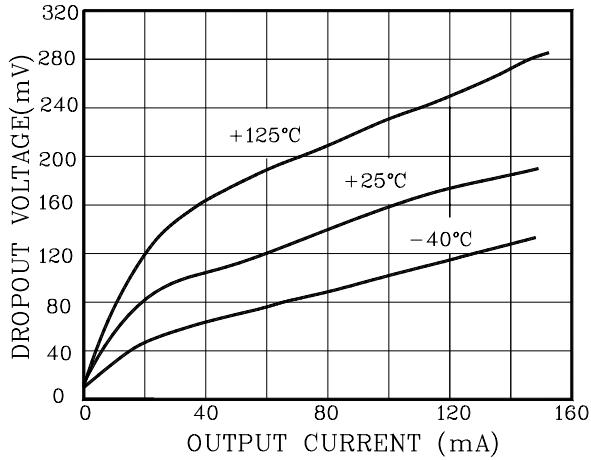

Fig. 2 Power Supply Rejection Ratio

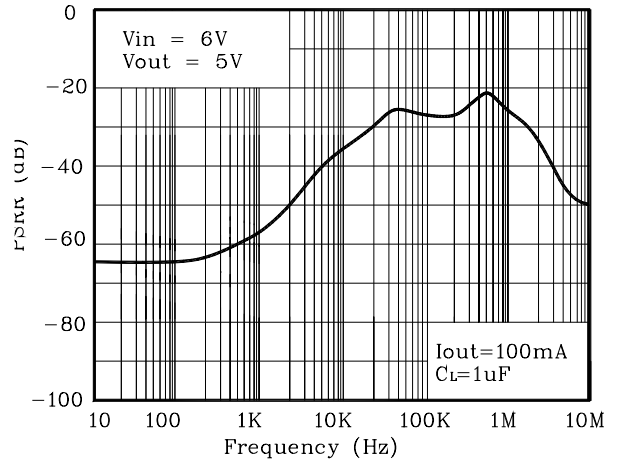

Fig. 3. Turn-On Time vs Bypass Capacitance

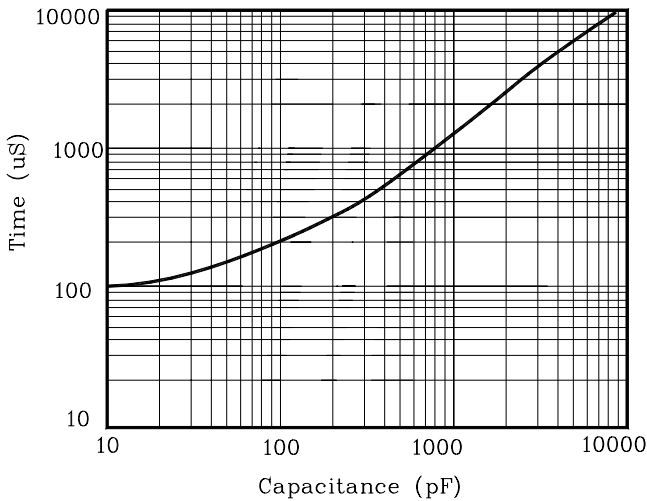

Fig. 4 Power Supply Ripple Rejection vs Voltage Drop

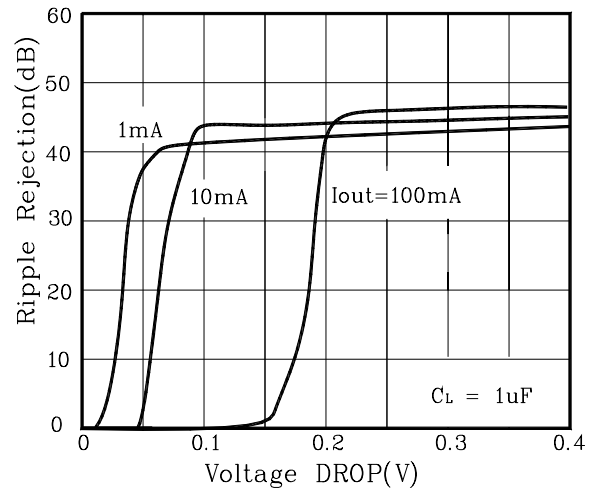

Fig.5 Noise vs I_{out}

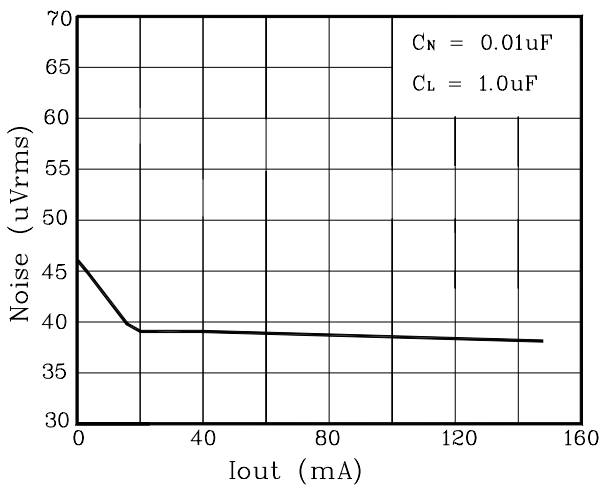
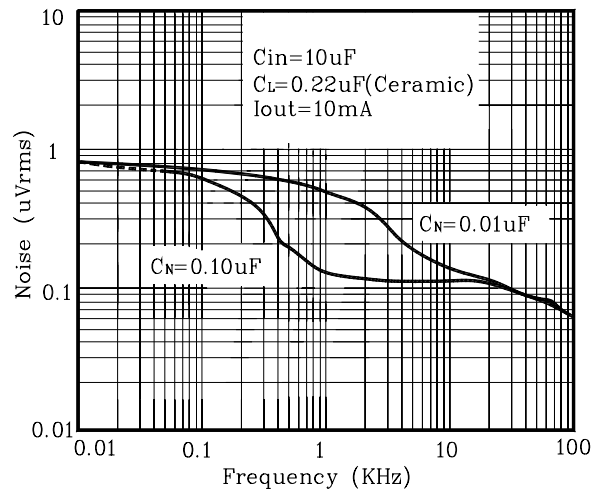

Fig.6. Noise vs Frequency



Electrical Characteristic Curves (Cont.)

Fig. 7. Output Voltage Response

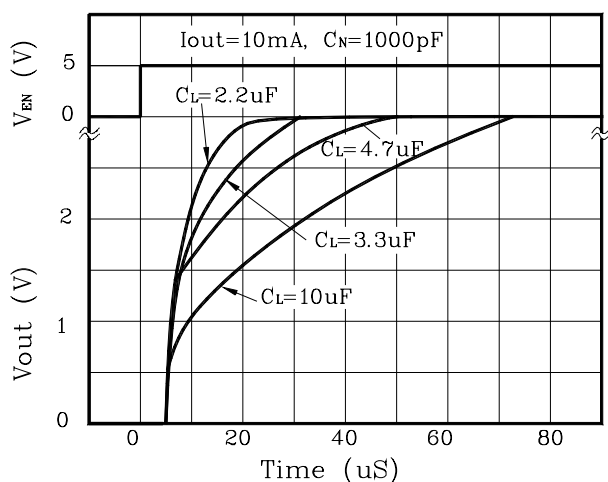
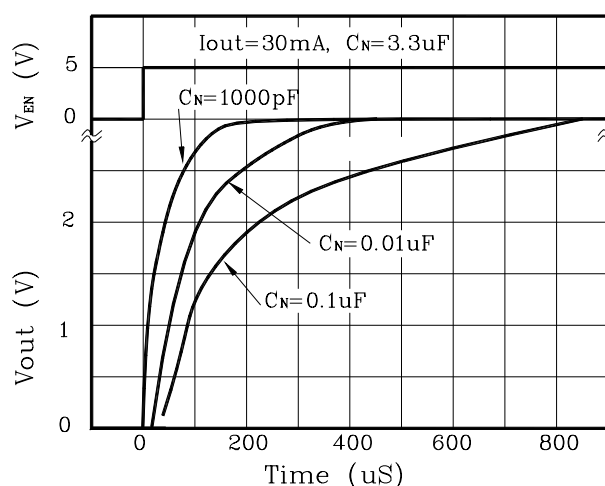

Fig. 8 Output Voltage Response



Shutdown (Dis/Enable) Operation

The S52xxM output can be turned off by applying 0.4V or less to the device's Dis/Enable pin (pin3). In shutdown mode, the S52xxM draws less than 1uA quiescent current. The output of the S52xxM is enabled by applying 1.5V to 13V at the Dis/Enable pin. In applications where the S52xxM output will always remain enabled, the Dis/Enable pin may be connected to Vin(pin1). The S52xxM's shutdown circuitry includes hysteresis, as such the device will operate properly even if a slow moving signal is applied to the Dis/Enable pin. The device's shutdown pin includes a 2M Ω internal pull down resistor connected to ground.

Short Circuit Protection

The S52xxM output can withstand momentary short circuit to ground. Moreover, the regulator can deliver very high output peak current due to its 1A instantaneous short circuit current capability.

Noise Bypass Capacitor

In low noise applications, the self noise of the S52xxM can be decreased further by connecting a capacitor from the noise bypass pin (pin4) to ground (pin2). The noise bypass pin is a high impedance node as such care should be taken in printed circuit board layout to avoid noise pick-up from external sources. Moreover, the noise bypass capacitor should have low leakage. Noise bypass capacitors with a value as low as 470pF may be used. However, for optimum performance, use a 0.01uF or larger, ceramic chip capacitor. Note that the turn on and turn off response of the S52xxM is inversely proportional to the value of the noise bypass capacitor. For fast turn on and turn off, use a small value noise Bypass capacitor. In applications where exceptionally low output noise is not required, consider omitting the noise Bypass capacitor altogether.

Output Capacitor Selection

AUK strongly recommends the use of low ESR(Equivalent series resistance) ceramic capacitors for C_{out} and C_N . The S52xxM is stable with low ESR capacitor (as low as zero Ω). The value of the output capacitor should be 1 μ F or higher. Either ceramic chip or a tantalum capacitor may be used at the output. Use of ceramic chip capacitors offer significant advantages over tantalum capacitors. A Ceramic capacitor is typically cheaper than a tantalum capacitor, it usually has a smaller footprint, lower height, and lighter weight than a tantalum capacitor. Furthermore, unlike tantalum capacitors which are polarized and can be damaged if connected incorrectly, ceramic capacitors are non-polarized. Low value ceramic chip capacitors with X5R or X7R dielectric are available in the 100pF to 4.7 μ F range. Beware of using ceramic capacitors with Y5V dielectric since their ESR increases significantly at cold temperatures. Figure 9 shows a list of recommended ceramic capacitors for use at the output of S52xxM.

If a tantalum output capacitor is used then for stable operation AUK recommends a low ESR tantalum capacitor with maximum rated ESR at or below 0.4 Ω . Low ESR tantalum capacitors, such as the TPS series from AVX Corporation (www.avxcorp.com) or the T495 series from Kemet (www.kemet.com) may be used.

In applications where a high output surge current can be expected, use a high value but low ESR output capacitor for superior load transient response. The S52xxM is stable with no load.

Fig. 9

C_{OUT}	Capacitor Size	I_{OUT}	Dielectric	Part Number	Capacitor Vendor
1 μ F	0805	0 to 150mA	X5R	C2012X5R1A105KT	TDK
"	0805	"	X7R	GRM40X7R105K010	muRata
"	0805	"	X7R	LMK212BJ105KG	Taiyo-Yuden
"	1206	"	X7R	GRM42-6X7R105K016	muRata
"	1206	"	X7R	EMK316BJ105KL	Taiyo-Yuden
"	1206	"	X5R	TMK316BJ105KL	Taiyo-Yuden
2.2 μ F	0805	0 to 150mA	X5R	GRM40X5R225K 6.3	muRata
"	0805	"	X5R	C2012X5R0J225KT	TDK
"	1206	"	X5R	EMK316BJ225ML	Taiyo-Yuden
4.7 μ F	1206	0 to 150mA	X5R	GRM42-6X5R475K010	MuRata
"	1206	"	X7R	LMK316BJ475ML	Taiyo-Yuden