

ACT4419

Single Supply Variable Amplitude Transceivers

for MIL-STD-1553

Preliminary

Features

- First fully monolithic 5V only Variable Amplitude Transceiver
- Lowest standby power
- Transceiver meets military data bus requirements, MIL-STD-1553 and MIL-STD-1760
- Low power dissipation at full output power
- Single +5V power supply
- Current source output
- Monolithic construction using dielectrically isolated(D.I.)
- Processed and screened to MIL-STD-883 specs
- Radiation Hard to 2.5 MRADS Total Dose
- DESC SMD pending
- Either 5V or 10V DC control line (Factory Set)

AEROFLEX
CIRCUIT TECHNOLOGY
www.aeroflex.com

General Description

The Aeroflex Circuit Technology model ACT4419 is a next generation D.I. monolithic transceiver which provides variable amplitude in full compliance with MIL-STD-1553/1760 data bus requirements with the lowest standby power consumption available and one power supply operation.

The model ACT4419 performs the front-end analog function of inputting and outputting data through a transformer to a MIL-STD-1553/1760 data bus.

Design of these transceivers reflects particular attention to active filter performance. This results in low bit and word error rate with superior waveform purity and minimal zero crossover distortion. Efficient transmitter electrical and thermal design provides low internal power dissipation and heat rise at high as well as low duty cycles.

Variable amplitude is adjusted with factory preset 0 - 10 Vdc or 0 - 5 Vdc control line at 1mA maximum input current.

Transmitter

The Transmitter section accepts bi-phase TTL data at the input and when coupled to the data bus with a **primary grounded center tap 1:2.5 transformer**, isolated on the data bus side with two 52.5 Ohm fault isolation resistors, and loaded by two 70 Ohm terminations plus additional receivers, the data bus signal produced is 7.5Volts nominal P-P at A-A' (See Figure 5). When both DATA and $\overline{\text{DATA}}$ inputs are held low or high, the transmitter output becomes a high impedance and is "removed" from the line. In addition, an

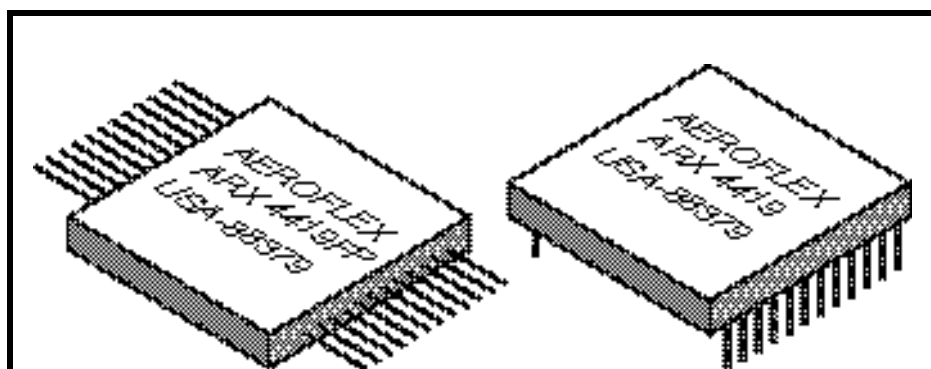

ACT4419FP & ACT4419 Plug In Transceivers

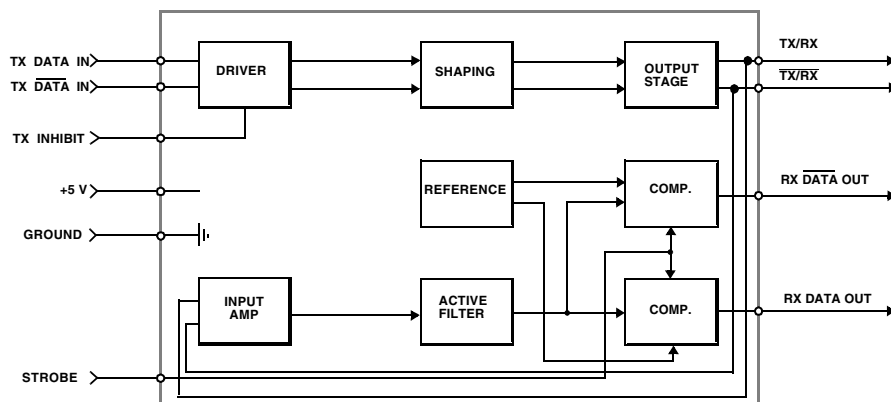

Block Diagram

overriding "INHIBIT" input provides for the removal of the transmitter output from the line. A logic "1" applied to the "INHIBIT" takes priority over the condition of the data inputs and disables the transmitter. (See Transmitter Logic Waveform, Figure 1).

The transceiver utilizes an active filter to suppress harmonics above 1MHz. The Transmitter may be safely operated at 100% duty cycle for an indefinite period into a short circuited 1553 bus.

Receiver

The Receiver section accepts bi-phase differential data at the input and produces two TTL signals at the output. The outputs are DATA and $\overline{\text{DATA}}$, and represent positive and negative excursions of the input beyond a pre-determined threshold. (See Receiver Logic Waveform, Figure 2).

The pre-set internal thresholds will detect data bus signals exceeding 1.150 Volts P-P and reject signals less than 0.6 volts P-P when used with a 1:2.5 turns ratio transformer. (See Figure 5 for transformer data and typical connection).



Figure 1 - Transmitter Logic Waveforms

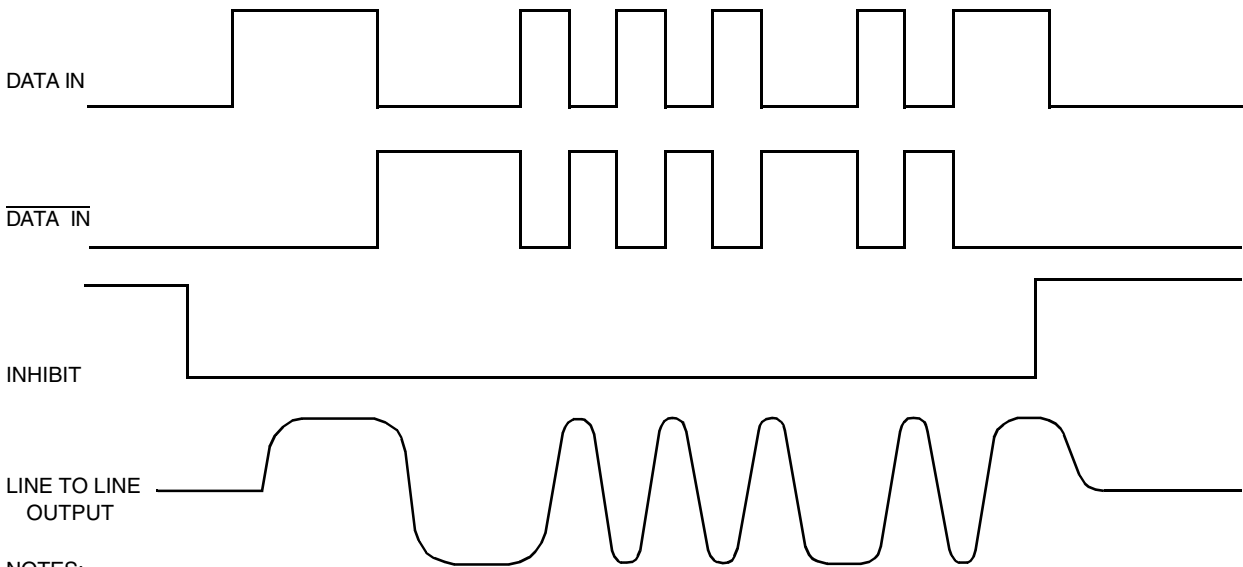

NOTES:

1. DATA and $\overline{\text{DATA}}$ inputs must be complementary waveforms or 50% duty cycle average, with no delays between them.
2. DATA and $\overline{\text{DATA}}$ must be in the same state during off time (both high or low).

Figure 2 - Receiver Logic Waveforms

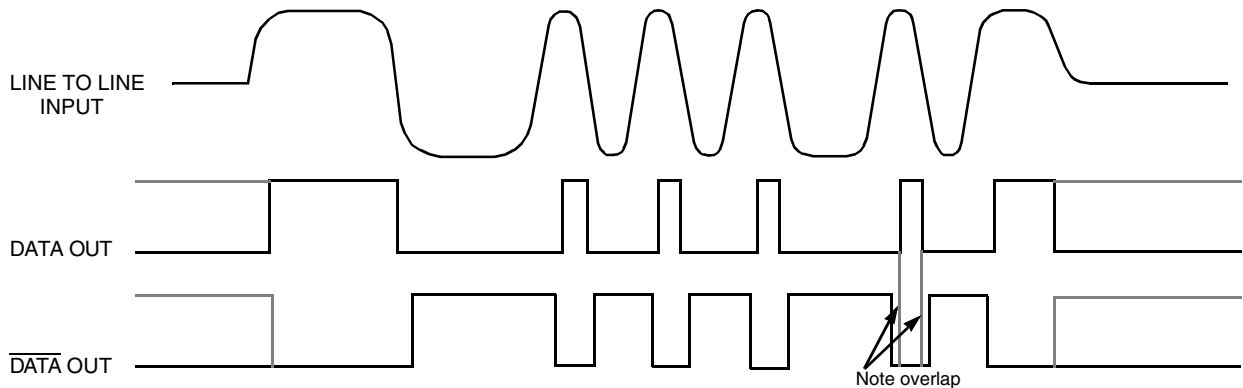

NOTE: Waveforms shown are for normally low devices. For normally high receiver output level devices, the receiver outputs are swapped as shown by the dashed lines.

Absolute Maximum Ratings

Operating Case Temperature	-55°C to +125°C
Storage Case Temperature	-65°C to +150°C
Positive Power Supply Voltage	+5.0 V to +7.0 V
Receiver Differential Input	±10 V
Receiver Input Voltage (Common Mode)	±5 V
Driver Peak Output Current	650 mA
Total Package Power Dissipation over the Full Operating Case Temperature Rise	2 Watt
Maximum Junction To Case Temperature Rise for the Hottest Device	10°C
Thermal Resistance, Junction to Bottom of Case	5°C/W

Electrical Characteristics – Driver Section

Input Characteristics, TX DATA in or TX $\overline{\text{DATA}}$ in

Parameter	Condition	Symbol	Min	Typ	Max	Unit
"0" Input Current	$V_{IN} = 0.4 \text{ V}$	I_{ILD}		-0.2	-0.4	mA
"1" Input Current	$V_{IN} = 2.7 \text{ V}$	I_{IHD}		1	40	μA
"0" Input Voltage		V_{IHD}			0.7	V
"1" Input Voltage		V_{IHD}	2.0			V

Inhibit Characteristics

"0" Input Current	$V_{IN}=0.4\text{V}$	I_{ILI}		-0.2	-0.4	mA
"1" Input Current	$V_{IN}=2.7\text{V}$	I_{IHI}		1.0	40	μA
"0" Input Voltage		V_{ILI}			0.7	V
"1" Input Voltage		V_{IHI}	2			V
Delay from TX inhibit,(0→1) to inhibited output		t_{DXOFF}		200	300	nS
Delay from TX inhibit, (1→0) to active output		t_{DXON}		80	150	nS
Differential Output Noise, inhibit mode		V_{NOI}		2	10	mVp-p
Differential Output Impedance (inhibited)	Note 1	Z_{OI}	2K			Ω

Output Characteristics

Differential output level	Pt. A - A'	V_O	6	7.5	8	V p-p
Rise And Fall Times(10% to 90% of p-p output)		t_r	100	170	300	nS
Output Offset at point A-A'on Fig 5., 2.5 μS after midpoint crossing of the parity bit of the last word of a 660 μS message	$R_L=35 \Omega$	V_{OS}			±90	mV peak
Delay from 50% point of TX DATA or TX $\overline{\text{DATA}}$ input to zero crossing of differential signal		t_{DTX}		100	150	nS
Control Voltage Slope 0 – 5 Vdc measured at Pt A - A' 0 – 10 Vdc measured at Pt A - A'	$I_L = 1 \text{ mA max}$		1.1 0.55	1.5 0.75	1.9 0.95	Vp-p/Vdc Vp-p/Vdc

Electrical Characteristics – Receiver Section

Parameter	Condition	Symbol	Min	Typ	Max	Unit
Differential Voltage Range, Figure 4 Point P-P'		V_{IDR}			20	V peak
Common Mode Rejection Ratio		CMRR	45			dB

Strobe Characteristics (Logic "0" inhibits output) if not used, a 1K pullup to 5 V is recommended

"0" Input Current	$V_S=0.4\text{ V}$	I_{IL}		-0.2	-0.4	mA
"1" Input Current	$V_S=2.7\text{V}$	I_{IH}		1	+40	μA
"0" Input Voltage		V_{IL}			0.7	V
"1" Input Voltage		V_{IH}	2.0			V
Strobe Delay (turn-on)		$t_{SD(ON)}$		40	100	nS
Strobe Delay (turn-off)		$t_{SD(OFF)}$		60	100	nS

Threshold Characteristics (Sinewave input)

Input Threshold Voltage(referred to the bus)	100KHz-1MHz	V_{TH}	0.60	0.8	1.15	Vp-p
--	-------------	----------	------	-----	------	------

Output Characteristics, RX DATA and RX DATA

"1" State	$I_{OH}=-0.4\text{ mA}$	V_{OH}	2.5	3.7		V
"0" State	$I_{OL} = 4\text{ mA}$	V_{OL}		0.3	0.5	V
Delay, (average)from differential input zero crossings to RX DATA and RX DATA output 50% points		t_{DRX}		250	400	nS

Power Data

Maximum Currents, Per Channel (+5V)

Duty Cycle	Typ	Max
Transmitter Standby	20 mA	30 mA
25% duty cycle	155 mA	185 mA
50% duty cycle	290 mA	335 mA
100% duty cycle	560 mA	650 mA

Power Supply Voltage

+V	4.75 to 5.5 Volts
----	-------------------

Notes: 1. Power ON/OFF, measured from 75KHz to 1MHz at Point A-A. See Figure 5

2. $V_{CC} = 5\text{ volts} \pm 0.1\text{ V}$, for all measurements unless otherwise specified.

3. Specifications apply over the case temperature range of -55°C to $+125^{\circ}\text{C}$ unless otherwise specified.

4. All typical values are measured at $+25^{\circ}\text{C}$

Figure 3 – Transmitter (TX) Output Amplitude vs Control Voltage

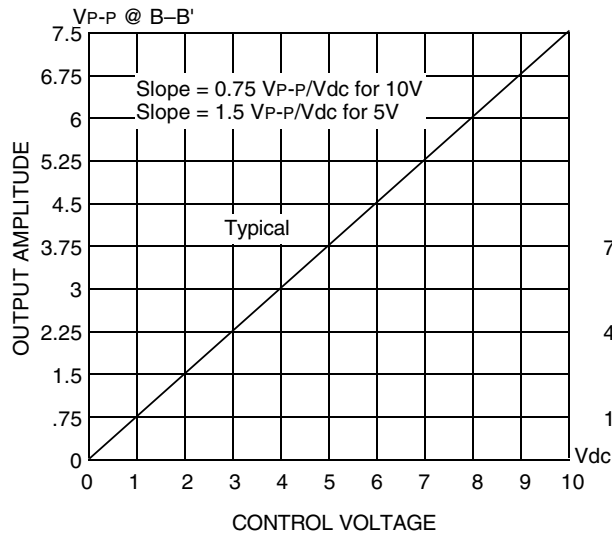
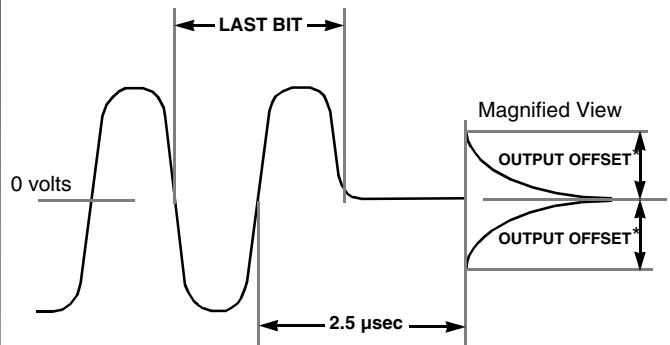

Figure 4 – Transmitter (TX) Output Offset



*Offset measured at point A-A' in Fig 5

Figure 5 – Typical Transformer Connection

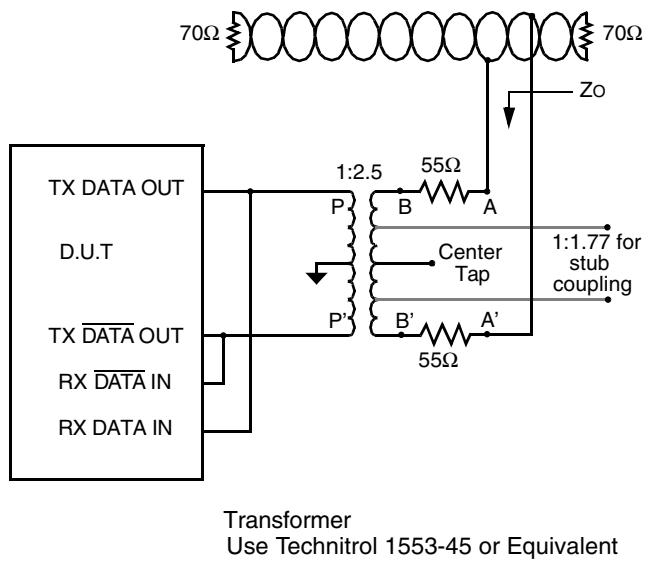
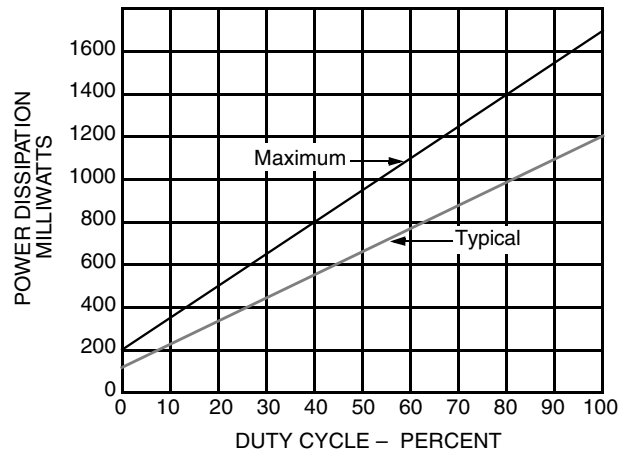
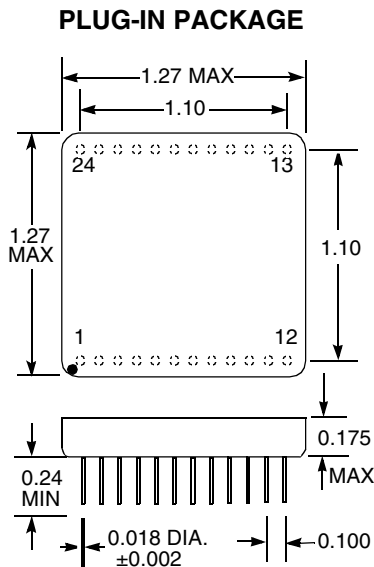

Figure 6 – Power Dissipation vs. Duty Cycle



Note: Vcc = 5 Volts, Vbus (pt A-A') at 7.5 Volts P-P



Pin Connections

1. TX DATA OUT
2. TX DATA OUT
3. TX GND (+5)
4. N.C.
5. N.C.
6. N.C.
7. RX DATA OUT
8. STROBE
9. RX GND (+5V)
10. RXDATA OUT
11. N.C.
12. N.C.
13. N.C.
14. N.C.
15. RX DATA IN
16. RX DATA IN
17. GND
18. CASE GND
19. N.C.
20. +5V
21. TX INHIBIT
22. TX DATA IN
23. TX DATA IN
24. N.C.

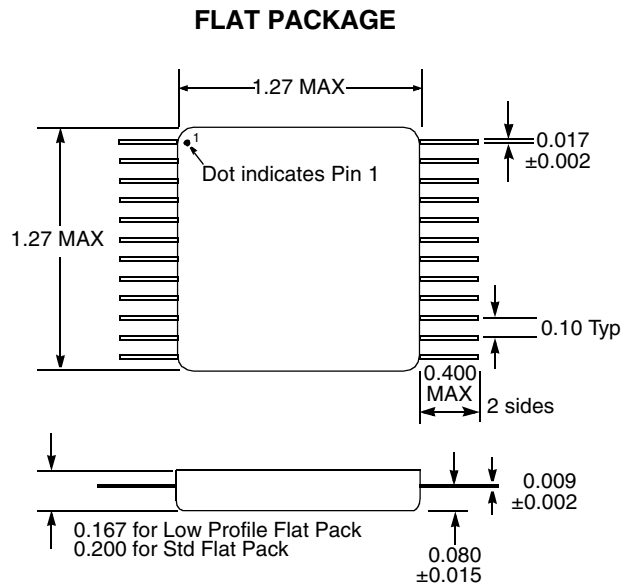

Notes

1. Dimensions shown are in inches
2. Pins are equally spaced at 0.10.0±0.002 tolerance, non-cumulative, each row.

Configurations and Ordering Information

Model No.	DESC No.	Receiver Data level	Case	Specs.	Configuration
ACT4419	Pending	Normally Low	Plug In	1553 & 1760	Single
ACT4419FP	Pending	Normally Low	Flat Pack	1553 & 1760	Single

Specifications subject to change without notice.

Aeroflex Circuit Technology
35 South Service Road
Plainview New York 11803

Telephone: (516) 694-6700
FAX: (516) 694-6715
Toll Free Inquiries: 1-(800)THE-1553