

Small Surface Mount Fast Diodes

Features

- For surface mounted applications
- Low profile package
- Ideal for automated placement
- Glass passivated
- High temperature soldering:
260 °C/ 10 seconds at terminals

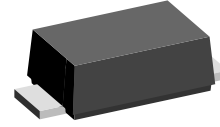

17249

Mechanical Data

Case: JEDEC -DO219-AB (SMF[®]) Plastic case

Polarity: Band denotes cathode end

Weight: approx. 0.01 g

Packaging codes-options:

GS18 -10 K per 13" reel (8 mm tape), 50 K/box

GS08 -3 K per 7" reel (8 mm tape), 30 K/box

Parts Table

Part	Marking
RS07B	RB
RS07D	RD
RS07G	RG
RS07J	RJ

Absolute Maximum Ratings

T_{amb} = 25 °C, unless otherwise specified

Parameter	Test condition	Part	Symbol	Value	Unit
Maximum repetitive peak reverse voltage		RS07B	V _{RRM}	100	V
		RS07D	V _{RRM}	200	V
		RS07G	V _{RRM}	400	V
		RS07J	V _{RRM}	600	V
Maximum RMS voltage		RS07B	V _{RMS}	70	V
		RS07D	V _{RMS}	140	V
		RS07G	V _{RMS}	280	V
		RS07J	V _{RMS}	420	V
Maximum DC blocking voltage		RS07B	V _{DC}	100	V
		RS07D	V _{DC}	200	V
		RS07G	V _{DC}	400	V
		RS07J	V _{DC}	600	V
Maximum average forward rectified current	T _{tp} = 65 °C		I _{F(AV)}	1.4	A
	T _A = 45 °C		I _{F(AV)}	0.5	A

Thermal Characteristics

$T_{amb} = 25\text{ }^{\circ}\text{C}$, unless otherwise specified

Parameter	Test condition	Symbol	Value	Unit
Thermal resistance junction to ambient air ¹⁾		$R_{\theta JA}$	180	K/W
Operating junction and storage temperature range		T_J, T_{STG}	- 55 to + 150	$^{\circ}\text{C}$

¹⁾ Mounted on epoxy glass PCB with 3 x 3 mm, Cu pads ($\geq 40\text{ }\mu\text{m}$ thick)

Electrical Characteristics

$T_{amb} = 25\text{ }^{\circ}\text{C}$, unless otherwise specified

Parameter	Test condition	Part	Symbol	Min	Typ.	Max	Unit
Maximum instantaneous forward voltage	0.7 A ²⁾		V_F			1.15	V
Maximum DC reverse current at rated DC blocking voltage	$T_A = 25\text{ }^{\circ}\text{C}$		I_R			10	μA
	$T_A = 125\text{ }^{\circ}\text{C}$		I_R			50	μA
Reverse recovery time	$I_F = 0.5\text{ A}, I_R = 1\text{ A}, I_{rr} = 0.25\text{ A}$	RS07B	t_{rr}			150	ns
		RS07D	t_{rr}			150	ns
		RS07G	t_{rr}			150	ns
		RS07J	t_{rr}			250	ns
Typical capacitance	4 V, 1 MHz		C_J		9		pF

²⁾ Pulse test, 300 μs pulse width 1 % duty cycle

Typical Characteristics ($T_{amb} = 25\text{ }^{\circ}\text{C}$ unless otherwise specified)

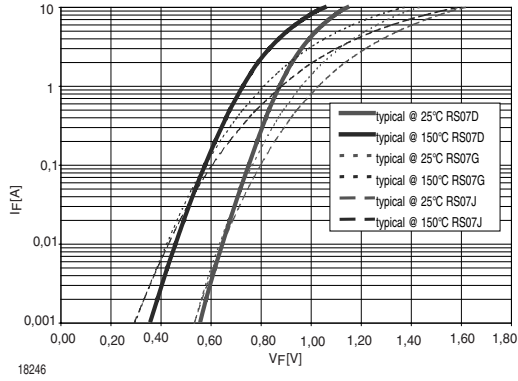

Figure 1. Typical Forward Characteristics

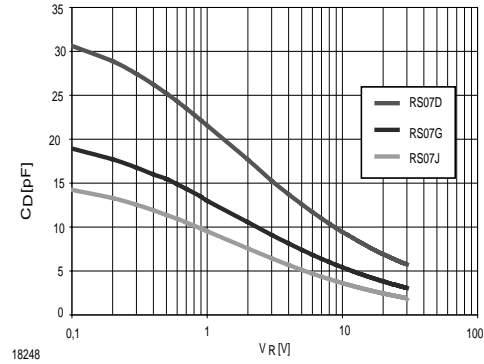

Figure 3. Typ. Diode Capacitance vs. Reverse Voltage

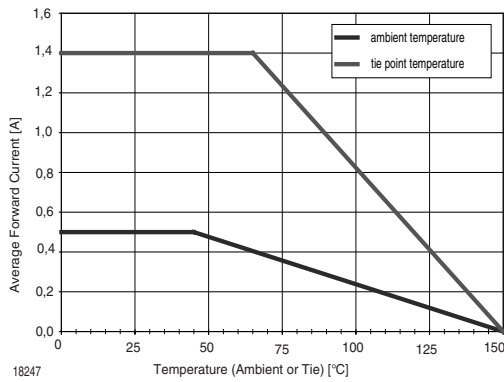

Figure 2. Forward Current Derating Curve

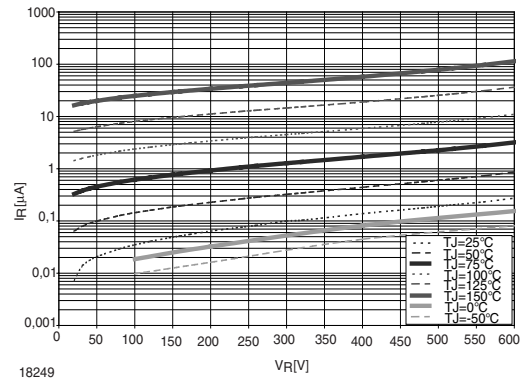

Figure 4. Typical Reverse Characteristics

RS07B to RS07J

Vishay Semiconductors



Package Dimensions in mm

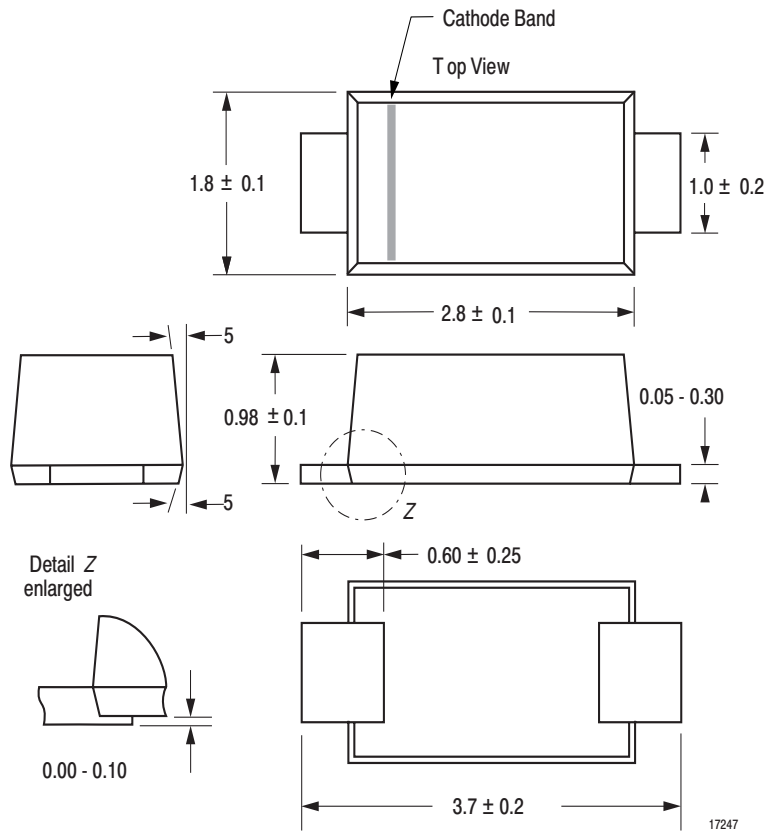

Mounting Pad Layout

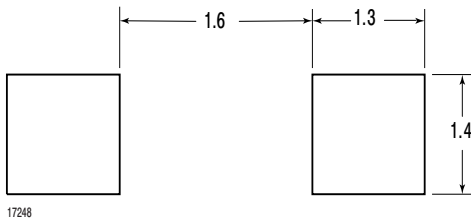



Ozone Depleting Substances Policy Statement

It is the policy of **Vishay Semiconductor GmbH** to

1. Meet all present and future national and international statutory requirements.
2. Regularly and continuously improve the performance of our products, processes, distribution and operating systems with respect to their impact on the health and safety of our employees and the public, as well as their impact on the environment.

It is particular concern to control or eliminate releases of those substances into the atmosphere which are known as ozone depleting substances (ODSs).

The Montreal Protocol (1987) and its London Amendments (1990) intend to severely restrict the use of ODSs and forbid their use within the next ten years. Various national and international initiatives are pressing for an earlier ban on these substances.

Vishay Semiconductor GmbH has been able to use its policy of continuous improvements to eliminate the use of ODSs listed in the following documents.

1. Annex A, B and list of transitional substances of the Montreal Protocol and the London Amendments respectively
2. Class I and II ozone depleting substances in the Clean Air Act Amendments of 1990 by the Environmental Protection Agency (EPA) in the USA
3. Council Decision 88/540/EEC and 91/690/EEC Annex A, B and C (transitional substances) respectively.

Vishay Semiconductor GmbH can certify that our semiconductors are not manufactured with ozone depleting substances and do not contain such substances.

**We reserve the right to make changes to improve technical design
and may do so without further notice.**

Parameters can vary in different applications. All operating parameters must be validated for each customer application by the customer. Should the buyer use Vishay Semiconductors products for any unintended or unauthorized application, the buyer shall indemnify Vishay Semiconductors against all claims, costs, damages, and expenses, arising out of, directly or indirectly, any claim of personal damage, injury or death associated with such unintended or unauthorized use.

Vishay Semiconductor GmbH, P.O.B. 3535, D-74025 Heilbronn, Germany
Telephone: 49 (0)7131 67 2831, Fax number: 49 (0)7131 67 2423