

DC to DC Converters

Conformity to RoHS Directive

Insulated Type, Ultra Compact Size, 1.5 to 25W Output, 5-year Warranty Period

CC-E Series

FEATURES

- Compact size(almost half floor space of existing product).
- No tantalum capacitor and no aluminum electrolytic capacitor are used.
- All series are equipped with a built-in remote control function (except for SIP).
- Output voltage tolerance $\pm 3\%$ (under 10W, at single output).
- Light weight(no potting).
- It is a product conforming to RoHS directive.
- These are PWB halogen-free pc board.
- Both mountings of DIP type and SMD type are available.
- UL60950-1, C-UL CSA 60950-1 and EN60950-1 approved (partial approved).



PART NUMBERS AND RATINGS

Output power	Input voltage	Output voltage			
		3.3V	5V	12V(15V ^{*2})	$\pm 12V(15V^{*2})$ or 24V, 30V ^{*3}
1.5W	5V	CC1R5-0503Sx ^{*1} -E	CC1R5-0505Sx-E	CC1R5-0512Sx-E	CC1R5-0512Dx-E
	12V	CC1R5-1203Sx-E	CC1R5-1205Sx-E	CC1R5-1212Sx-E	CC1R5-1212Dx-E
	24V	CC1R5-2403Sx-E	CC1R5-2405Sx-E	CC1R5-2412Sx-E	CC1R5-2412Dx-E
	48V	CC1R5-4803Sx-E	CC1R5-4805Sx-E	CC1R5-4812Sx-E	CC1R5-4812Dx-E
3W	5V	CC3-0503Sx-E	CC3-0505Sx-E	CC3-0512Sx-E	CC3-0512Dx-E
	12V	CC3-1203Sx-E	CC3-1205Sx-E	CC3-1212Sx-E	CC3-1212Dx-E
	24V	CC3-2403Sx-E	CC3-2405Sx-E	CC3-2412Sx-E	CC3-2412Dx-E
	48V	CC3-4803Sx-E	CC3-4805Sx-E	CC3-4812Sx-E	CC3-4812Dx-E
6W	5V	CC6-0503Sx-E	CC6-0505Sx-E	CC6-0512Sx-E	CC6-0512Dx-E
	12V	CC6-1203Sx-E	CC6-1205Sx-E	CC6-1212Sx-E	CC6-1212Dx-E
	24V	CC6-2403Sx-E	CC6-2405Sx-E	CC6-2412Sx-E	CC6-2412Dx-E
	48V	CC6-4803Sx-E	CC6-4805Sx-E	CC6-4812Sx-E	CC6-4812Dx-E
10W	5V	CC10-0503Sx-E	CC10-0505Sx-E	CC10-0512Sx-E	CC10-0512Dx-E
	12V	CC10-1203Sx-E	CC10-1205Sx-E	CC10-1212Sx-E	CC10-1212Dx-E
	24V	CC10-2403Sx-E	CC10-2405Sx-E	CC10-2412Sx-E	CC10-2412Dx-E
	48V	CC10-4803Sx-E	CC10-4805Sx-E	CC10-4812Sx-E	CC10-4812Dx-E
15W	24V	CC15-2403Sx-E	CC15-2405Sx-E		
25W	24V	CC25-2403Sx-E	CC25-2405Sx-E		

*1 An "x" within the product name is to be replaced by the symbol representing the terminal structure (F: DIP / R: SMD / S: SIP).

Note that the SIP type is limited to 3W.

*2 The output voltage can be set to 15V, $\pm 15V$, by connecting the 12Vout, $\pm 12V$ TRM (output variable) to $-V_{out}$.

*3 24V single output is possible by opening the $\pm 12V_{out}$ COM terminal and connecting the load to $+V_{out}$, $-V_{out}$. Also, 30V single output is possible when connecting the TRM terminal with $-V_{out}$ under the same conditions.

PRODUCT IDENTIFICATIONS

CC3-0505SF-E

Form symbols

Output mode symbols

Output voltage

Input voltage

Output power

F: Horizontal DIP type

R: Horizontal SMD type

S: Vertical SIP type

S: Single output, D: Double output

03: 3.3V / 05: 5V / 12: 12V

05: 5V / 12: 12V / 24: 24V / 48: 48V

1R5: 1.5W / 3: 3W / 6: 6W / 10: 10W / 15: 15W / 25: 25W

- Conformity to RoHS Directive: This means that, in conformity with EU Directive 2002/95/EC, lead, cadmium, mercury, hexavalent chromium, and specific bromine-based flame retardants, PBB and PBDE, have not been used, except for exempted applications.

- All specifications are subject to change without notice.

CC1R5 Type

ELECTRICAL CHARACTERISTICS

Part No.	Input voltage (V)	Output voltage ² (V)	Output current (mA)	Voltage stability			Output ripple noise voltage ⁴ (mVp-p) typ./max.	Efficiency ⁵ (%)	Input-output insulation
				Input (mV)max.	Load ³ (mV)max.	Temperature (mV)max.			
CC1R5-0503Sx ¹ -E	4.5 to 9	3.3±3%	0 to 400	20	40	80	40/120	71	
CC1R5-0505Sx-E	4.5 to 9	5±3%	0 to 300	20	40	80	40/120	77	
CC1R5-0512Sx-E	4.5 to 9	12±3%	0 to 125	40	100	200	30/120	80	
	4.5 to 9	15±3% ^{*7}	0 to 100	40	100	200	30/120	80	
CC1R5-0512Dx-E ^{*6}	4.5 to 9	±12±5%	±0 to 60	80	600	300	30/120	79	
	4.5 to 9	±15±5% ^{*7}	±0 to 50	80	600	300	30/120	79	
CC1R5-1203Sx-E	9 to 18	3.3±3%	0 to 400	20	40	80	40/120	73	
CC1R5-1205Sx-E	9 to 18	5±3%	0 to 300	20	40	80	40/120	78	
CC1R5-1212Sx-E	9 to 18	12±3%	0 to 125	40	100	200	30/120	82	Withstand voltage AC.500V
	9 to 18	15±3% ^{*7}	0 to 100	40	100	200	30/120	82	
CC1R5-1212Dx-E ^{*6}	9 to 18	±12±5%	±0 to 60	80	600	300	30/120	81	1min
	9 to 18	±15±5% ^{*7}	±0 to 50	80	600	300	30/120	81	
CC1R5-2403Sx-E	18 to 36	3.3±3%	0 to 400	20	40	80	40/120	72	Resistance DC.500V
CC1R5-2405Sx-E	18 to 36	5±3%	0 to 300	20	40	80	40/120	77	
CC1R5-2412Sx-E	18 to 36	12±3%	0 to 125	40	100	200	30/120	81	50MΩ min.
	18 to 36	15±3% ^{*7}	0 to 100	40	100	200	30/120	81	
CC1R5-2412Dx-E ^{*6}	18 to 36	±12±5%	±0 to 60	80	600	300	30/120	79	
	18 to 36	±15±5% ^{*7}	±0 to 50	80	600	300	30/120	79	
CC1R5-4803Sx-E	36 to 76	3.3±3%	0 to 400	20	40	80	40/120	70	
CC1R5-4805Sx-E	36 to 76	5±3%	0 to 300	20	40	80	40/120	76	
CC1R5-4812Sx-E	36 to 76	12±3%	0 to 125	40	100	200	30/120	80	
	36 to 76	15±3% ^{*7}	0 to 100	40	100	200	30/120	80	
CC1R5-4812Dx-E ^{*6}	36 to 76	±12±5%	±0 to 60	80	600	300	30/120	79	
	36 to 76	±15±5% ^{*7}	±0 to 50	80	600	300	30/120	79	

*1 An "x" within the product name is to be replaced by the symbol representing the terminal structure (F: DIP / R: SMD).

*2 Total output voltage is including input, load, and temperature regulation.

*3 When the condition is 2-output, it is the balance load (balance load means the condition when the load current of +output and -output is equal).

*4 Measurement bandwidth: 50MHz

*5 Typical input voltage, maximum output current.

*6 2-output products may be used as 24 to 30V single output with COM. terminal open.

*7 TRM and -Vout are shorted.

• Trim range: 3.3Vout is 3.15 to 3.6V, 5Vout is 4.75 to 6V, 12Vout is 11.4 to 15V, ±12Vout is ±11.4 to ±15V (22.8 to 30V).

OUTPUT POWER - AMBIENT TEMPERATURE(DERATING)

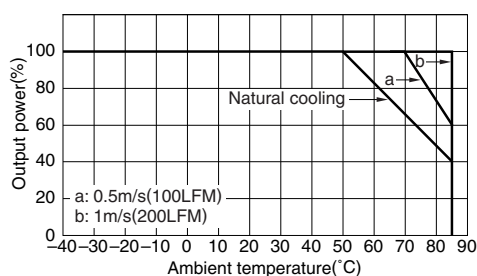

COMMON SPECIFICATIONS

Overcurrent protection	Output current limitation system, auto recovery type
Operating temperature range	-40 to +85°C[Derating is necessary when operating environment temperature exceed 50°C]
Storage temperature range	-40 to +85°C
Humidity range	95(%)RH max. [Maximum wet-bulb temperature: 38°C]
Vibration	10 to 55Hz, all amplitude 1.52mm, sweep time 15min[3 directions of X, Y, Z, each 2h]
Amplitude	980m/s ² (100G) 6ms[6 directions, each 3 times]
Withstand voltage Eac	Input to output, input to case, output to case: 500V, 1min
Insulation resistance	Input to output, input to case, output to case: 50MΩ min.[DC.500V]
Safety standards	UL60950-1, C-UL(CSA22.2 No.60950-1), EN60950-1 certified
Weight	3.2g

• All specifications are subject to change without notice.

CC1R5 Type

SHAPES AND DIMENSIONS CC1R5-xxxxx-E (DIP TYPE)

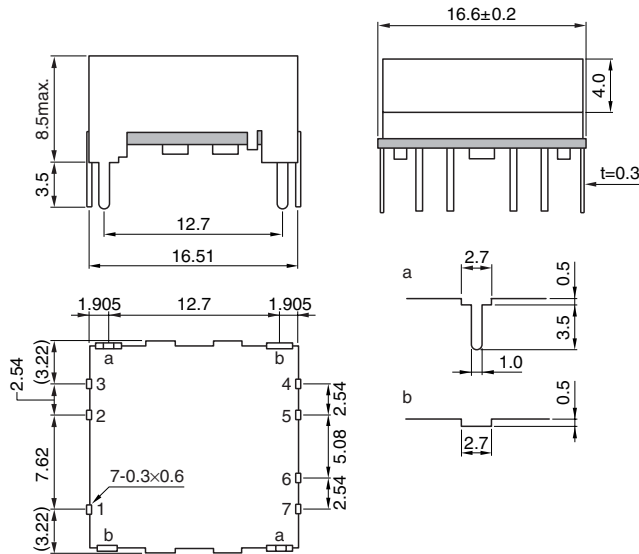

RECOMMENDED PWB HOLE SIZE, LOCATION [TOP VIEW]

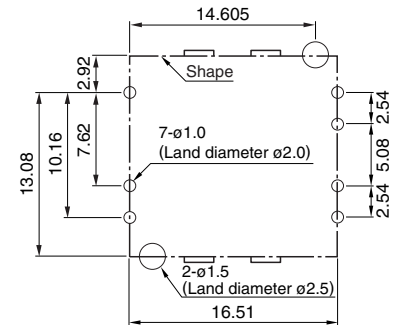

Dimensions in mm
Tolerance: ±0.5

CC1R5-xxxxxR-E (SMD TYPE)

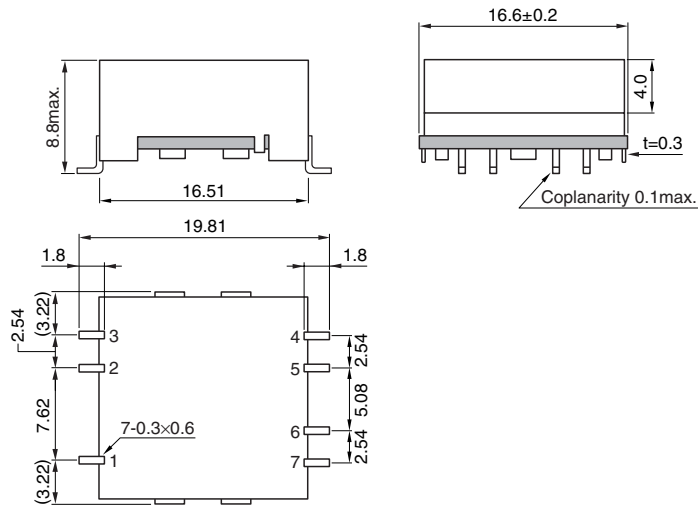

RECOMMENDED PWB HOLE SIZE, LOCATION [TOP VIEW]

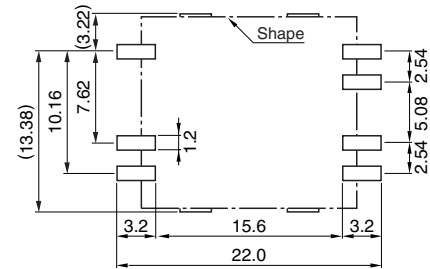

Dimensions in mm
Tolerance: ±0.5

CONNECTIONS

CC1R5-xxxxSx-E

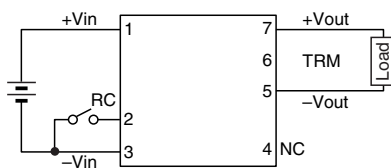

TERMINAL PIN CONFIGURATION

No.1	+Vin
No.2	RC
No.3	-Vin
No.4	NC
No.5	-Vout
No.6	TRM
No.7	+Vout

CC1R5-xxxxDx-E

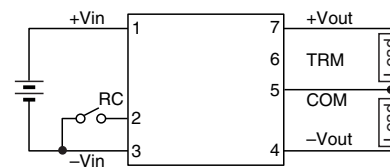

TERMINAL PIN CONFIGURATION

No.1	+Vin
No.2	RC
No.3	-Vin
No.4	-Vout
No.5	Common out
No.6	TRM
No.7	+Vout

CC3 Type(DIP, SMD Types)

ELECTRICAL CHARACTERISTICS

Part No.	Input voltage (V)	Output voltage ^{*2} (V)	Output current (mA)	Voltage stability			Output ripple noise voltage ^{*4} (mVp-p) typ./max.	Efficiency ^{*5} (%)	Input-output insulation
				Input (mV)max.	Load ^{*3} (mV)max.	Temperature (mV)max.			
CC3-0503Sx ^{*1} -E	4.5 to 9	3.3±3%	0 to 800	20	40	80	40/120	73	
CC3-0505Sx-E	4.5 to 9	5±3%	0 to 600	20	40	80	40/120	77	
CC3-0512Sx-E	4.5 to 9	12±3%	0 to 250	40	100	200	30/120	82	
	4.5 to 9	15±3% ^{*7}	0 to 200	40	100	200	30/120	82	
CC3-0512Dx-E ^{*6}	4.5 to 9	±12±5%	±0 to 125	80	600	300	30/120	81	
	4.5 to 9	±15±5% ^{*7}	±0 to 100	80	600	300	30/120	81	
CC3-1203Sx-E	9 to 18	3.3±3%	0 to 800	20	40	80	40/120	74	
CC3-1205Sx-E	9 to 18	5±3%	0 to 600	20	40	80	40/120	79	
CC3-1212Sx-E	9 to 18	12±3%	0 to 250	40	100	200	30/120	82	Withstand voltage AC.500V
	9 to 18	15±3% ^{*7}	0 to 200	40	100	200	30/120	82	
CC3-1212Dx-E ^{*6}	9 to 18	±12±5%	±0 to 125	80	600	300	30/120	81	Resistance 1min
	9 to 18	±15±5% ^{*7}	±0 to 100	80	600	300	30/120	81	
CC3-2403Sx-E	18 to 36	3.3±3%	0 to 800	20	40	80	40/120	73	Resistance DC.500V
CC3-2405Sx-E	18 to 36	5±3%	0 to 600	20	40	80	40/120	78	
CC3-2412Sx-E	18 to 36	12±3%	0 to 250	40	100	200	30/120	82	50MΩ min.
	18 to 36	15±3% ^{*7}	0 to 200	40	100	200	30/120	82	
CC3-2412Dx-E ^{*6}	18 to 36	±12±5%	±0 to 125	80	600	300	30/120	81	
	18 to 36	±15±5% ^{*7}	±0 to 100	80	600	300	30/120	81	
CC3-4803Sx-E	36 to 76	3.3±3%	0 to 800	20	40	80	40/120	73	
CC3-4805Sx-E	36 to 76	5±3%	0 to 600	20	40	80	40/120	79	
CC3-4812Sx-E	36 to 76	12±3%	0 to 250	40	100	200	30/120	81	
	36 to 76	15±3% ^{*7}	0 to 200	40	100	200	30/120	81	
CC3-4812Dx-E ^{*6}	36 to 76	±12±5%	±0 to 125	80	600	300	30/120	80	
	36 to 76	±15±5% ^{*7}	±0 to 100	80	600	300	30/120	80	

*1 An "x" within the product name is to be replaced by the symbol representing the terminal structure (F: DIP / R: SMD).

*2 Total output voltage is including input, load, and temperature regulation.

*3 When the condition is 2-output, it is the balance load (balance load means the condition when the load current of +output and -output is equal).

*4 Measurement bandwidth: 50MHz

*5 Typical input voltage, maximum output current.

*6 2-output products may be used as 24 to 30V single output with COM. terminal open.

*7 TRM and -Vout are shorted.

• Trim range: 3.3Vout is 3.15 to 3.6V, 5Vout is 4.75 to 6V, 12Vout is 11.4 to 15V, ±12Vout is ±11.4 to ±15V.

OUTPUT POWER - AMBIENT TEMPERATURE(DERATING)

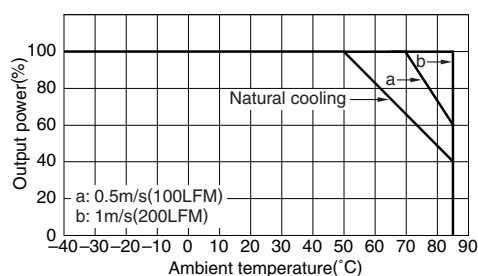

COMMON SPECIFICATIONS

Overcurrent protection	Output current limitation system, auto recovery type
Operating temperature range	-40 to +85°C[Derating is necessary when operating environment temperature exceed 50°C]
Storage temperature range	-40 to +85°C
Humidity range	95(%)RH max. [Maximum wet-bulb temperature: 38°C]
Amplitude	10 to 55Hz, all amplitude 1.52mm, sweep time 15min[3 directions of X, Y, Z, each 2h]
Vibration	980m/s ² (100G) 6ms[6 directions, each 3 times]
Withstand voltage Eac	Input to output, input to case, output to case: 500V, 1min
Insulation resistance	Input to output, input to case, output to case: 50MΩ min.[DC.500V]
Safety standards	UL60950-1, C-UL(CSA22.2 No.60950-1), EN60950-1 certified
Weight	4.5g

• All specifications are subject to change without notice.

CC3 Type(SIP Type)

ELECTRICAL CHARACTERISTICS

Part No.	Input voltage (V)	Output voltage* ¹ (V)	Output current (mA)	Voltage stability			Output ripple noise voltage* ³ (mVp-p) typ./max.	Efficiency* ⁴ (%)	Input-output insulation
				Input (mV)max.	Load* ² (mV)max.	Temperature (mV)max.			
CC3-0503SS-E	4.5 to 9	3.3±3%	0 to 800	20	40	80	40/120	73	
CC3-0505SS-E	4.5 to 9	5±3%	0 to 600	20	40	80	40/120	77	
CC3-0512SS-E	4.5 to 9	12±3%	0 to 250	40	100	200	30/120	82	
	4.5 to 9	15±3%* ⁶	0 to 200	40	100	200	30/120	82	
CC3-0512DS-E* ⁵	4.5 to 9	±12±5%	±0 to 125	80	600	300	30/120	81	
	4.5 to 9	±15±5%* ⁶	±0 to 100	80	600	300	30/120	81	
CC3-1203SS-E	9 to 18	3.3±3%	0 to 800	20	40	80	40/120	73	
CC3-1205SS-E	9 to 18	5±3%	0 to 600	20	40	80	40/120	79	
CC3-1212SS-E	9 to 18	12±3%	0 to 250	40	100	200	30/120	82	Withstand voltage AC.500V 1min
	9 to 18	15±3%* ⁶	0 to 200	40	100	200	30/120	82	
CC3-1212DS-E* ⁵	9 to 18	±12±5%	±0 to 125	80	600	300	30/120	82	Resistance DC.500V 50MΩ min.
	9 to 18	±15±5%* ⁶	±0 to 100	80	600	300	30/120	82	
CC3-2403SS-E	18 to 36	3.3±3%	0 to 800	20	40	80	40/120	73	
CC3-2405SS-E	18 to 36	5±3%	0 to 600	20	40	80	40/120	78	
CC3-2412SS-E	18 to 36	12±3%	0 to 250	40	100	200	30/120	82	
	18 to 36	15±3%* ⁶	0 to 200	40	100	200	30/120	82	
CC3-2412DS-E* ⁵	18 to 36	±12±5%	±0 to 125	80	600	300	30/120	81	
	18 to 36	±15±5%* ⁶	±0 to 100	80	600	300	30/120	81	
CC3-4803SS-E	36 to 76	3.3±3%	0 to 800	20	40	80	40/120	73	
CC3-4805SS-E	36 to 76	5±3%	0 to 600	20	40	80	40/120	79	
CC3-4812SS-E	36 to 76	12±3%	0 to 250	40	100	200	30/120	82	
	36 to 76	15±3%* ⁶	0 to 200	40	100	200	30/120	82	
CC3-4812DS-E* ⁵	36 to 76	±12±5%	±0 to 125	80	600	300	30/120	82	
	36 to 76	±15±5%* ⁶	±0 to 100	80	600	300	30/120	82	

*1 Total output voltage is including input, load, and temperature regulation.

*2 When the condition is 2-output, it is the balance load (balance load means the condition when the load current of +output and -output is equal).

*3 Measurement bandwidth: 50MHz

*4 Typical input voltage, maximum output current.

*5 2-output products may be used as 24 to 30V single output with COM. terminal open.

*6 TRM and -Vout are shorted.

• Trim range: 3.3Vout is 3.15 to 3.67V, 5Vout is 4.75 to 6V, 12Vout is 11.4 to 15V, ±12Vout is ±11.4 to ±15V.

OUTPUT POWER - AMBIENT TEMPERATURE(DERATING)

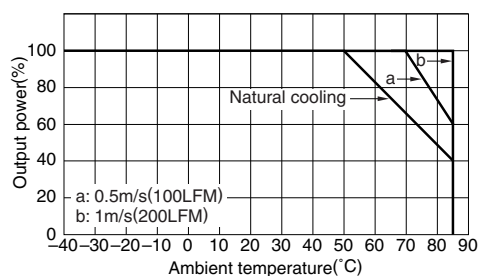

COMMON SPECIFICATIONS

Overcurrent protection	Output current limitation system, auto recovery type
Operating temperature range	-40 to +85°C[Derating is necessary when operating environment temperature exceed 50°C]
Storage temperature range	-40 to +85°C
Humidity range	95(%)RH max. [Maximum wet-bulb temperature: 38°C]
Amplitude	10 to 55Hz, all amplitude 1.52mm, sweep time 15min[3 directions of X, Y, Z, each 2h]
Vibration	980m/s ² (100G) 6ms[6 directions, each 3 times]
Withstand voltage Eac	Input to output, input to case, output to case: 500V, 1min
Insulation resistance	Input to output, input to case, output to case: 50MΩ min.[DC.500V]
Safety standards	UL60950-1, C-UL(CSA22.2 No.60950-1), EN60950-1 certified is applying partially.
Weight	7.0g

• All specifications are subject to change without notice.

CC3 Type(DIP, SMD Types)

SHAPES AND DIMENSIONS

CC3-xxxxF-E (DIP TYPE)

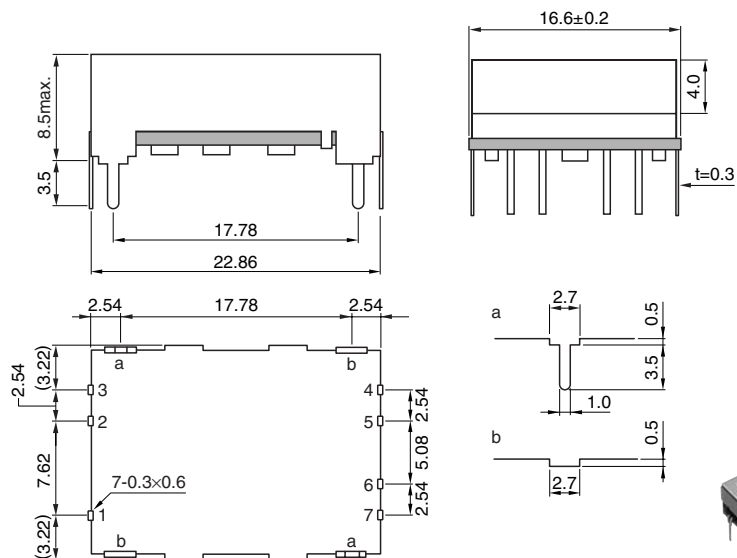

RECOMMENDED PWB HOLE SIZE, LOCATION [TOP VIEW]

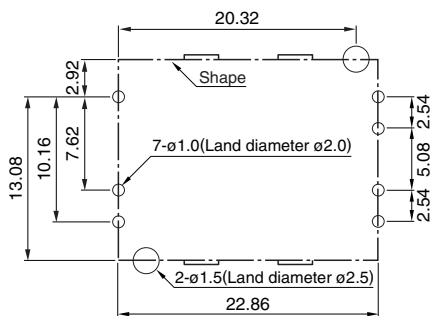

Dimensions in mm
Tolerance: ±0.5

CC3-xxxxR-E (SMD TYPE)

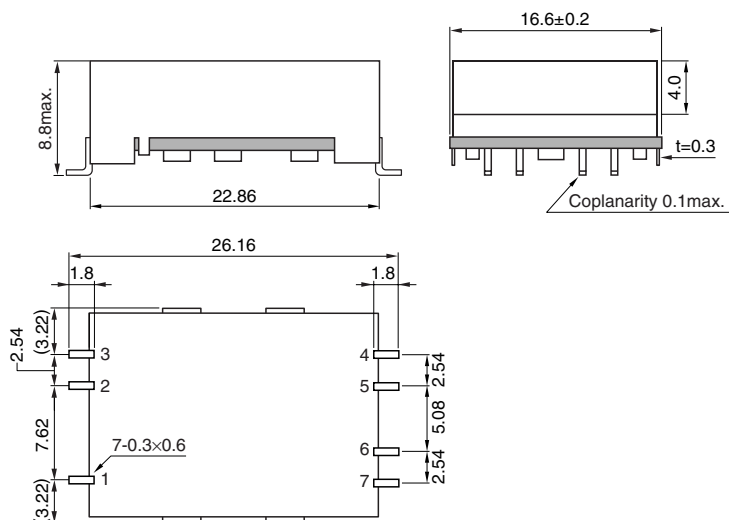

RECOMMENDED PWB HOLE SIZE, LOCATION [TOP VIEW]

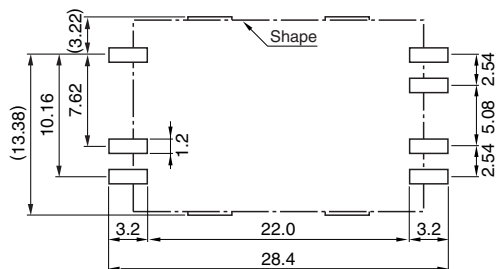

Dimensions in mm
Tolerance: ±0.5

CONNECTIONS

CC3-xxxxSx-E

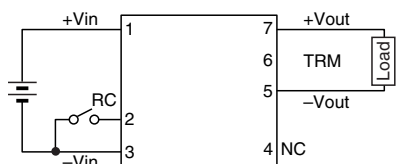

TERMINAL PIN CONFIGURATION

No.1	+Vin
No.2	RC
No.3	-Vin
No.4	NC
No.5	-Vout
No.6	TRM
No.7	+Vout

CC3-xxxxDx-E

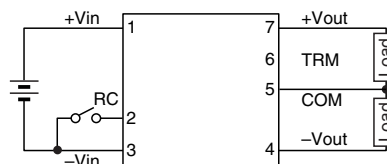

TERMINAL PIN CONFIGURATION

No.1	+Vin
No.2	RC
No.3	-Vin
No.4	-Vout
No.5	Common out
No.6	TRM
No.7	+Vout

• All specifications are subject to change without notice.

CC3 Type(SIP Type)

SHAPES AND DIMENSIONS

CC3-xxxxS-E (SIP TYPE)

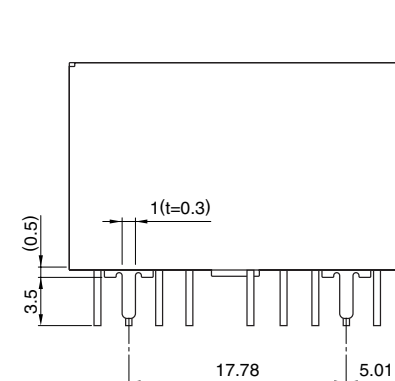
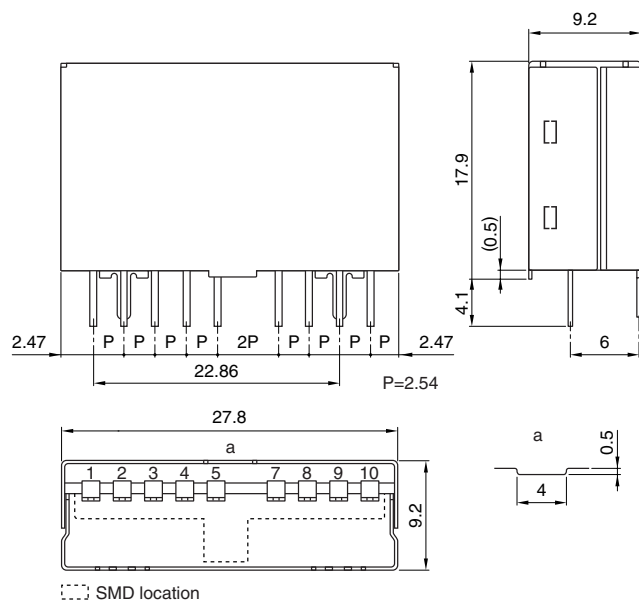

RECOMMENDED PWB HOLE SIZE, LOCATION [TOP VIEW]

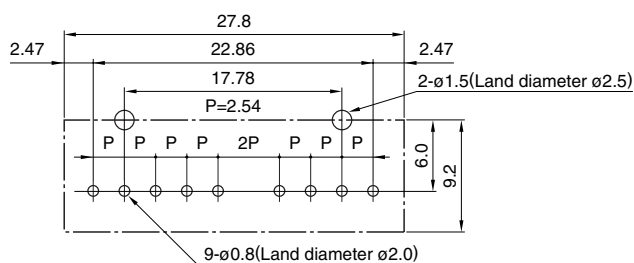

Dimensions in mm
Tolerance: ± 0.5

CONNECTIONS

CC3-xxxxSS-E

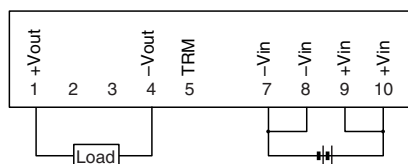

TERMINAL PIN CONFIGURATION

No.1	+Vout
No.2	NC
No.3	NC
No.4	-Vout
No.5	TRM
No.6	NC
No.7	-Vin
No.8	-Vin
No.9	+Vin
No.10	+Vin

CC3-xxxxDS-E

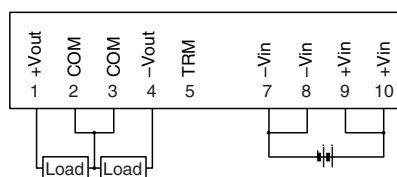

TERMINAL PIN CONFIGURATION

No.1	+Vout
No.2	COM
No.3	COM
No.4	-Vout
No.5	TRM
No.6	NC
No.7	-Vin
No.8	-Vin
No.9	+Vin
No.10	+Vin

The output voltage can be set to 15V, $\pm 15V$, by connecting the output variable terminal TRM of the 12Vout, $\pm 12V$ output model to -Vout. 24V single output is possible by opening the $\pm 12V$ out COM terminal and connecting the load to +Vout, -Vout. Also, 30V single output is possible when connecting the TRM terminal with -Vout under the same conditions.

CC6 Type

ELECTRICAL CHARACTERISTICS

Part No.	Input voltage (V)	Output voltage ^{*2} (V)	Output current (mA)	Voltage stability			Output ripple noise voltage ^{*4} (mVp-p) typ./max.	Efficiency ^{*5} (%)	Input-output insulation
				Input (mV)max.	Load ^{*3} (mV)max.	Temperature (mV)max.			
CC6-0503Sx ^{*1} -E	4.5 to 9	3.3±3%	0 to 1200	20	40	80	40/120	76	
CC6-0505Sx-E	4.5 to 9	5±3%	0 to 1000	20	40	80	40/120	79	
CC6-0512Sx-E	4.5 to 9	12±3%	0 to 500	40	100	200	30/120	82	
	4.5 to 9	15±3% ^{*7}	0 to 400	40	100	200	30/120	82	
CC6-0512Dx-E ^{*6}	4.5 to 9	±12±5%	±0 to 250	80	600	300	30/120	82	
	4.5 to 9	±15±5% ^{*7}	±0 to 200	80	600	300	30/120	82	
CC6-1203Sx-E	9 to 18	3.3±3%	0 to 1200	20	40	80	40/120	78	
CC6-1205Sx-E	9 to 18	5±3%	0 to 1200	20	40	80	40/120	82	
CC6-1212Sx-E	9 to 18	12±3%	0 to 500	40	100	200	30/120	85	Withstand voltage AC.500V 1min
	9 to 18	15±3% ^{*7}	0 to 400	40	100	200	30/120	85	
CC6-1212Dx-E ^{*6}	9 to 18	±12±5%	±0 to 250	80	600	300	30/120	85	Resistance DC.500V 50MΩ min.
	9 to 18	±15±5% ^{*7}	±0 to 200	80	600	300	30/120	85	
CC6-2403Sx-E	18 to 36	3.3±3%	0 to 1200	20	40	80	40/120	77	
CC6-2405Sx-E	18 to 36	5±3%	0 to 1200	20	40	80	40/120	81	
CC6-2412Sx-E	18 to 36	12±3%	0 to 500	40	100	200	30/120	87	
	18 to 36	15±3% ^{*7}	0 to 400	40	100	200	30/120	87	
CC6-2412Dx-E ^{*6}	18 to 36	±12±5%	±0 to 250	80	600	300	30/120	86	
	18 to 36	±15±5% ^{*7}	±0 to 200	80	600	300	30/120	86	
CC6-4803Sx-E	36 to 76	3.3±3%	0 to 1200	20	40	80	40/120	77	
CC6-4805Sx-E	36 to 76	5±3%	0 to 1200	20	40	80	40/120	81	
CC6-4812Sx-E	36 to 76	12±3%	0 to 500	40	100	200	30/120	86	
	36 to 76	15±3% ^{*7}	0 to 400	40	100	200	30/120	86	
CC6-4812Dx-E ^{*6}	36 to 76	±12±5%	±0 to 250	80	600	300	30/120	86	
	36 to 76	±15±5% ^{*7}	±0 to 200	80	600	300	30/120	86	

*1 An "x" within the product name is to be replaced by the symbol representing the terminal structure (F: DIP / R: SMD).

*2 Total output voltage is including input, load, and temperature regulation.

*3 When the condition is 2-output, it is the balance load (balance load means the condition when the load current of +output and -output is equal).

*4 Measurement bandwidth: 50MHz

*5 Typical input voltage, maximum output current

*6 2-output products may be used as 24 to 30V single output with COM. terminal open.

*7 TRM and -Vout are shorted.

• Trim range: 3.3Vout is 3.15 to 3.6V, 5Vout is 4.75 to 6V, 12Vout is 11.4 to 15V, ±12Vout is ±11.4 to ±15V.

OUTPUT POWER - AMBIENT TEMPERATURE(DERATING)

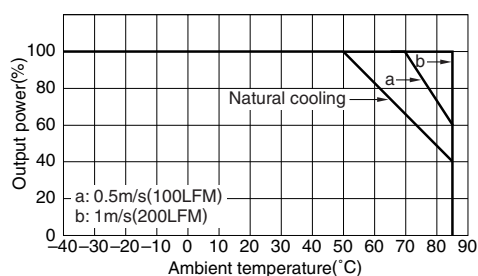

COMMON SPECIFICATIONS

Overcurrent protection	Output current limitation system, auto recovery type
Operating temperature range	-40 to +85°C [Derating is necessary when operating environment temperature exceed 50°C]
Storage temperature range	-40 to +85°C
Humidity range	95(%)RH max. [Maximum wet-bulb temperature: 38°C]
Amplitude	10 to 55Hz, all amplitude 1.52mm, sweep time 15min[3 directions of X, Y, Z, each 2h]
Vibration	980m/s ² (100G) 6ms[6 directions, each 3 times]
Withstand voltage Eac	Input to output, input to case, output to case: 500V, 1min
Insulation resistance	Input to output, input to case, output to case: 50MΩ min.[DC.500V]
Safety standards	UL60950-1, C-UL(CSA22.2 No.60950-1), EN60950-1 certified
Weight	5.8g

• All specifications are subject to change without notice.

CC6 Type

SHAPES AND DIMENSIONS

CC6-xxxxxF-E (DIP TYPE)

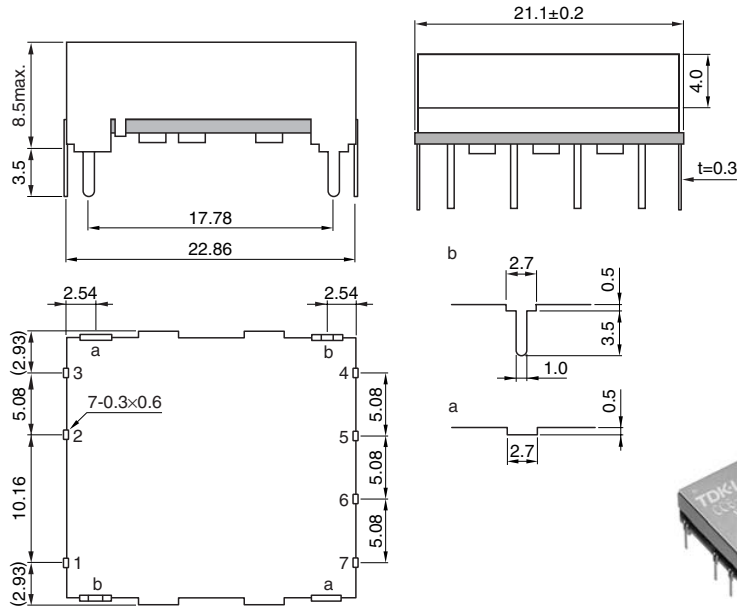

RECOMMENDED PWB HOLE SIZE, LOCATION [TOP VIEW]

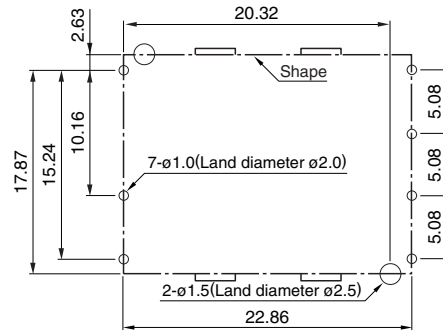

Dimensions in mm
Tolerance: ±0.5



CC6-xxxxxR-E (SMD TYPE)

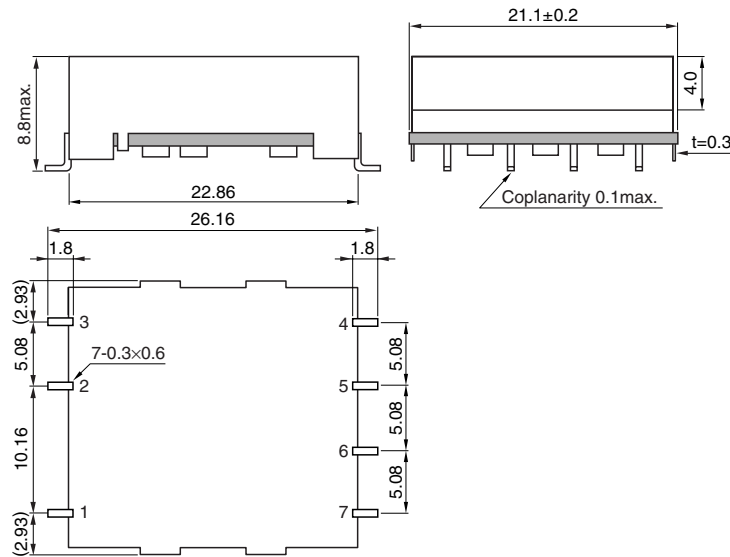

RECOMMENDED PWB HOLE SIZE, LOCATION [TOP VIEW]

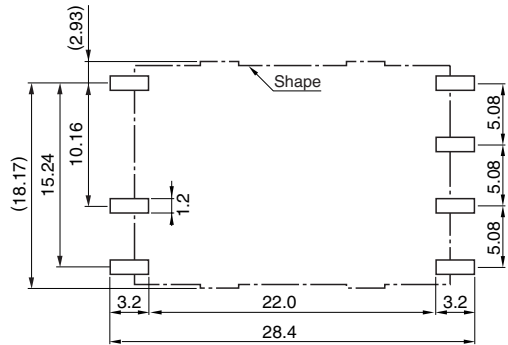

Dimensions in mm
Tolerance: ±0.5

CONNECTIONS

CC6-xxxxSx-E

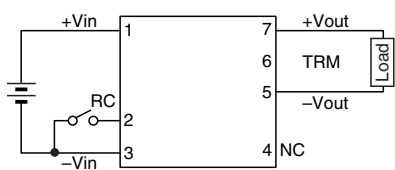

TERMINAL PIN CONFIGURATION

No.1	+Vin
No.2	RC
No.3	-Vin
No.4	NC
No.5	-Vout
No.6	TRM
No.7	+Vout

CC6-xxxxDx-E

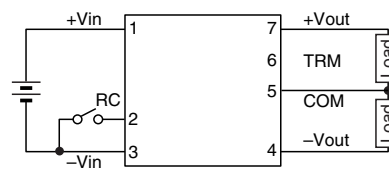

TERMINAL PIN CONFIGURATION

No.1	+Vin
No.2	RC
No.3	-Vin
No.4	-Vout
No.5	Common out
No.6	TRM
No.7	+Vout

• All specifications are subject to change without notice.

CC10 Type

ELECTRICAL CHARACTERISTICS

Part No.	Input voltage (V)	Output voltage ^{*2} (V)	Output current (mA)	Voltage stability			Output ripple noise voltage ^{*4} (mVp-p) typ./max.	Efficiency ^{*5} (%)	Input-output insulation
				Input (mV)max.	Load ^{*3} (mV)max.	Temperature (mV)max.			
CC10-0503Sx ^{*1} -E	4.5 to 9	3.3±3%	0 to 2500	20	40	80	40/120	84	
CC10-0505Sx-E	4.5 to 9	5±3%	0 to 2000	20	40	80	40/120	84	
CC10-0512Sx-E	4.5 to 9	12±3%	0 to 800	40	100	200	30/120	84	
	4.5 to 9	15±3% ^{*7}	0 to 640	40	100	200	30/120	84	
CC10-0512Dx-E ^{*6}	4.5 to 9	±12±5%	±0 to 400	80	600	300	30/120	83	
	4.5 to 9	±15±5% ^{*7}	±0 to 320	80	600	300	30/120	83	
CC10-1203Sx-E	9 to 18	3.3±3%	0 to 2500	20	40	80	40/120	84	
CC10-1205Sx-E	9 to 18	5±3%	0 to 2000	20	40	80	40/120	86	
CC10-1212Sx-E	9 to 18	12±3%	0 to 1000	40	100	200	30/120	88	Withstand voltage AC.500V
	9 to 18	15±3% ^{*7}	0 to 800	40	100	200	30/120	88	
CC10-1212Dx-E ^{*6}	9 to 18	±12±5%	±0 to 450	80	600	300	30/120	86	Resistance DC.500V
	9 to 18	±15±5% ^{*7}	±0 to 360	80	600	300	30/120	86	
CC10-2403Sx-E	18 to 36	3.3±3%	0 to 2500	20	40	80	40/120	84	50MΩ min.
CC10-2405Sx-E	18 to 36	5±3%	0 to 2000	20	40	80	40/120	86	
CC10-2412Sx-E	18 to 36	12±3%	0 to 1000	40	100	200	30/120	87	
	18 to 36	15±3% ^{*7}	0 to 800	40	100	200	30/120	87	
CC10-2412Dx-E ^{*6}	18 to 36	±12±5%	±0 to 450	80	600	300	30/120	86	
	18 to 36	±15±5% ^{*7}	±0 to 360	80	600	300	30/120	86	
CC10-4803Sx-E	36 to 76	3.3±3%	0 to 2500	20	40	80	40/120	84	
CC10-4805Sx-E	36 to 76	5±3%	0 to 2000	20	40	80	40/120	86	
CC10-4812Sx-E	36 to 76	12±3%	0 to 1000	40	100	200	30/120	88	
	36 to 76	15±3% ^{*7}	0 to 800	40	100	200	30/120	88	
CC10-4812Dx-E ^{*6}	36 to 76	±12±5%	±0 to 450	80	600	300	30/120	86	
	36 to 76	±15±5% ^{*7}	±0 to 360	80	600	300	30/120	86	

*1 An "x" within the product name is to be replaced by the symbol representing the terminal structure (F: DIP / R: SMD).

*2 Total output voltage is including input, load, and temperature regulation.

*3 When the condition is 2-output, it is the balance load (balance load means the condition when the load current of +output and -output is equal).

*4 Measurement bandwidth: 50MHz

*5 Typical input voltage, maximum output current

*6 2-output products may be used as 24 to 30V single output with COM. terminal open.

*7 TRM and -Vout are shorted.

• Trim range: 3.3Vout is 3.15 to 3.6V, 5Vout is 4.75 to 6V, 12Vout is 11.4 to 15V, ±12Vout is ±11.4 to ±15V.

OUTPUT POWER - AMBIENT TEMPERATURE(DERATING)

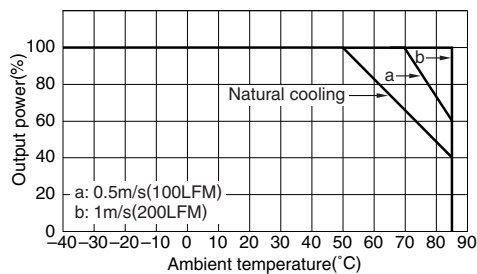

COMMON SPECIFICATIONS

Overcurrent protection	Output current limitation system, auto recovery type
Operating temperature range	-40 to +85°C[Derating is necessary when operating environment temperature exceed 50°C]
Storage temperature range	-40 to +85°C
Humidity range	95(%)RH max. [Maximum wet-bulb temperature: 38°C]
Amplitude	10 to 55Hz, all amplitude 1.52mm, sweep time 15min[3 directions of X, Y, Z, each 2h]
Vibration	980m/s ² (100G) 6ms[6 directions, each 3 times]
Withstand voltage Eac	Input to output, input to case, output to case: 500V, 1min
Insulation resistance	Input to output, input to case, output to case: 50MΩ min.[DC.500V]
Safety standards	UL60950-1, C-UL(CSA22.2 No.60950-1), EN60950-1 certified
Weight	10.0g

• All specifications are subject to change without notice.

CC10 Type

SHAPES AND DIMENSIONS

CC10-xxxxxF-E (DIP TYPE)

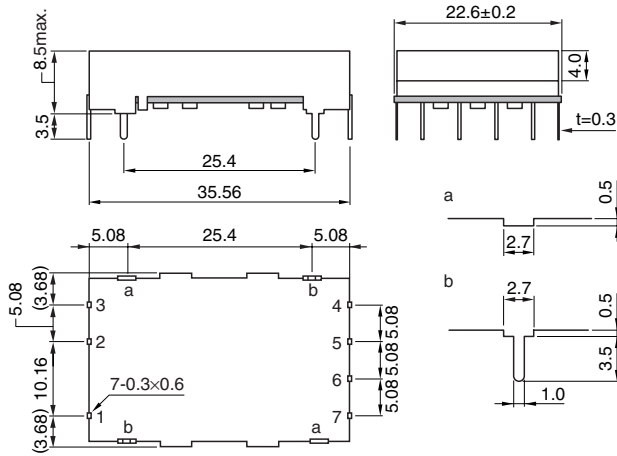

RECOMMENDED PWB HOLE SIZE, LOCATION [TOP VIEW]

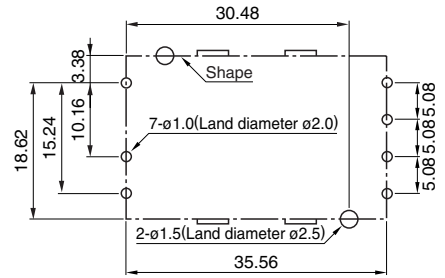

Dimensions in mm
Tolerance: ±0.5

CC10-xxxxxR-E (SMD TYPE)

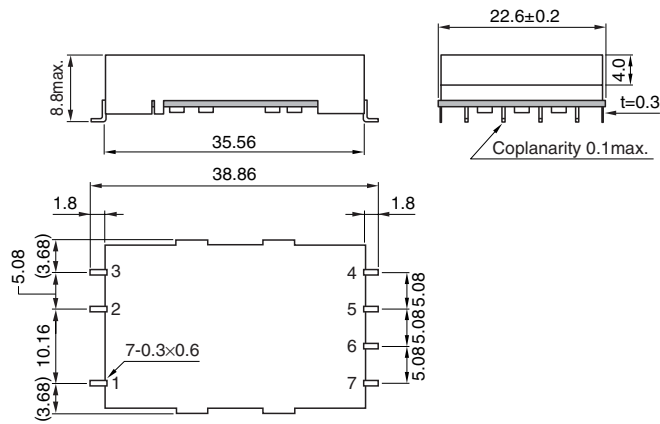

RECOMMENDED PWB HOLE SIZE, LOCATION [TOP VIEW]

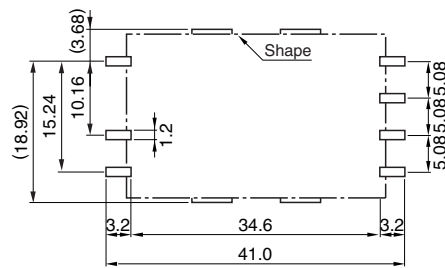

Dimensions in mm
Tolerance: ±0.5

CONNECTIONS

CC10-xxxxSx-E

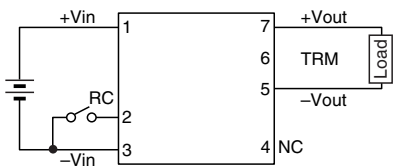

TERMINAL PIN CONFIGURATION

No.1	+Vin
No.2	RC
No.3	-Vin
No.4	NC
No.5	-Vout
No.6	TRM
No.7	+Vout

CC10-xxxxDx-E

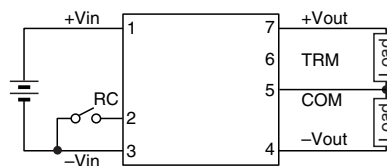

TERMINAL PIN CONFIGURATION

No.1	+Vin
No.2	RC
No.3	-Vin
No.4	-Vout
No.5	Common out
No.6	TRM
No.7	+Vout

• All specifications are subject to change without notice.

CC15 Type

ELECTRICAL CHARACTERISTICS

Part No.	Input voltage (V)	Output voltage*2 (V)	Output current (mA)	Voltage stability			Output ripple noise voltage*3 (mVp-p) typ./max.	Efficiency*4 (%)	Input-output insulation
				Input (mV)max.	Load (mV)max.	Temperature (mV)max.			
CC15-2403Sx*1-E	18 to 36	3.3/-3 to +5%	0 to 4500	40	120	80	40/120	89	Withstand voltage AC.500V 1min Resistance DC.500V 50MΩ min.
CC15-2405Sx-E	18 to 36	5.0/-3 to +5%	0 to 3000	50	200	80	40/120	89	

*1 An "x" within the product name is to be replaced by the symbol representing the terminal structure (F: DIP / R: SMD).

*2 Total output voltage is including input, load, and temperature regulation.

*3 Measurement bandwidth: 50MHz

*4 Typical input voltage, maximum output current

OUTPUT POWER - AMBIENT TEMPERATURE(DERATING)

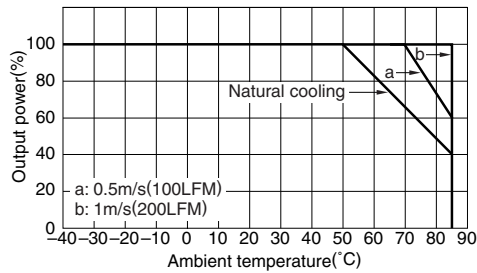

COMMON SPECIFICATIONS

Overcurrent protection	Output current limitation system, Output voltage shut-down type
Operating temperature range	-40 to +85°C [Derating is necessary when operating environment temperature exceed 50°C]
Storage temperature range	-40 to +85°C
Humidity range	95(%)RH max. [Maximum wet-bulb temperature: 38°C]
Amplitude	10 to 55Hz, all amplitude 1.52mm, sweep time 15min[3 directions of X, Y, Z, each 2h]
Vibration	980m/s ² (100G) 6ms[6 directions, each 3 times]
Withstand voltage Eac	Input to output, input to case, output to case: 500V, 1min
Insulation resistance	Input to output, input to case, output to case: 50MΩ min [DC.500V]
Safety standards	UL60950-1, C-UL(CSA22.2 No.60950-1), EN60950-1 certified
Weight	12.5g

CC15 Type

SHAPES AND DIMENSIONS

CC15-xxxxSF-E (DIP TYPE)

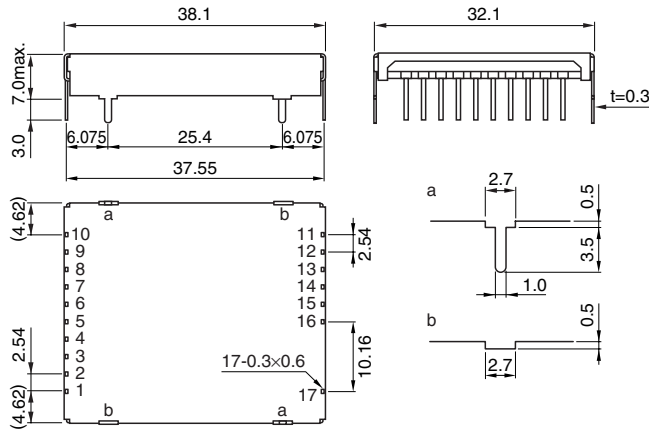

RECOMMENDED PWB HOLE SIZE, LOCATION

[TOP VIEW]

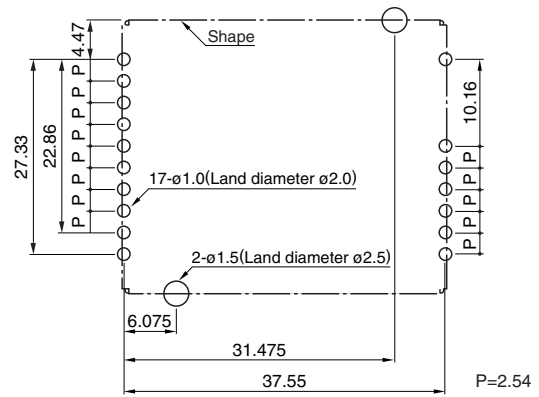

Dimensions in mm
Tolerance: ±0.5

CC15-xxxxSR-E (SMD TYPE)

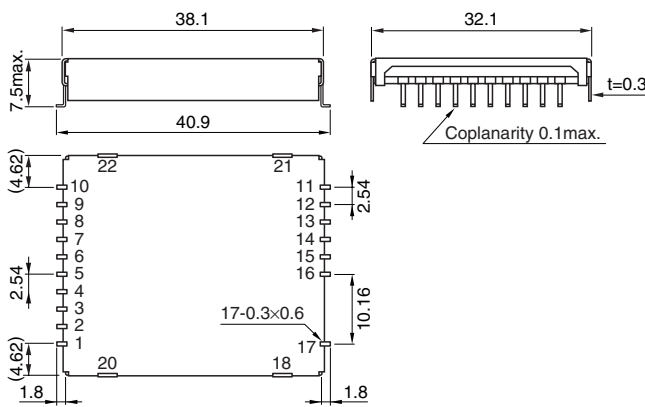

RECOMMENDED PWB HOLE SIZE, LOCATION

[TOP VIEW]

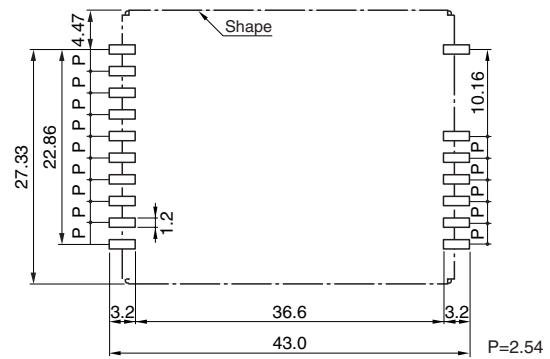

Dimensions in mm
Tolerance: ±0.5

CONNECTION

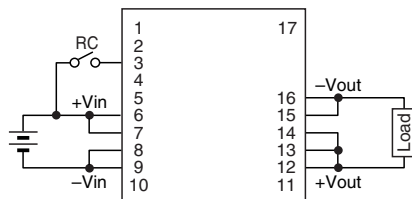

TERMINAL PIN CONFIGURATION

No.1	NC	No.10	NC
No.2	NC	No.11	NC
No.3	RC	No.12	+Vout
No.4	NC	No.13	+Vout
No.5	NC	No.14	+Vout
No.6	+Vin	No.15	-Vout
No.7	+Vin	No.16	-Vout
No.8	-Vin	No.17	NC
No.9	-Vin		

CC25 Type

ELECTRICAL CHARACTERISTICS

Part No.	Input voltage (V)	Output voltage*2 (V)	Output current (mA)	Voltage stability			Output ripple noise voltage*3 (mVp-p) typ./max.	Efficiency*4 (%)	Input-output insulation
				Input (mV)max.	Load (mV)max.	Temperature (mV)max.			
CC25-2403Sx*1-E	18 to 36	3.3/-3 to +5%	0 to 7500	40	120	80	40/120	90	Withstand voltage AC.500V 1min Resistance DC.500V 50MΩ min.
CC25-2405Sx-E	18 to 36	5.0/-3 to +5%	0 to 5000	50	200	80	40/120	90	

*1 An "x" within the product name is to be replaced by the symbol representing the terminal structure (F: DIP / R: SMD).

*2 Total output voltage is including input, load, and temperature regulation.

*3 Measurement bandwidth: 50MHz

*4 Typical input voltage, maximum output current

OUTPUT POWER - AMBIENT TEMPERATURE(DERATING)

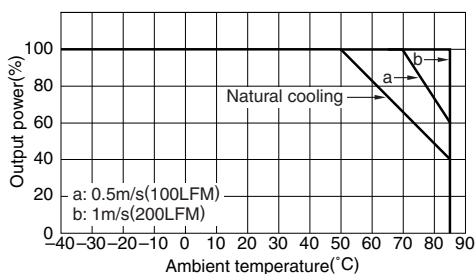

COMMON SPECIFICATIONS

Overcurrent protection	Output current limitation system, Output voltage shut-down type
Operating temperature range	-40 to +85°C[Derating is necessary when operating environment temperature exceed 50°C]
Storage temperature range	-40 to +85°C
Humidity range	95(%)RH max. [Maximum wet-bulb temperature: 38°C]
Amplitude	10 to 55Hz, all amplitude 1.52mm, sweep time 15min[3 directions of X, Y, Z, each 2h]
Vibration	500m/s ² (51G) 6ms[6 directions, each 3 times]
Withstand voltage Eac	Input to output, input to case, output to case: 500V, 1min
Insulation resistance	Input to output, input to case, output to case: 50MΩ min.[DC.500V]
Safety standards	UL60950-1, C-UL(CSA22.2 No.60950-1), EN60950-1 certified
Weight	20.0g

CC25 Type

SHAPES AND DIMENSIONS

CC25-xxxxSF-E (DIP TYPE)

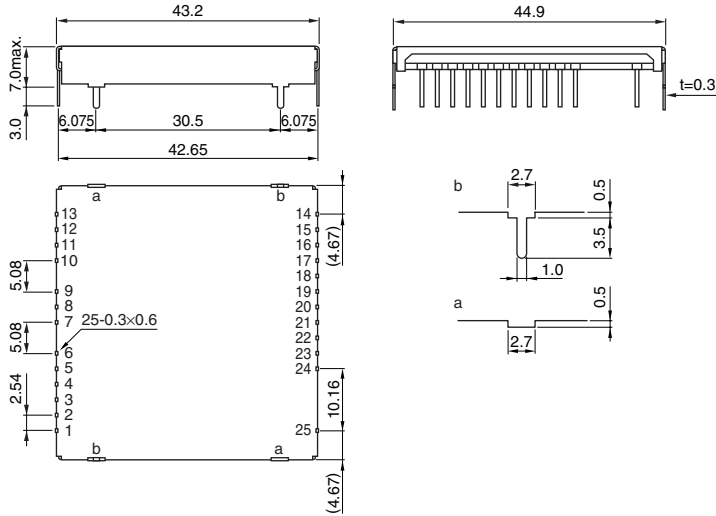

RECOMMENDED PWB HOLE SIZE, LOCATION [TOP VIEW]

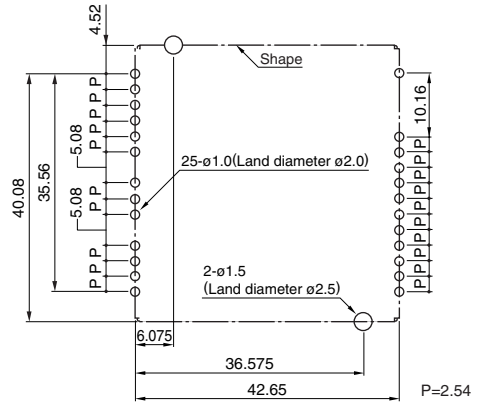

Dimensions in mm
Tolerance: ±0.5

CC25-xxxxSR-E (SMD TYPE)

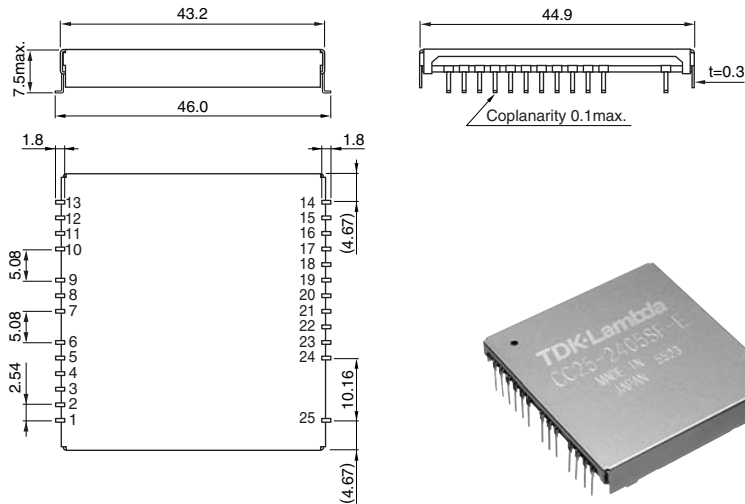

RECOMMENDED PWB HOLE SIZE, LOCATION [TOP VIEW]

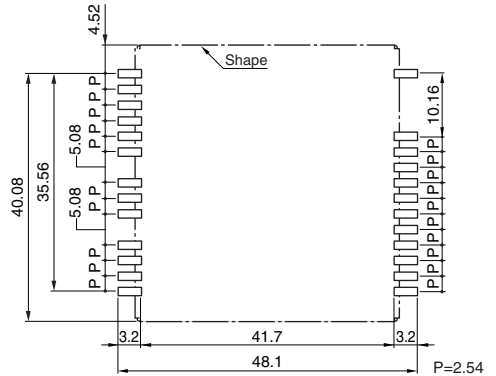

Dimensions in mm
Tolerance: ±0.5

CONNECTION

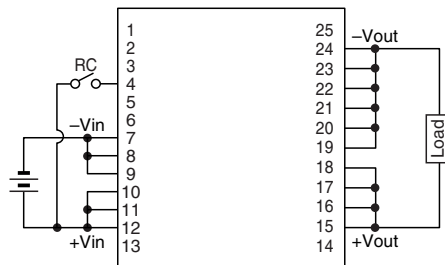

TERMINAL PIN CONFIGURATION

No.1 NC	No.10 +Vin	No.19 -Vout
No.2 NC	No.11 +Vin	No.20 -Vout
No.3 NC	No.12 +Vin	No.21 -Vout
No.4 RC	No.13 NC	No.22 -Vout
No.5 NC	No.14 NC	No.23 -Vout
No.6 NC	No.15 +Vout	No.24 -Vout
No.7 -Vin	No.16 +Vout	No.25 NC
No.8 -Vin	No.17 +Vout	
No.9 -Vin	No.18 +Vout	

• All specifications are subject to change without notice.

Control Functions/Connections

REMOTE CONTROL TERMINAL(RC) (DIP/SMD MODELS)

1.5 to 10W Types

It is recommended to use an open collector as the control method for the remote control terminal. If other methods are necessary, please contact TDK first.

In addition, please use a transistor with V_{CE} : Over V_{in} and I_c : Over 1mA.

When the RC terminal is open, the output is OFF, and when the RC terminal and $-V_{in}$ are shorted (0 to 0.4V) the output is ON.

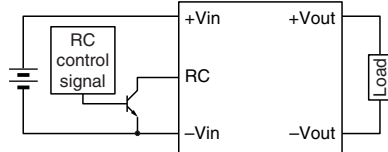

If not using this function (always ON), short-circuit the RC terminal and the $-V_{in}$ terminal.

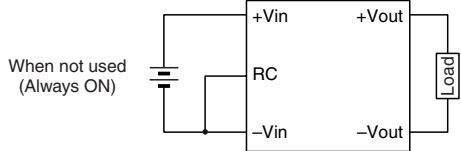

15 and 25W Types

When the RC terminal is open, the output is ON, and when the RC terminal is HIGH (connected to $+V_{in}$) the output is OFF.

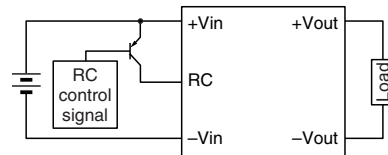

If not using this function (always ON), short-circuit the RC terminal and the $-V_{in}$ terminal.

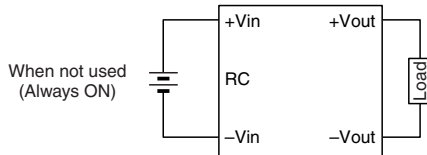

OUTPUT VARIABLE TERMINAL(TRM) (1.5 to 10W Types)

The output voltage can be set to the value shown in the following table by connecting the TRM terminal with the $-V_{out}$ terminal. Please open the TRM terminal when not using this function.

Please take note that it is necessary to derate the output current to match the maximum power when the output voltage is set higher by this function.

DIP/SMD Models

Part No.	Open	Connected with $-V_{out}$	Fig.
CCx-xx03Sx	3.3V	3.6V	1
CCx-xx05Sx	5.0V	6.0V	1
CCx-xx12Sx	12V	15V	1
CCx-xx12Dx	$\pm 12V$	$\pm 15V$	2

* To be replaced by 1R5(1.5W), 3(3W), 6(6W) and 10(10W).

Fig.1

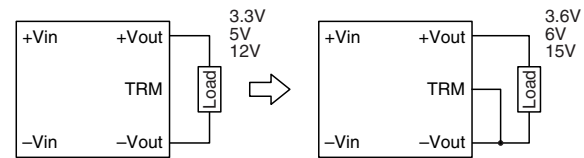
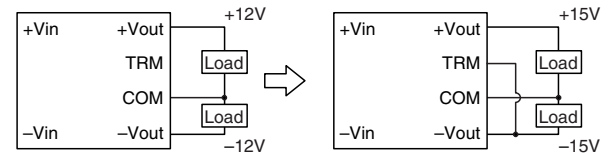

Fig.2



SIP Model

Part No.	Open	Connected with $-V_{out}$	Fig.
CC3-xx03SS-E	3.3V	3.67V	3
CC3-xx05SS-E	5V	6V	3
CC3-xx12SS-E	12V	15V	3
CC3-xx12DS-E	$\pm 12V$	$\pm 15V$	4

Fig.3

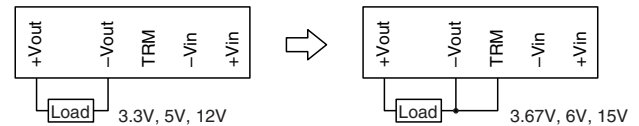
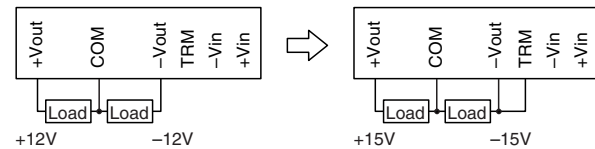

Fig.4



Control Functions/Connections

With the ±12V, 24V single output is possible by opening the COM terminal and TRM terminal. Also, 30V single output is possible when opening the COM terminal and connecting the TRM terminal with the -Vout terminal.

DIP/SMD Models

Part No.	COM terminal	TRM terminal	Single output	Fig.
CCx*-xx12Dx-E	Open	Open	24V	5
	Open	Connected with -Vout	30V	6

* To be replaced by 1R5(1.5W), 3(3W), 6(6W) and 10(10W).

Fig.5

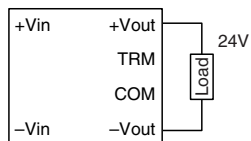
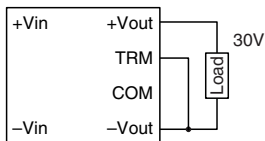

Fig.6



SIP Model

Part No.	COM terminal	TRM terminal	Single output	Fig.
CC3-xx12DS-E	Open	Open	24V	7
	Open	Connected with -Vout	30V	8

Fig.7

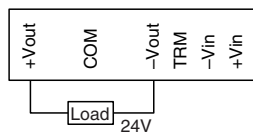
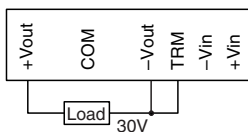

Fig.8



OUTPUT VARIABILITY FUNCTION (ADDING EXTERNAL RESISTANCE) (1.5 to 10W Types)

The output voltage can be adjusted within the range shown in the following table by connecting resistance (Ra, Rb) between the TRM terminal and the -Vout terminal, or between the TRM terminal and the +Vout terminal.

Please take note that it is necessary to derate the output current to match the maximum power when the output voltage is setted higher.

DIP/SMD Models

Part No.	Connecting -Vout with Ra	Fig.	Connecting +Vout with Rb	Fig.
CCx*-xx03Sx-E	3.3 to 3.6V*1	9	3.15 to 3.3V*5	10
CCx-xx05Sx-E	5 to 6V*2	9	4.75 to 5V*6	10
CCx-xx12Sx-E	12 to 15V*3	9	11.4 to 12V*7	10
CCx-xx12Dx-E	±12 to ±15V*4	11	±11.4 to ±12V*8	12

* To be replaced by 1R5(1.5W), 3(3W), 6(6W) and 10(10W).

Calculate the output voltage Vout(V) from the connected resistance Ra, Rb(kΩ)

Set the output voltage higher by adding resistance Ra between the TRM terminal/-Vout terminal.

- *1 $V_{out} = 3.3 + 9.59 / (32 + R_a)$
- *2 $V_{out} = 5.01 + 17.64 / (17.8 + R_a)$
- *3 $V_{out} = 12.01 + 50.53 / (16.9 + R_a)$
- *4 $V_{out} = 12.02 + 53.55 / (18 + R_a)$

Set the output voltage lower by adding resistance Rb between the TRM terminal/+Vout terminal.

- *5 $V_{out} = 3.3 - 15.53 / (39.6 + R_b)$ [$R_b \geq 62$]
- *6 $V_{out} = 5.01 - 52.55 / (31.8 + R_b)$ [$R_b \geq 160$]
- *7 $V_{out} = 12.01 - 431.1 / (57 + R_b)$ [$R_b \geq 620$]
- *8 $V_{out} = 12.02 - 968.5 / (103 + R_b)$ [$R_b \geq 1500$]

Calculate the connected resistance Ra and Rb(kΩ) from the set output voltage Vout(V).

Set the output voltage higher by adding resistance Ra between the TRM terminal/-Vout terminal.

- *1 $R_a = 9.59 / (V_{out} - 3.3) - 32$
- *2 $R_a = 17.64 / (V_{out} - 5.01) - 17.8$
- *3 $R_a = 50.53 / (V_{out} - 12.01) - 16.9$
- *4 $R_a = 53.55 / (V_{out} - 12.02) - 18$

Set the output voltage lower by adding resistance Rb between the TRM terminal/+Vout terminal.

- *5 $R_b = 15.53 / (3.3 - V_{out}) - 39.6$
- *6 $R_b = 52.55 / (5.01 - V_{out}) - 31.8$
- *7 $R_b = 431.1 / (12.01 - V_{out}) - 57$
- *8 $R_b = 968.5 / (12.02 - V_{out}) - 103$

Fig.9

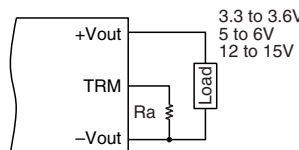

Fig.10

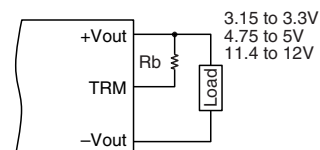

Fig.11

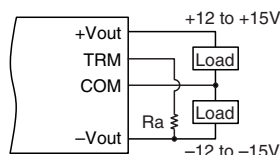
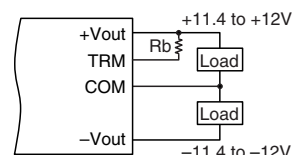

Fig.12



• All specifications are subject to change without notice.

Control Functions/Connections

SIP Model

Part No.	Connecting -Vout with Ra	Fig.	Connecting +Vout with Rb	Fig.
CC3-xx03SS-E	3.3 to 3.67V ^{*1}	13	3.15 to 3.3V ^{*5}	14
CC3-xx05SS-E	5 to 6V ^{*2}	13	4.75 to 5V ^{*6}	14
CC3-xx12SS-E	12 to 15V ^{*3}	13	11.4 to 12V ^{*7}	14
CC3-xx12DS-E	±12 to ±15V ^{*4}	15	±11.4 to ±12V ^{*8}	16

Calculate the output voltage Vout(V) from the connected resistance Ra, Rb(kΩ)

Set the output voltage higher by adding resistance Ra between the TRM terminal/-Vout terminal.

$$*1 \text{ Vout} = 3.3 + 1.04 / (2.83 + R_a)$$

$$*2 \text{ Vout} = 5 + 12.75 / (12.69 + R_a)$$

$$*3 \text{ Vout} = 12 + 48.4 / (16.18 + R_a)$$

$$*4 \text{ Vout} = 12 + 54.7 / (18 + R_a)$$

Set the output voltage lower by adding resistance Rb between the TRM terminal/+Vout terminal.

$$*5 \text{ Vout} = 3.3 - 1.69 / (3.66 + R_b) \quad [R_b \geq 7.6]$$

$$*6 \text{ Vout} = 5 - 12.78 / (17.79 + R_b) \quad [R_b \geq 33.3]$$

$$*7 \text{ Vout} = 12 - 184.1 / (35.54 + R_b) \quad [R_b \geq 271.3]$$

$$*8 \text{ Vout} = 12 - 470.3 / (61.75 + R_b) \quad [R_b \geq 722.1]$$

Calculate the connected resistance Ra and Rb(kΩ) from the set output voltage Vout(V).

Set the output voltage higher by adding resistance Ra between the TRM terminal/-Vout terminal.

$$*1 \text{ Ra} = 1.04 / (\text{Vout} - 3.3) - 2.83$$

$$*2 \text{ Ra} = 12.75 / (\text{Vout} - 5) - 12.69$$

$$*3 \text{ Ra} = 48.4 / (\text{Vout} - 12) - 16.18$$

$$*4 \text{ Ra} = 54.7 / (\text{Vout} - 12) - 18$$

Set the output voltage lower by adding resistance Rb between the TRM terminal/+Vout terminal.

$$*5 \text{ Rb} = 1.69 / (3.3 - \text{Vout}) - 3.66$$

$$*6 \text{ Rb} = 12.78 / (5 - \text{Vout}) - 17.79$$

$$*7 \text{ Rb} = 184.1 / (12 - \text{Vout}) - 35.54$$

$$*8 \text{ Rb} = 470.3 / (12 - \text{Vout}) - 61.75$$

Fig.13

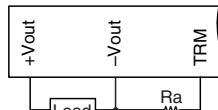

3.3 to 3.67V, 5 to 6V, 12 to 15V

Fig.14

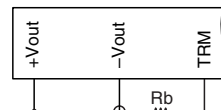

3.15 to 3.3V, 4.75 to 5V, 11.4 to 12V

Fig.15

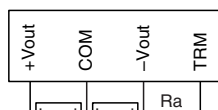

+12 to +15V -12 to -15V

Fig.16

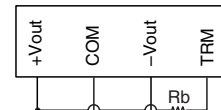

+11.4 to +12V -11.4 to -12V

Noise Reduction Measurement

REDUCING RIPPLE NOISE

If ripple noise from the converter is not measured, the results may differ greatly depending on the measurement method. Therefore, when measuring ripple noise, be sure to measure the noise from the root part of the output terminal and not to make a loop so that magnetic flux is not collected when connecting the probe. Please keep in mind that spike voltage may vary greatly depending on the ripple voltmeter and the frequency range of the oscilloscope. TDK measures noise using the following wiring at a frequency range of 50MHz.

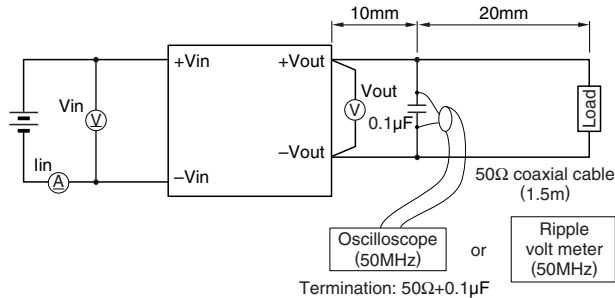

INPUT RIPPLE NOISE

This series contains a capacitor at the input location. Therefore, it is possible to be operated without connecting an external capacitor for the input. However, if a capacitor is connected, it is possible to reduce input ripple noise and input return noise. Input ripple noise can be reduced even further when a π type filter is used as shown in the following diagram.

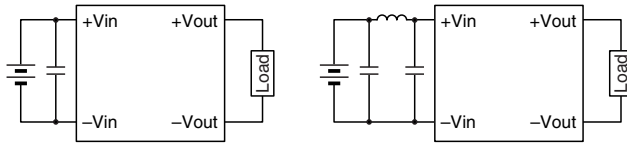

When the distance between the input power source and the input location of the converter is great, install a capacitor near an input terminal as much as possible.

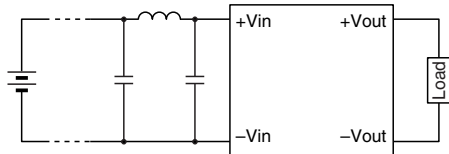

When the distance between the input power source and the input location of the converter is great, the impedance of the input line becomes high and spike noise may also increase.

Therefore, in such cases, it is recommended to connect the capacitor as close to the input location of the DC to DC converter as possible.

OUTPUT RIPPLE NOISE

In order to reduce output ripple noise, connect the capacitor to the output portion of the converter. Output ripple noise can be reduced even further when a π type filter is used as shown in the following diagram. If such a filter is used, please use a coil upto 100µH.

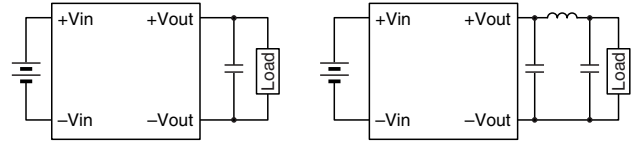

When the distance between the converter output and the load is great, connect the capacitor to the root portion of the load. To reduce output spike noise, connect a ceramic capacitor with 0 to 1µF to the output portion of the converter.

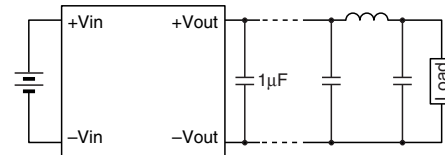

OUTPUT EXTERNAL CAPACITANCE RANGES

Please keep in mind that if the capacitor installed at the output location has a larger capacity than shown in the following value, or if capacitors with low impedance are connected parallel much, converter operation may be unstable.

Part No.	Capacitance(µF)max.
CC1R5-xx03Sx-E	100
CC1R5-xx05Sx-E	100
CC1R5-xx12Sx-E	47
CC1R5-xx12Dx-E	22
CC3-xx03Sx-E	220
CC3-xx05Sx-E	220
CC3-xx12Sx-E	100
CC3-xx12Dx-E	47
CC6-xx03Sx-E	470
CC6-xx05Sx-E	470
CC6-xx12Sx-E	220
CC6-xx12Dx-E	100
CC10-xx03Sx-E	470
CC10-xx05Sx-E	470
CC10-xx12Sx-E	220
CC10-xx12Dx-E	100
CC15-24xxSx-E	470
CC25-24xxSx-E	470

Noise Reduction Measurement/Protection/Connections

COMMON MODE NOISE

Products with under 10W contain capacitors that are not connected between the first and second. Therefore, in order to reduce common mode noise, please connect a capacitor with about 1,000pF between the first and second GND as shown in the following diagram.

Also, please keep in mind that if the connected capacitor is too large, the coupling capacitance between the input and output will become too high.

Be sure to also keep in mind the capacitor's withstand voltage (over 500V is recommended based on insulation withstand voltage).

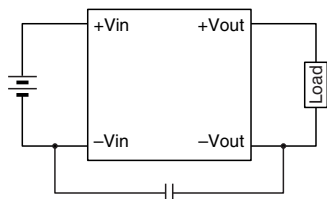

10W-product contains capacitors with 1,000pF connected between the first and second.

RADIATION NOISE

It is possible to reduce the converter's radiation noise by connecting a case terminal(SMD model has not a case terminal.) to the input or output GND. However, efficiency will be different depending on the equipment being used.

Therefore, confirm this by using your actual equipment.

In addition, please wire the bottom of the converter to the GND line and wire using a wide surface.

OVERCURRENT PROTECTION

1.5 to 10W Types

This series is equipped with an overcurrent protection circuit. This means that when the output current begins to flow over the starting point of the overcurrent, the output voltage becomes lower.

The output voltage is recovered automatically by releasing the overcurrent and short circulation status.

However, please keep in mind that if the overcurrent status continues for over 30 seconds, internal elements of the converter will deteriorate or be damaged.

The start point of the overcurrent is never lower than the rated current.

If auto recovery is not executed when the overcurrent status is released for some reason, please restart it after turning the electrical power or the remote OFF one time.

15 to 25W Types

This series is recovery with an overcurrent protection circuit.

This means that when the output current begins to flow over the rated current, the output voltage falls, and a converter steps a latch.

If the overcurrent and the short circuit are released, the output voltage can not be recovered automatically.

Please restart the power source to recover the output voltage.

The start point of the overcurrent is never lower than the rated current.

OVERVOLTAGE PROTECTION

This series is not equipped with an overvoltage protection function. Please keep in mind that if overvoltage is impressed externally over the rated voltage, it may cause damage.

LOW INPUT VOLTAGE PROTECTION

This series is equipped with low voltage input protection in order to prevent errors caused by low input voltage. This means that the converter stops operating when the voltage is below the specified voltage. The following chart shows the specified range.

Part No.	Input voltage range	Specified voltage range for protection circuit
CCx*-05xxxx-E	4.5 to 9V	3 to 4.5V
CCx-12xxxx-E	9 to 18V	6 to 9V
CCx-24xxxx-E	18 to 36V	13 to 18V
CCx-48xxxx-E	36 to 76V	27 to 36V
CC15-24xxSx-E	18 to 36V	12 to 18V
CC25-24xxSx-E	18 to 36V	12 to 18V

* To be replaced by 1R5(1.5W), 3(3W), 6(6W) and 10(10W).

WITHSTAND VOLTAGE

The withstand voltage between the input and output, and between the terminal and the casing is AC.500V.

SERIES AND PARALLEL CONNECTIONS

SERIES CONNECTION

It is possible to have a series connection by using the wiring shown in the following diagram on the left. However, if the output voltage does not begin with this connection, connect the schottky barrier diode, which has low forward voltage, as shown in the following diagram on the right. In this case, be sure to use a schottky barrier diode that has a forward current larger than the converter's rated current and that has a reverse withstand voltage at least two times larger than the voltage between the +Vout and -Vout.

Also, make sure that the output current is below the rated current of the smaller converter.

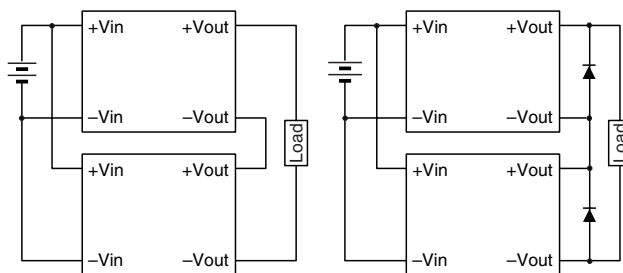

PARALLEL CONNECTION

It is not possible to have a parallel connection for increasing currents.

Soldering Conditions/Cleaning Conditions

SOLDERING CONDITIONS

DIP and SIP Models

Make sure to perform soldering to the PC board under the following conditions.

Soldering DIP	260°C, for 10 seconds max.
Soldering iron	380°C, for 3 seconds max.

SMD Model

Lead-free solder/high-temperature reflow process

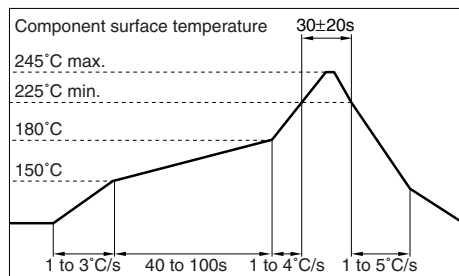

CLEANING CONDITIONS

It is recommended that the PC board should not be cleaned after soldering. It, however, has already been checked that there is no problem as a result of the following cleaning agents and test conditions.

When cleaning with one of the following cleaning agents, it should be used under these conditions. When using cleaning agent other than the following, please consult TDK before use.

Cleaning Agents and Test Conditions

Clean Through 750H

- (1) Cleaning (Agitation) 60°C/4min
- (2) Rinsing (Agitation, water) 60°C/4min
- (3) Rinsing (Agitation, water) Room temperature to 40°C/4min
- (4) Drying 70°C/6min

Pine Alpha ST100S

- (1) Cleaning (Agitation) 60°C/5min
- (2) Rinsing (Agitation, water) 30°C/10min
- (3) Drying 70°C/6min

Terpene Cleaner EC-7R

- (1) Cleaning (Agitation) 60°C/5min
- (2) Rinsing (Agitation, IPA) 30°C/10min
- (3) Drying 70°C/6min

Isopropyl Alcohol

- (1) Ultrasonic cleaning 60°C/1min
- (2) Cooling bath cleaning R.T./1min
- (3) Vapor cleaning 83°C/1min

Asahi Clean AK225AES

- (1) Ultrasonic cleaning 50°C/2min
- (2) Cooling bath cleaning R.T./2min