

**STK4067**

## High-Output Power Amplifier for Car Stereos (Po = 60 W typ.)

### Overview

Higher output amplification of the car stereo has been generally dependent on boosting voltage of the power supply. The STK4067 supports low-load impedance and is designed for up to 60 W of high output without the need for a power supply voltage booster circuit.

### Applications

- Power amplifier for car stereos
- Home karaoke systems
- Radio-cassette players

### Features

- Superior heat sink capacity using IMST (insulated metal substrate technology)
- Designed for high output while supporting low-load impedance
  - ①  $R_L = 1\Omega$  60 W typ. (EIAJ) 100 W (max.)
  - ②  $R_L = 2\Omega$  40 W typ. (EIAJ) 70 W (max.)
  - ③  $R_L = 4\Omega$  23 W typ. (EIAJ) 40 W (max.)
- Supports sufficient amplifier configurations for high power output
- Low-load impedance driver
  - Supports independent or parallel speaker connections for low-load impedance driving.
- Low distortion
  - THD = 0.025% typ. ( $V_{CC} = 13.2\text{ V}$ ,  $R_L = 2\Omega$ ,  $P_o = 10\text{ W}$ ,  $f = 1\text{ kHz}$ )
  - Compared with a monolithic IC, with a base frequency of 100 Hz, the following is established: secondary high frequency harmonics switches to -58 dB, with third-order switching to -20 dB, fourth-order to -45 dB, and fifth-order to -18 dB.
- High temperature operation
  - Provides guaranteed high output to the passenger compartments protected interior even when operating in excessive heat
- Compact heat sink mounting
  - Supports compact total-set packaging, occupying 1/3 the heat sink area compared of monolithic ICs, and equipped with an 85°C temperature range and 110°C guaranteed case temperature rating

- Low operating power supply voltage range (9 V to 16 V)
- Built-in muting circuit
  - Short attack time with muting quickly enabled
- Built-in protection circuits
  - Built-in thermal shutdown and overvoltage protector

### Package Dimensions

unit : mm

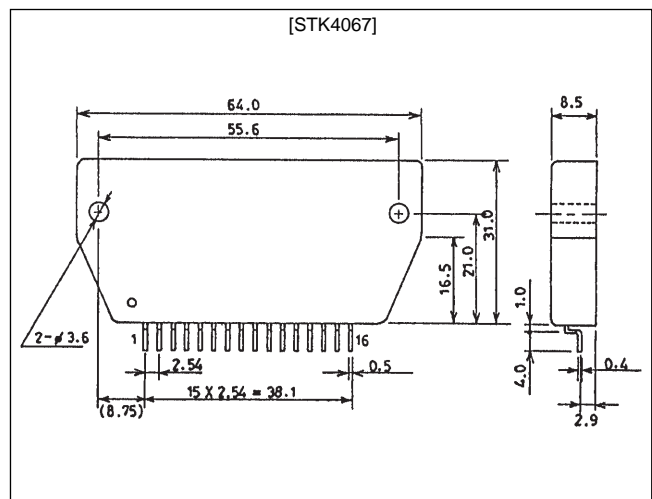
**4131**

## Specifications

### Maximum Ratings at Ta=25°C

Parameter	Symbol	Conditions	Ratings	Unit
Maximum supply voltage	V <sub>CC</sub> max (1)	No signal (with circuit cut off) 30s	30	V
	V <sub>CC</sub> max (2)	With signal (f = 100 kHz, V <sub>in</sub> = 1 Vrms, t = 100 ms)	18	V
Output current	I <sub>O</sub> max		15	A
Junction temperature	T <sub>j</sub>		150	°C
Thermal resistance	θ <sub>j-c</sub>	Per power transistor	1.6	°C/W
Operating substrate temperature	T <sub>c</sub>		110	°C
Storage temperature	T <sub>stg</sub>		-40 to +125	°C
Available time for load shorted	ts	V <sub>CC</sub> = 13.2 V, R <sub>L</sub> = 2 Ω, f = 50 Hz, P <sub>O</sub> = 25 W	2	s

### Recommended Operating Conditions at Ta=25°C

Parameter	Symbol	Conditions	Ratings	Unit
Recommended supply voltage	V <sub>CC</sub>		13.2	V
Load resistance	R <sub>L</sub>		2	Ω

### Operating Characteristics at Ta = 25°C, V<sub>CC</sub> = 13.2 V, R<sub>L</sub> = 2 Ω, R<sub>g</sub> = 600 Ω, VG = 46 dB

Parameter	Symbol	Conditions	min	typ	max	Unit
Quiescent current	I <sub>CCO</sub>	R <sub>g</sub> = 10 kΩ		70	140	mA
Output power	P <sub>O</sub> (1)	THD = 10%, f = 1 kHz, R <sub>L</sub> = 1 Ω	50	60		W
	P <sub>O</sub> (2)	THD = 10%, f = 1 kHz, R <sub>L</sub> = 2 Ω		40		W
Total harmonic distortion	THD (1)	P <sub>O</sub> = 10 W, f = 1kHz		0.025	0.1	%
	THD (2)	P <sub>O</sub> = 1 W, f = 20 to 20 kHz			0.4	%
Voltage gain	VG	P <sub>O</sub> = 1 W, f = 1 kHz	43.8	46.0	48.2	dB
Frequency response	f <sub>L</sub> , f <sub>H</sub>	P <sub>O</sub> = 1 W, +0 -3 dB		20 to 30k		Hz
Input resistance	r <sub>i</sub>	P <sub>O</sub> = 1 W, f = 1 kHz	20	30		kΩ
Output noise voltage	V <sub>NO</sub>	R <sub>g</sub> = 10 kΩ, BPF		0.6	1.2	mVrms
Output offset voltage	ΔVN	R <sub>g</sub> = 10 kΩ	-200	0	+200	mV
Muting suppression level	ATT	V <sub>M</sub> = +5 V		∞		dB
Ripple rejection	SVRR	f <sub>R</sub> = 100 Hz, R <sub>g</sub> = 0 Ω, V <sub>R</sub> = 0 dBm		-47		dB

### Equivalent Circuit

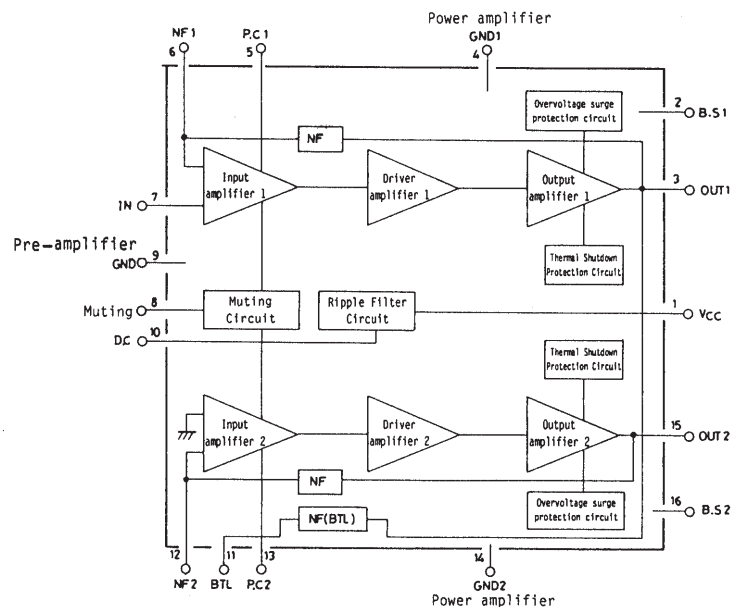

## STK4067 Design Data

## (1) The Protection Circuits

## a) Overvoltage Protector

Since the STK4067 is designed for car stereo applications,  $V_{CC}$  max for operating mode is set to 18 V. Exceeding the  $V_{CC}$  maximum level activates the overvoltage protector and the circuit switches to an off-state and delivers no output. The overvoltage protection circuit is set for a functional range from 18 to 28 V; 100% operation at 28 V. For this reason, you should be careful not to exceed the 18 V limit in quiescent mode and keep in mind AC line regulations when setting using a transformer power supply for designs such as home stereo systems. Exceeding 18 V activates the overvoltage protector and results in the generation of abnormal sounds.

## b) Thermal Shutdown

The thermal shutdown protection circuit is designed to first detect abnormal temperature rises which occur during abnormal operation (such as load shorts) and then prevent damage to the IC by limiting the input signal; thereby preventing a further rise in the temperature. The thermal shutdown protector is set to activate at substrate temperature of 135°C with a complete shutdown by switching to an off-state if temperatures rise to 175°C. Under normal application, the IC is equipped with a heat sink and the temperature never reaches a level resulting in a complete off-state switch and saturation occurs at a specific temperature. For example, when a short occurs with an IC mounted 4.5°C/W heat sink, saturation is achieved at approximately 160°C. At this point,  $T_j$  exceeds its maximum rating of 170°C. As previously mentioned, this circuit is designed to protect the IC from damage sustained in a short period of time and you should note that the protection circuit will not protect the IC if abnormal temperature rises occur over a long period of time.

## (2) Precautions

## a) Excessive Input

If a 1 V or greater ( $f = 1$  kHz.rms) overinput is applied to the input pin, the DC balance of the input channel for the input monolithic amplifier is disrupted and output is cut off. In addition, DC voltage is generated on the output pins and causes damage to the speakers. Proper caution should be displayed in preventing input above this voltage.

## b) Parasitic Oscillation

The STK4067 performs phase compensation using 2.2Ω and 0.47μF between  $V_{CC}$  and the bootstrap pins. Under such conditions, the power supply line must be in a close proximity to the bootstrap pins for the inverting and non-inverting amplifiers. If the power line is too long, parasitic oscillation is likely to occur at low temperatures. If such a problem arises, add a 0.1μF rated condenser between the ground and the head of the power supply line in order to lower the impedance.

## c) Power Supply Voltage Inverse Application

The STK4067 is not equipped with a built-in power supply voltage inversion protection circuit. If the possibility exists, one should be externally connected.

## d) Power Off

Do not connect pin 1 of the  $V_{CC}$  pin directly to the ground or else the IC will be damaged. When connecting pin 1, install a resistor rated for 100Ω or greater in series with pin 1, or you may place a diode between pin 10 and pin 1.

## (3) Application Circuits

a) The under frequency band may be magnified, for applications using a booster amplifier or woofer driver amplifier, the bootstrap condensers (C3 and C4) can be changed from 220μF to 470μF. Refer to  $P_O$ -f graphs.

b)  $L1 = 3$  μH and  $R3 = 4.7$ Ω are for anti-oscillation applications against capacity loads. We recommend the use of this coil and resistor with the most compatible amplifier sets connected to general use speakers. This coil is not necessary when the load capacity is low using a chosen speaker connected to a radio-cassette player or active speaker.

# STK4067

## Example PCB

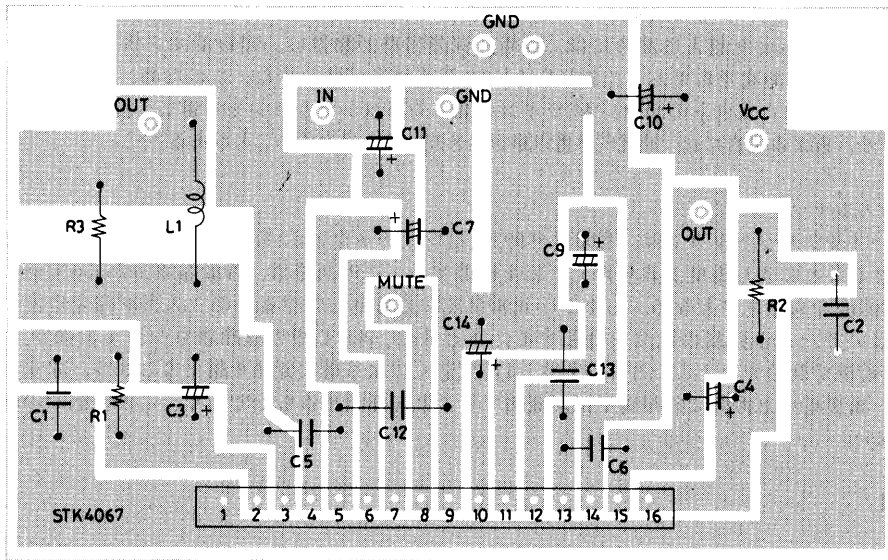

Bottom view

## Sample Application Circuit

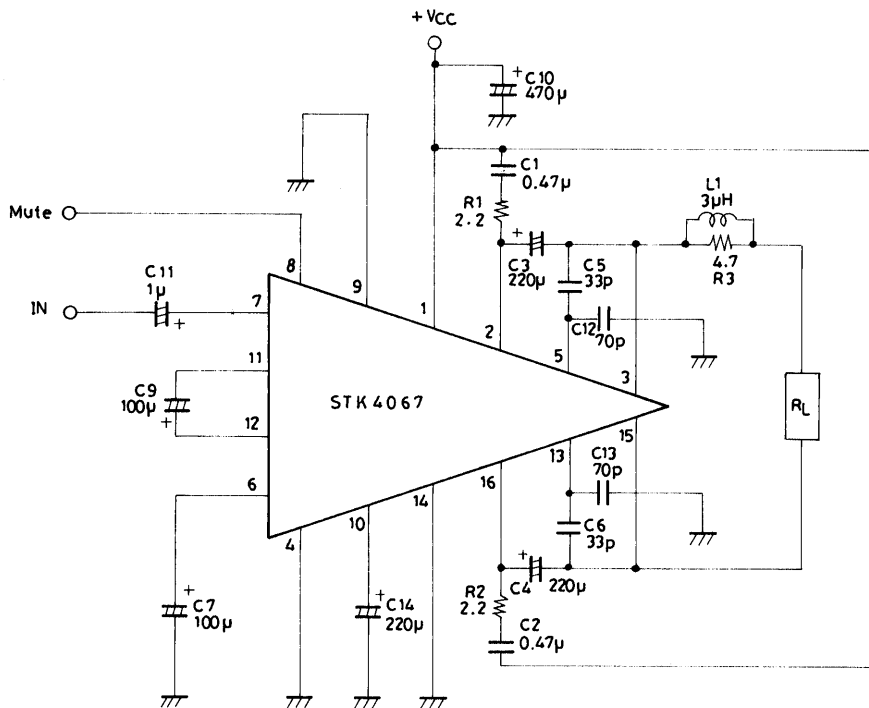

Unit (resistance: Ω, capacitance: F)

**Sample STK4067 Heat Sink Design**

The radiator thermal resistance  $\theta_{c-a}$  required for total substrate power dissipation  $P_d$  in the STK4067 is determined as:

Condition 1: IC substrate temperature  $T_c$  not to exceed  $110^\circ\text{C}$ .

$$P_d \times \theta_{c-a} + T_a < 110^\circ\text{C} \dots\dots\dots (1)$$

where  $T_a$  is set assured ambient temperature.

Condition 2: Power transistor junction temperature  $T_j$  not to exceed  $150^\circ\text{C}$ .

$$P_d \times \theta_{c-a} + P_d/N \times \theta_{j-c} + T_a < 150^\circ\text{C} \dots\dots\dots (2)$$

where  $N$  is the number of power transistors and  $\theta_{j-c}$  is the thermal resistance per power transistor chip. However, power transistor power consumption is  $P_d$  equally divided by  $N$  units.

Expressions (1) and (2) can be rewritten based on  $\theta_{c-a}$  to yield:

$$\theta_{c-a} < (110 - T_a) / P_d \dots\dots\dots (1')$$

$$\theta_{c-a} < (150 - T_a) / P_d - \theta_{j-c} / N \dots\dots\dots (2')$$

The required radiator thermal resistance will satisfy both of these expressions.

From expressions (1)' and (2)', the required radiator thermal resistance can be determined once the following specifications are known:

- Supply voltage  $V_{CC}$
- Load resistance  $R_L$
- Assured ambient temperature  $T_a$

The total substrate power consumption when STK4067  $V_{CC}$  is  $\pm 13.2\text{ V}$  and  $R_L$  is  $2\ \Omega$ , for a continuous sine wave signal, is a maximum of  $19.3\text{ W}$  (Fig. 2).

The STK4067 has four power transistors, so the thermal resistance per transistor  $\theta_{j-c}$  is  $1.6^\circ\text{C} / \text{W}$ . With an assured ambient temperature  $T_a$  of  $50^\circ\text{C}$ , the required radiator thermal resistance  $\theta_{c-a}$  would be:

$$\begin{aligned} \text{From expression (1)' } \theta_{c-a} &< (110 - 50) / 19.3 \\ &< 3.1 \\ \text{From expression (2)' } \theta_{c-a} &< (150 - 50) / 19.3 - 1.6 / 4 \\ &< 4.78 \end{aligned}$$

To satisfy both,  $3.1^\circ\text{C/W}$  is the required radiator thermal resistance.

Figure 1 illustrates  $P_d - P_O$  when the  $V_{CC}$  of STK4067 is  $13.2\text{ V}$  and  $R_L$  is functioning at  $1\ \Omega$ .

$$\begin{aligned} P_d \text{ max} &= 34.8\text{ W} \\ \text{From expression (1)' } \theta_{c-a} &< (110 - 50) / 34.8 \\ &< 1.72 \\ \text{From expression (2)' } \theta_{c-a} &< (150 - 50) / 34.8 - 1.6 / 4 \\ &< 2.47 \end{aligned}$$

To satisfy both,  $1.72^\circ\text{C/W}$  is the required radiator thermal resistance.

Similar to figure 3 when the STK4067's  $V_{CC}$  is  $13.2\text{ V}$  and  $R_L$  is  $4\ \Omega$ .

$$\begin{aligned} P_d \text{ max} &= 12\text{ W} \\ \text{From expression (1)' } \theta_{c-a} &< (110 - 50) / 12 \\ &< 5 \\ \text{From expression (2)' } \theta_{c-a} &< (150 - 50) / 12 - 1.6 / 4 \\ &< 7.93 \end{aligned}$$

To satisfy both,  $5^\circ\text{C} / \text{W}$  is the required radiator thermal resistance. This design example is based on a fixed voltage supply, and will require verification within your specific set environment.

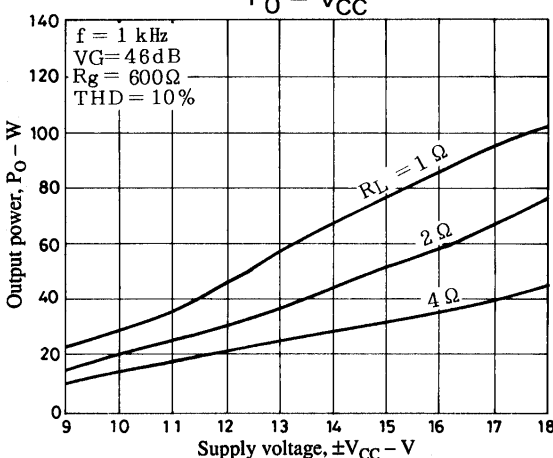
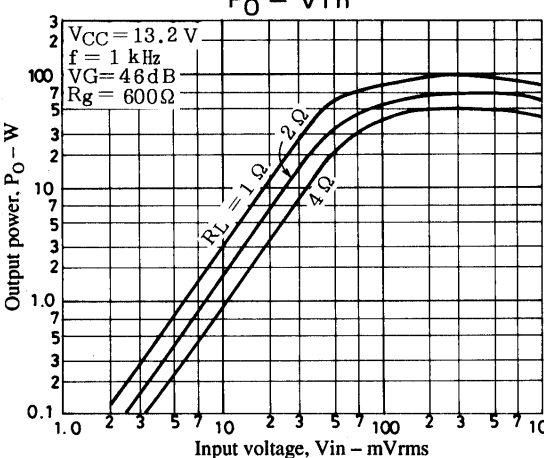
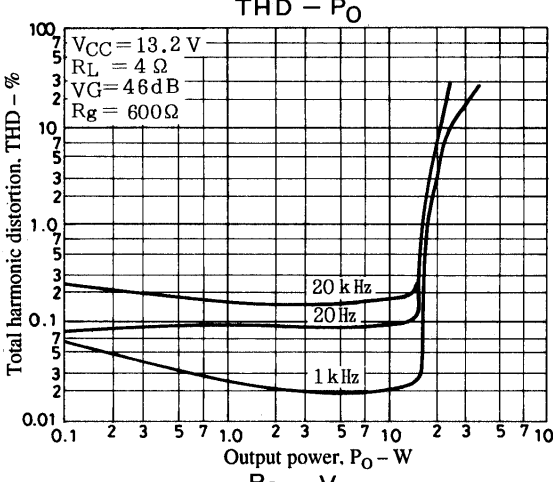
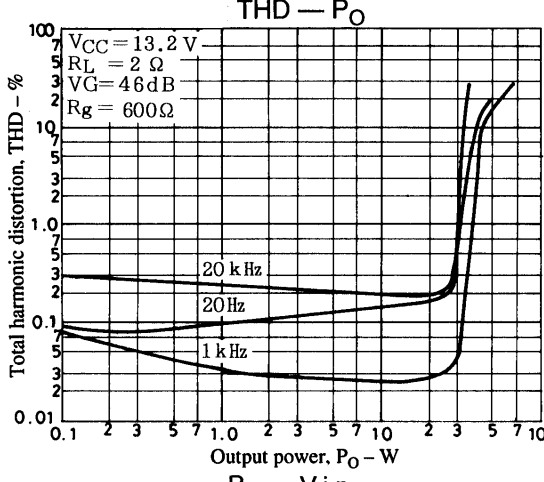
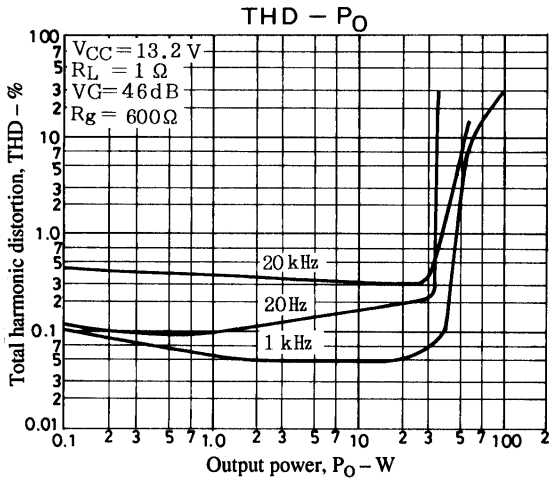
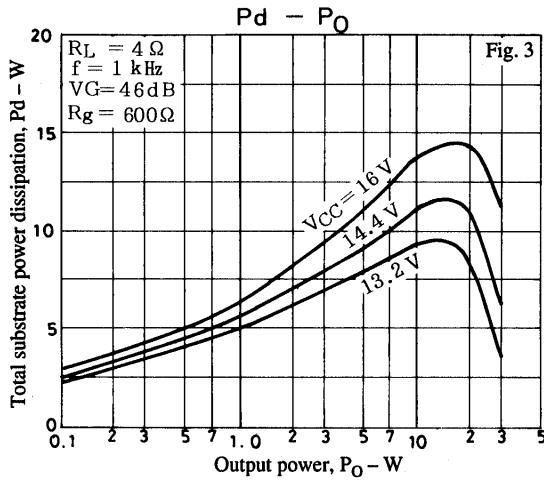
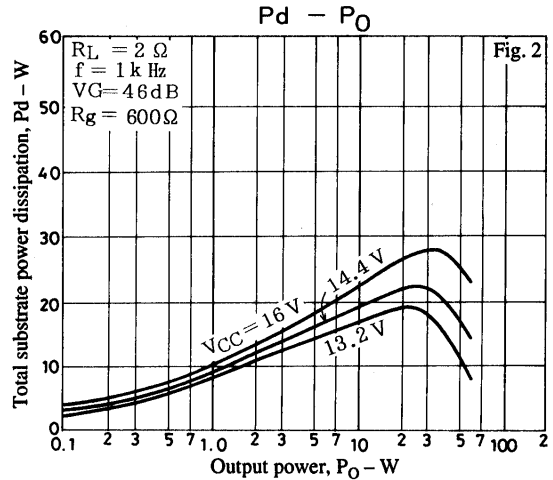
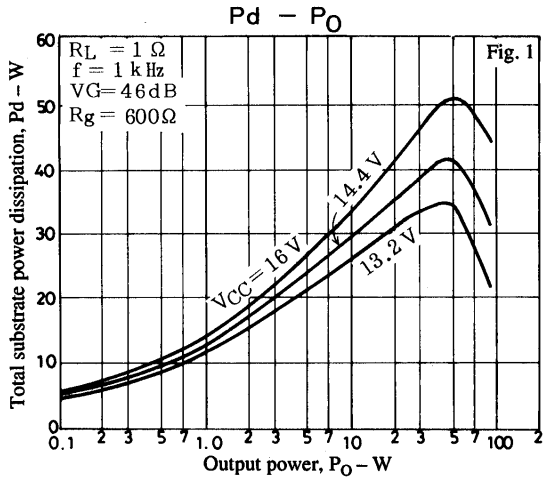

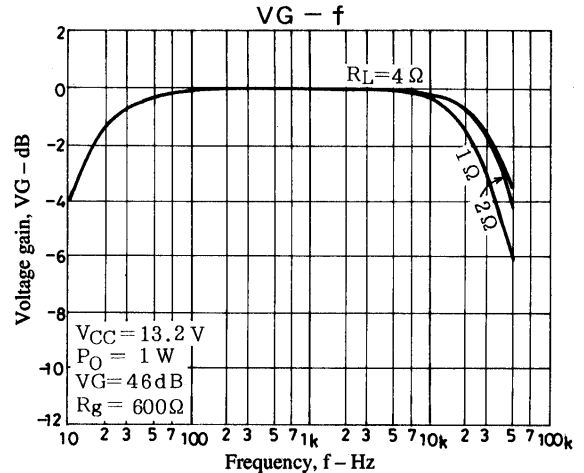
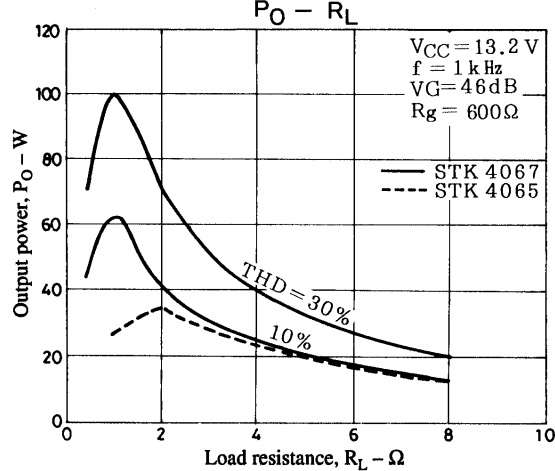
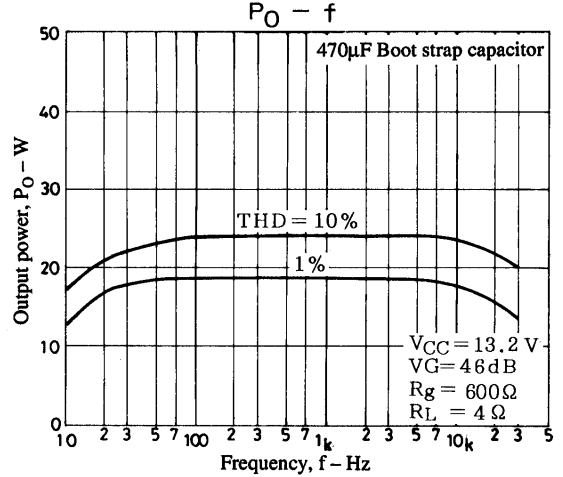
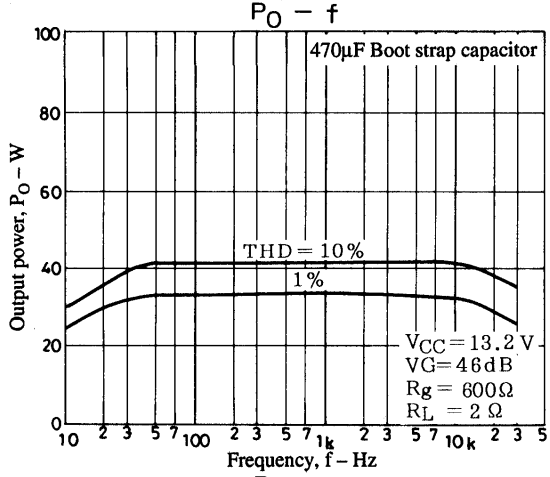
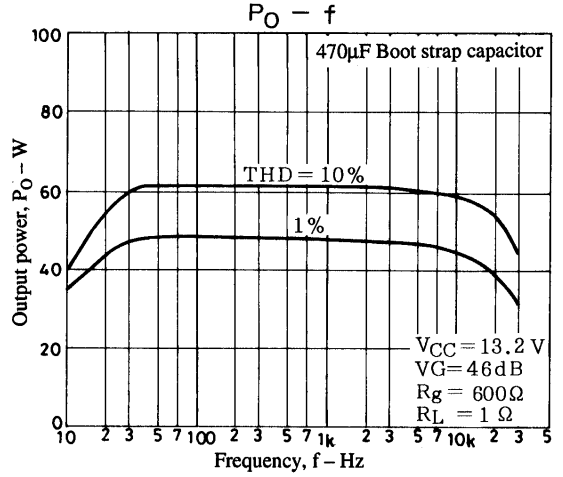
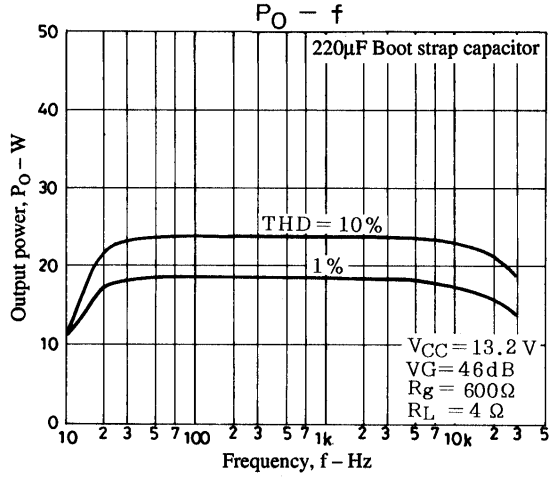
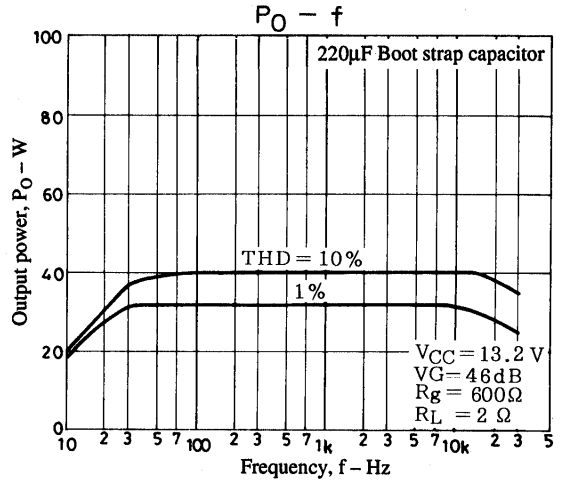
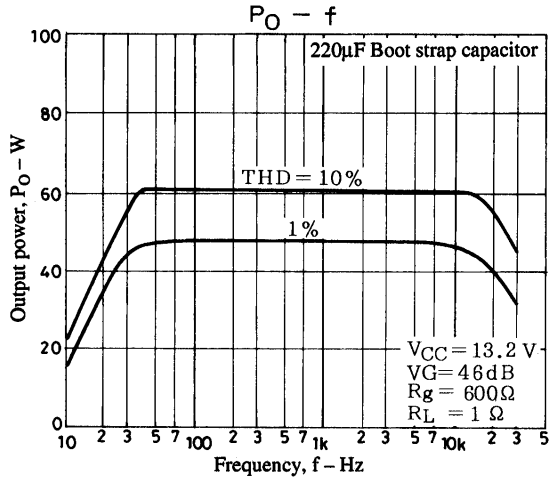

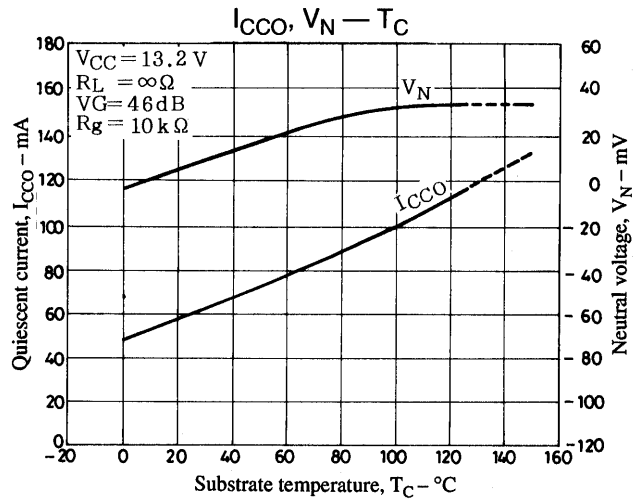
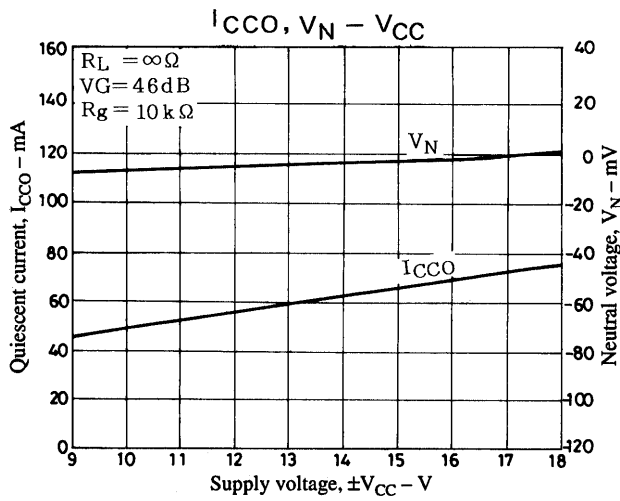

- No products described or contained herein are intended for use in surgical implants, life-support systems, aerospace equipment, nuclear power control systems, vehicles, disaster/crime-prevention equipment and the like, the failure of which may directly or indirectly cause injury, death or property loss.
- Anyone purchasing any products described or contained herein for an above-mentioned use shall:
  - ① Accept full responsibility and indemnify and defend SANYO ELECTRIC CO., LTD., its affiliates, subsidiaries and distributors and all their officers and employees, jointly and severally, against any and all claims and litigation and all damages, cost and expenses associated with such use:
  - ② Not impose any responsibility for any fault or negligence which may be cited in any such claim or litigation on SANYO ELECTRIC CO., LTD., its affiliates, subsidiaries and distributors or any of their officers and employees jointly or severally.
- Information (including circuit diagrams and circuit parameters) herein is for example only; it is not guaranteed for volume production. SANYO believes information herein is accurate and reliable, but no guarantees are made or implied regarding its use or any infringements of intellectual property rights or other rights of third parties.

This catalog provides information as of December, 1996. Specifications and information herein are subject to change without notice.