

# HW-104A

- High-sensitivity InSb Hall element.
- SMT package with inserting pin.
- Shipped in bulk(500pcs per pack).

Note : It is requested to read and accept "IMPORTANT NOTICE".

## •Absolute Maximum Ratings

Item	Symbol		Limit	Unit
Max. Input Current	$I_c$	Const. Current Drive	20	mA
Operating Temp. Range	$T_{opr.}$		-40 to +110	°C
Storage Temp. Range	$T_{stg.}$		-40 to +125	°C

## •Electrical Characteristics( $T_a=25^\circ\text{C}$ )

Item	Symbol	Conditions	Min.	Typ.	Max.	Unit
Output Hall Voltage	$V_H$	Const. Voltage Drive $B=50\text{mT}$ , $V_C=IV$	196			mV
Input Resistance	$R_{in}$	$B=0\text{mT}$ , $I_C=0.1\text{mA}$	240		550	$\Omega$
Output Resistance	$R_{out}$	$B=0\text{mT}$ , $I_C=0.1\text{mA}$	240		550	$\Omega$
Offset Voltage	$V_{os}$	$B=0\text{mT}$ , $V_C=IV$	-7		+7	mV
Temp. Coefficient of $V_H$	$\alpha V_H$	$B=50\text{mT}$ , $I_C=5\text{mA}$		-1.8		%/°C
Temp. Coefficient of $R_{in}$	$\alpha R_{in}$	$B=0\text{mT}$ , $I_C=0.1\text{mA}$		-1.8		%/°C
Dielectric Strength		100V D.C	1.0			M $\Omega$

Notes : 1.  $V_H = V_{HM} - V_{os}$  (VHM: meter indication)

$$2. \alpha V_H = \frac{1}{V_H(T_1)} \times \frac{V_H(T_3) - V_H(T_2)}{(T_3 - T_2)} \times 100$$

$$3. \alpha R_{in} = \frac{1}{R_{in}(T_1)} \times \frac{R_{in}(T_3) - R_{in}(T_2)}{(T_3 - T_2)} \times 100$$

$$T_1 = 20^\circ\text{C}, T_2 = 0^\circ\text{C}, T_3 = 40^\circ\text{C}$$

## •Dimensional Drawing (mm)

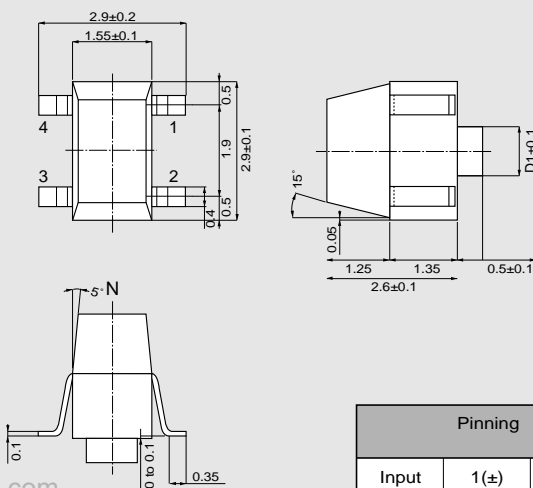

Please be aware that AKE products are not intended for use in life support equipment, devices, or systems. Use of AKE products in such applications requires the advance written approval of the appropriate AKE officer.

Certain applications using semiconductor devices may involve potential risks of personal injury, property damage, or loss of life. In order to minimize these risks, adequate design and operating safeguards should be provided by the customer to minimize inherent or procedural hazards. Inclusion of AKE products in such applications is understood to be fully at the risk of the customer using AKE devices or systems.



## •Input Current Derating Curve

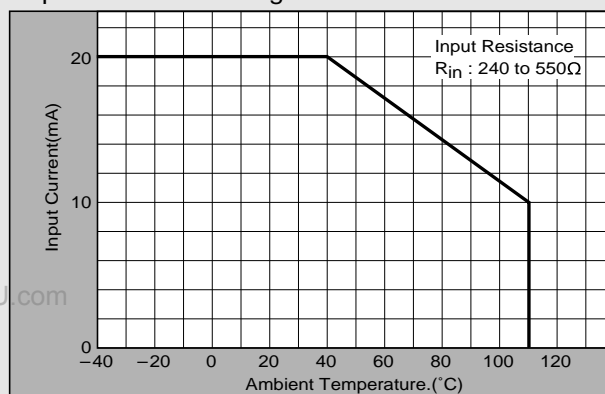

Note :  $R_{in}$  of Hall element decreases rapidly as ambient temperature increases. Ensure compliance with input current derating curve envelope, throughout the operating temperature range.

## •Input Voltage Derating Curve

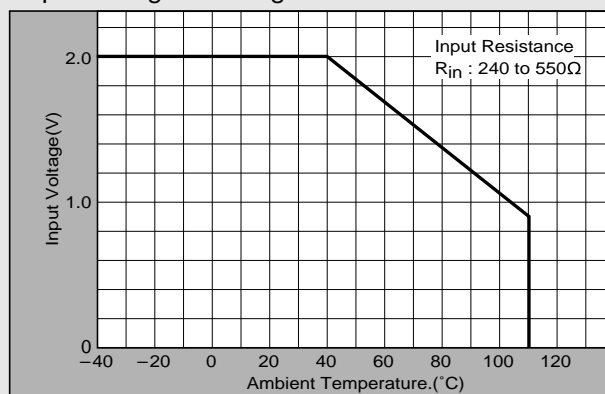

Note : For constant-voltage drive, stay within this input voltage derating curve envelope.

•Characteristic Curves

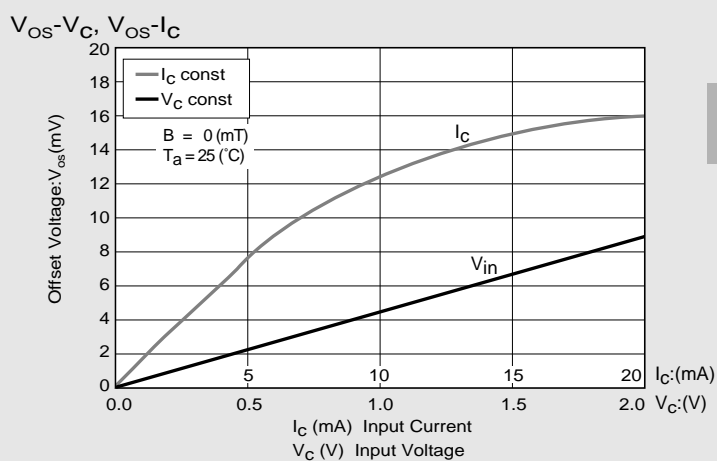
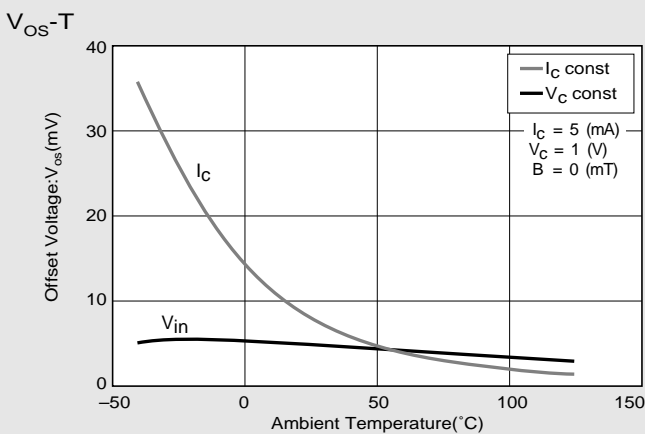
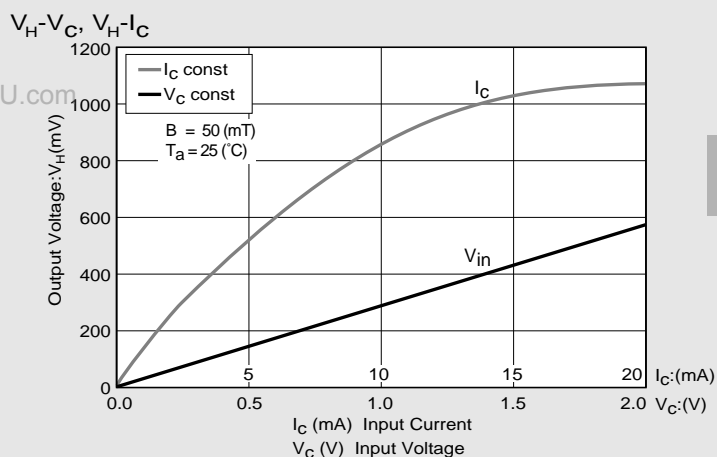
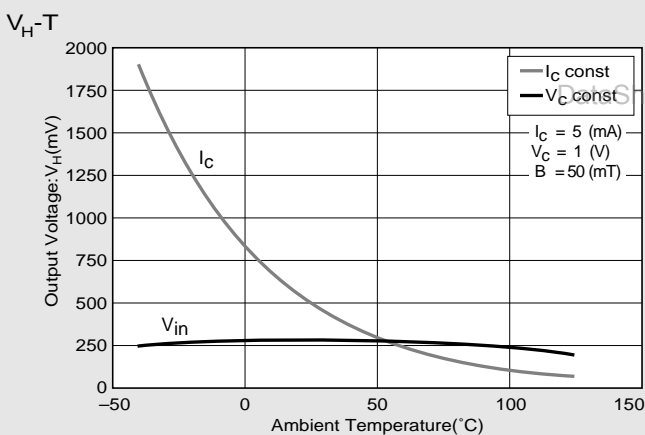
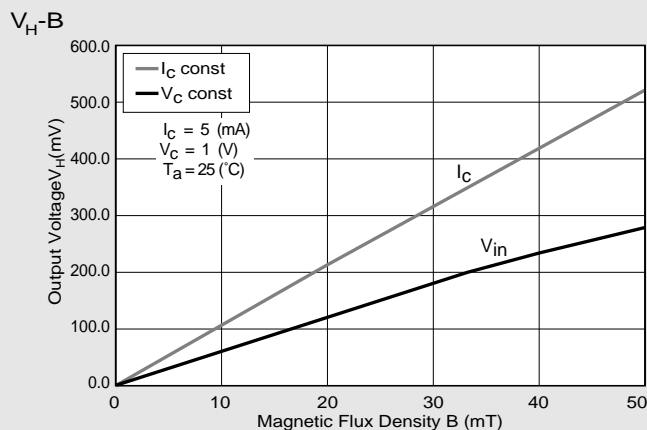
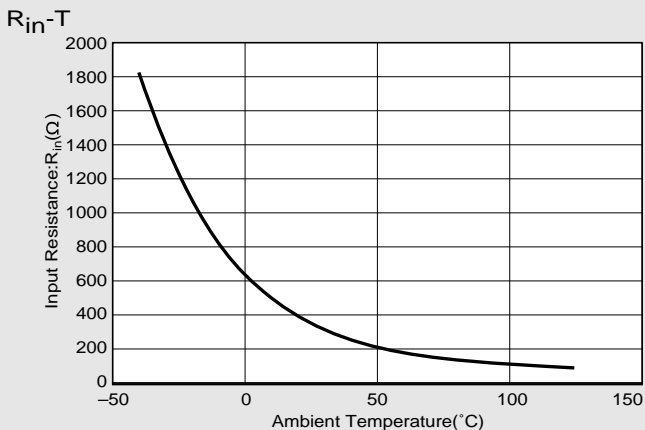

\*Magnetic Flux Density  
1(mT)=10(G)

In This Example :  $R_{in}=350(\Omega)$ ,  $V_{OS}=4.7(mV)$ ,  $V_C=1(V)$