

# 2064 THRU 2069

Data Sheet  
29305H†

## QUAD 1.5 A DARLINGTON SWITCHES

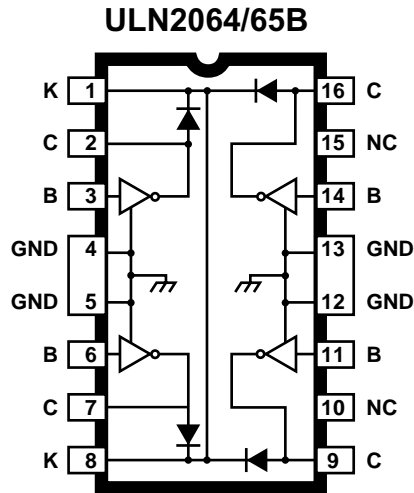

Dwg. No. A-9765A

### ABSOLUTE MAXIMUM RATINGS at +25°C Free-Air Temperature for Any One Driver (unless otherwise noted)

Output Voltage, $V_{CEX}$ .....	See Guide
Output Sustaining Voltage, $V_{CE(SUS)}$ .....	See Guide
Output Current, $I_{OUT}$ (Note 1) .....	1.75 A
Input Voltage, $V_{IN}$ .....	See Guide
Input Current, $I_B$ (Note 2) .....	25 mA
Supply Voltage, $V_S$ (ULN2068B/LB & 2069B/LB) ...	10 V
Total Package Power Dissipation, $P_D$ .....	See Graph
Operating Temperature Range, $T_A$ .....	-20°C to +85°C
Storage Temperature Range, $T_S$ .....	-55°C to -150°C

1. Allowable combinations of output current, number of outputs conducting, and duty cycle are shown on the following pages.
2. Input current may be limited by maximum allowable input voltage.

High-voltage, high-current Darlington arrays ULN2064B/LB through ULN2069B/LB are designed for interface between low-level logic and a variety of peripheral loads such as relays, solenoids, dc and stepper motors, magnetic print hammers, multiplexed LED and incandescent displays, heaters, and similar loads. Output off voltage ratings of 50 V and 80 V are available. These quad drivers can drive resistive loads to 480 watts (1.5 A x 80 V, 26% duty cycle). For inductive loads, sustaining voltages of 35 V and 50 V at 100 mA are specified.

Quad drivers ULN2064B/LB, ULN2065B/LB, ULN2068B/LB, and ULN2069B/LB are intended for use with TTL, low-speed TTL, and 5 V MOS logic. The ULN2065B/LB and ULN2069B/LB are selected for the 80 V minimum output breakdown specification. The ULN2068B/LB and ULN2069B/LB have pre-driver stages and are recommended for applications requiring high gain (low input-current loading). Quad-driver arrays are supplied with heat-sink contact tabs in 16-pin plastic DIPs (suffix 'B') and 20-lead surface-mountable wide-body SOICs (suffix 'LB').

### FEATURES

- TTL, DTL, MOS, CMOS Compatible Inputs
- Transient-Protected Outputs
- Loads to 480 Watts
- Heat-Sink Contact Tabs
- Automotive Capable

Always order by complete part number, e.g., **ULN2068B** .



# 2064 THRU 2069 QUAD 1.5 A DARLINGTON SWITCHES

## SELECTION GUIDE

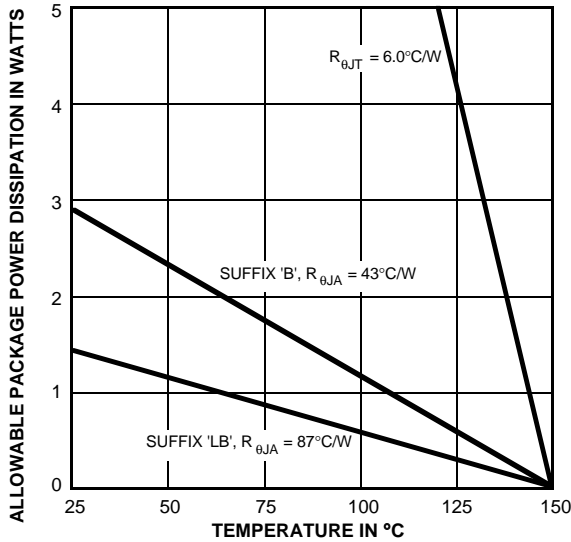

Dwg. GP-049-3A

Part Number*	Max. $V_{CEX}$	Min. $V_{CE(SUS)}$	Max. $V_{IN}$	Application
ULN2064B ULN2064LB	50 V	35 V	15 V	TTL, DTL, Schottky TTL, and 5 V CMOS
ULN2065B ULN2065LB	80 V	50 V	15 V	
ULN2068B ULN2068LB	50 V	35 V	15 V	TTL, DTL, Schottky TTL, and 5 V CMOS
ULN2069B ULN2069LB	80 V	50 V	15 V	

\* Suffix 'B' is a 16-pin DIP; 'LB' is a 20-lead SOIC.

## TEST FIGURES

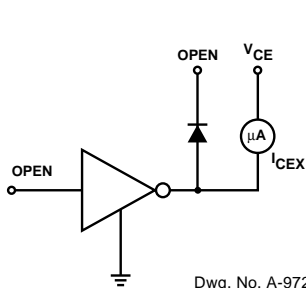

FIGURE 1

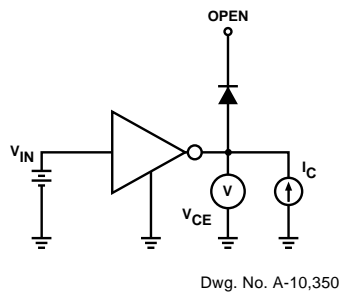

FIGURE 2

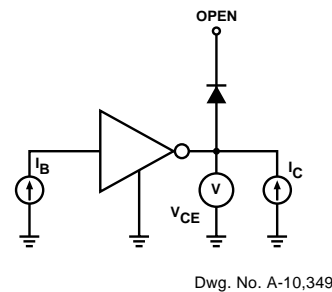

FIGURE 3

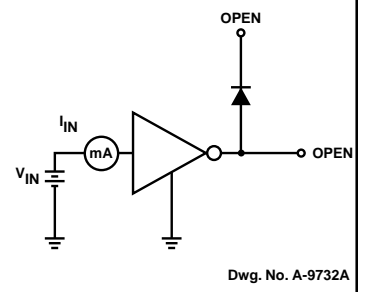

FIGURE 4

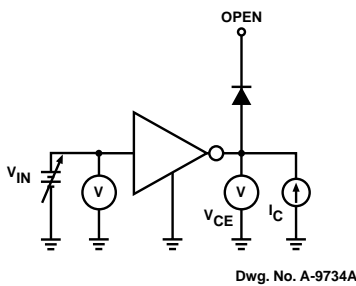

FIGURE 5

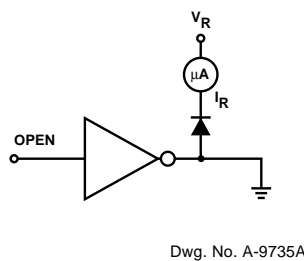

FIGURE 6

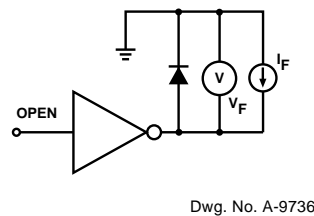

FIGURE 7

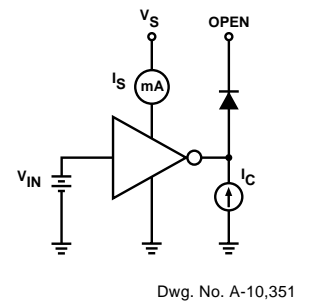
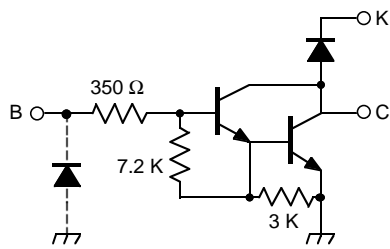

FIGURE 8

# 2064 THRU 2069 QUAD 1.5 A DARLINGTON SWITCHES

## PARTIAL SCHEMATIC



Dwg. FP-052

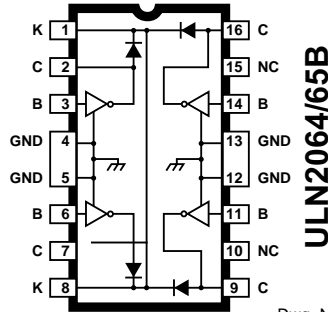

Dwg. No. A-9765A

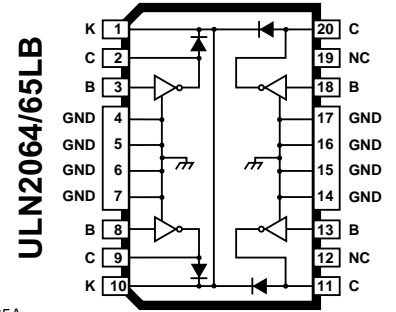

Dwg. No. A-14,326

## ELECTRICAL CHARACTERISTICS at +25°C (unless otherwise noted).

Characteristic	Symbol	Test Fig.	Applicable Devices	Test Conditions	Limits		
					Min.	Max.	Units
Output Leakage Current	$I_{CEX}$	1	ULN2064B/LB	$V_{CE} = 50 \text{ V}$	—	100	$\mu\text{A}$
				$V_{CE} = 50 \text{ V}, T_A = 70^\circ\text{C}$	—	500	$\mu\text{A}$
			ULN2065B/LB	$V_{CE} = 80 \text{ V}$	—	100	$\mu\text{A}$
				$V_{CE} = 80 \text{ V}, T_A = 70^\circ\text{C}$	—	500	$\mu\text{A}$
Output Sustaining Voltage	$V_{CE(SUS)}$	2	ULN2064B/LB	$I_C = 100 \text{ mA}, V_{IN} = 0.4 \text{ V}$	35	—	V
			ULN2065B/LB	$I_C = 100 \text{ mA}, V_{IN} = 0.4 \text{ V}$	50	—	V
Collector-Emitter Saturation Voltage	$V_{CE(SAT)}$	3	All	$I_C = 500 \text{ mA}, I_B = 625 \mu\text{A}$	—	1.1	V
				$I_C = 750 \text{ mA}, I_B = 935 \mu\text{A}$	—	1.2	V
				$I_C = 1.0 \text{ A}, I_B = 1.25 \text{ mA}$	—	1.3	V
				$I_C = 1.25 \text{ A}, I_B = 2.0 \text{ mA}$	—	1.4	V
			ULN2065B/LB	$I_C = 1.5 \text{ A}, I_B = 2.25 \text{ mA}$	—	1.5	V
Input Current	$I_{IN(ON)}$	4	All	$V_{IN} = 2.4 \text{ V}$	1.4	4.3	mA
				$V_{IN} = 3.75 \text{ V}$	3.3	9.6	mA
Input Voltage	$V_{IN(ON)}$	5	All	$V_{CE} = 2.0 \text{ V}, I_C = 1.0 \text{ A}$	—	2.0	V
			ULN2064B/LB	$V_{CE} = 2.0 \text{ V}, I_C = 1.25 \text{ A}$	—	2.5	V
			ULN2065B/LB	$V_{CE} = 2.0 \text{ V}, I_C = 1.5 \text{ A}$	—	2.5	V
Turn-On Delay	$t_{PLH}$	—	All	$0.5 E_{in}$ to $0.5 E_{out}$	—	1.0	$\mu\text{s}$
Turn-Off Delay	$t_{PHL}$	—	All	$0.5 E_{in}$ to $0.5 E_{out}$	—	1.5	$\mu\text{s}$
Clamp Diode Leakage Current	$I_R$	6	ULN2064B/LB	$V_R = 50 \text{ V}$	—	50	$\mu\text{A}$
				$V_R = 50 \text{ V}, T_A = 70^\circ\text{C}$	—	100	$\mu\text{A}$
			ULN2065B/LB	$V_R = 80 \text{ V}$	—	50	$\mu\text{A}$
				$V_R = 80 \text{ V}, T_A = 70^\circ\text{C}$	—	100	$\mu\text{A}$
Clamp Diode Forward Voltage	$V_F$	7	All	$I_F = 1.0 \text{ A}$	—	1.75	V
				$I_F = 1.5 \text{ A}$	—	2.0	V

# 2064 THRU 2069 QUAD 1.5 A DARLINGTON SWITCHES

## PARTIAL SCHEMATIC

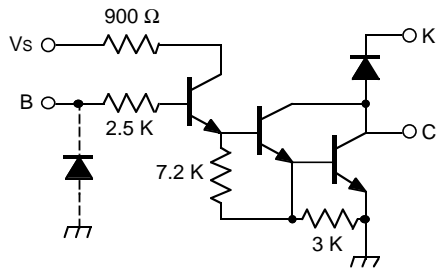

Dwg. FP-052-1

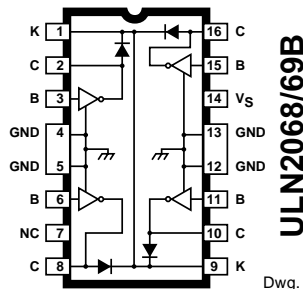

ULN2068/69B

Dwg. No. A-10,310

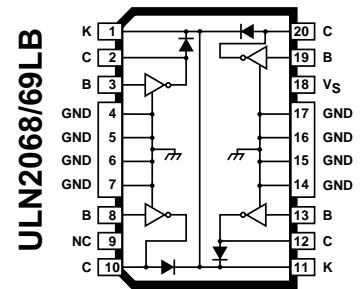

ULN2068/69LB

Dwg. No. A-14,327

## ELECTRICAL CHARACTERISTICS at +25°C, $V_S = 5.0\text{ V}$ (unless otherwise noted).

Characteristic	Symbol	Test Fig.	Applicable Devices	Test Conditions	Limits		
					Min.	Max.	Units
Output Leakage Current	$I_{CEX}$	1	ULN2068B/LB	$V_{CE} = 50\text{ V}$	—	100	$\mu\text{A}$
				$V_{CE} = 50\text{ V}, T_A = 70^\circ\text{C}$	—	500	$\mu\text{A}$
			ULN2069B/LB	$V_{CE} = 80\text{ V}$	—	100	$\mu\text{A}$
				$V_{CE} = 80\text{ V}, T_A = 70^\circ\text{C}$	—	500	$\mu\text{A}$
Output Sustaining Voltage	$V_{CE(SUS)}$	2	ULN2068B/LB	$I_C = 100\text{ mA}, V_{IN} = 0.4\text{ V}$	35	—	V
			ULN2069B/LB	$I_C = 100\text{ mA}, V_{IN} = 0.4\text{ V}$	50	—	V
Collector-Emitter Saturation Voltage	$V_{CE(SAT)}$	3	All	$I_C = 500\text{ mA}, V_{IN} = 2.75\text{ V}$	—	1.1	V
				$I_C = 750\text{ mA}, V_{IN} = 2.75\text{ V}$	—	1.2	V
				$I_C = 1.0\text{ A}, V_{IN} = 2.75\text{ V}$	—	1.3	V
				$I_C = 1.25\text{ A}, V_{IN} = 2.75\text{ V}$	—	1.4	V
			ULN2069B/LB	$I_C = 1.5\text{ A}, V_{IN} = 2.75\text{ V}$	—	1.5	V
Input Current	$I_{IN(ON)}$	4	All	$V_{IN} = 2.75\text{ V}$	—	550	$\mu\text{A}$
				$V_{IN} = 3.75\text{ V}$	—	1000	$\mu\text{A}$
Input Voltage	$V_{IN(ON)}$	5	ULN2068B/LB	$V_{CE} = 2.0\text{ V}, I_C = 1.25\text{ A}$	—	2.75	V
			ULN2069B	$V_{CE} = 2.0\text{ V}, I_C = 1.5\text{ A}$	—	2.75	V
Supply Current	$I_S$	8	All	$I_C = 500\text{ mA}, V_{IN} = 2.75\text{ V}$	—	6.0	mA
Turn-On Delay	$t_{PLH}$	—	All	$0.5 E_{in}$ to $0.5 E_{out}$	—	1.0	$\mu\text{s}$
Turn-Off Delay	$t_{PHL}$	—	All	$0.5 E_{in}$ to $0.5 E_{out}, I_C = 1.25\text{ A}$	—	1.5	$\mu\text{s}$
Clamp Diode Leakage Current	$I_R$	6	ULN2068B/LB	$V_R = 50\text{ V}$	—	50	$\mu\text{A}$
				$V_R = 50\text{ V}, T_A = 70^\circ\text{C}$	—	100	$\mu\text{A}$
			ULN2069B/LB	$V_R = 80\text{ V}$	—	50	$\mu\text{A}$
				$V_R = 80\text{ V}, T_A = 70^\circ\text{C}$	—	100	$\mu\text{A}$
Clamp Diode Forward Voltage	$V_F$	7	All	$I_F = 1.0\text{ A}$	—	1.75	V
				$I_F = 1.5\text{ A}$	—	2.0	V

# 2064 THRU 2069 QUAD 1.5 A DARLINGTON SWITCHES

## PEAK COLLECTOR CURRENT AS A FUNCTION OF DUTY CYCLE (Dual in-line packaged devices)

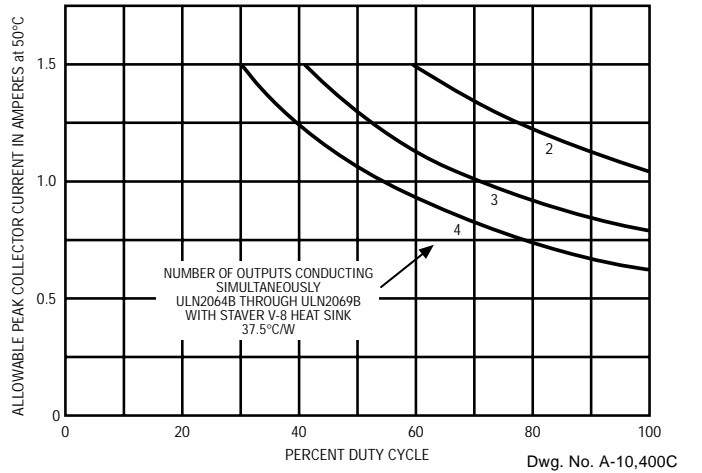
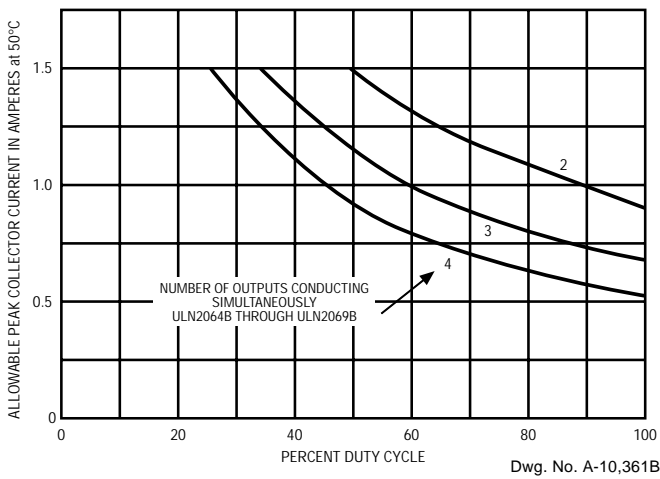
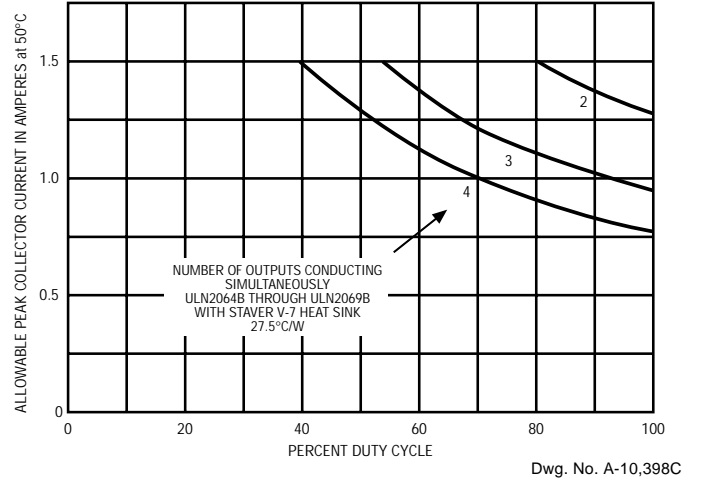
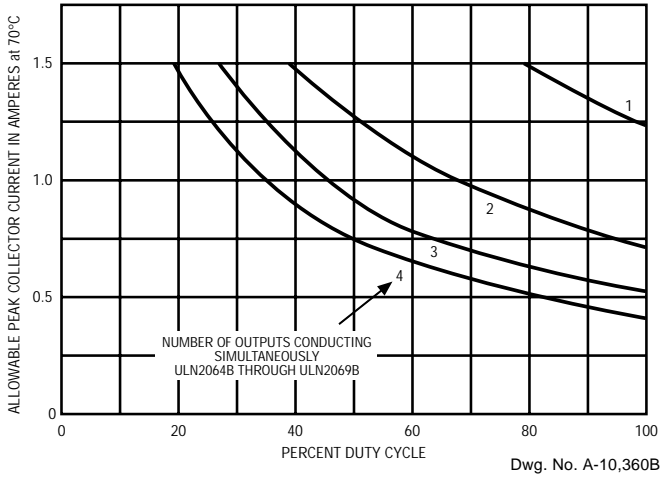

# 2064 THRU 2069 QUAD 1.5 A DARLINGTON SWITCHES

## PEAK COLLECTOR CURRENT AS A FUNCTION OF DUTY CYCLE (Dual in-line packaged devices)

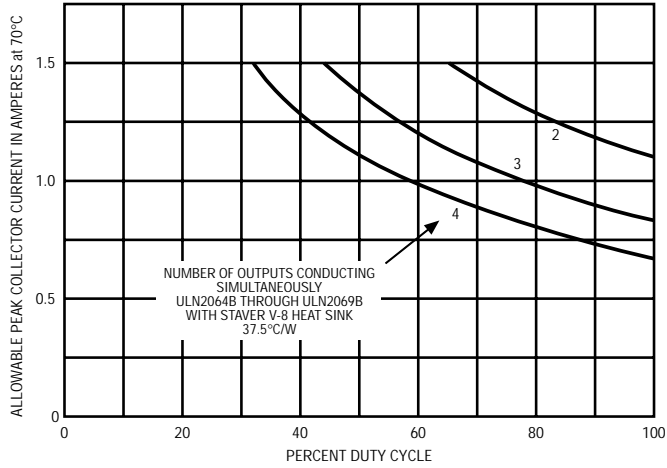

Dwg. No. A-10,399C

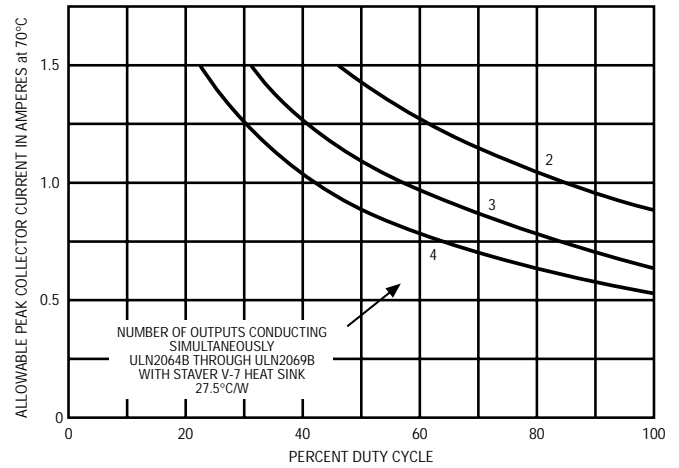

Dwg. No. A-10,401C

## PEAK COLLECTOR CURRENT AS A FUNCTION OF DUTY CYCLE (SOIC packaged devices)

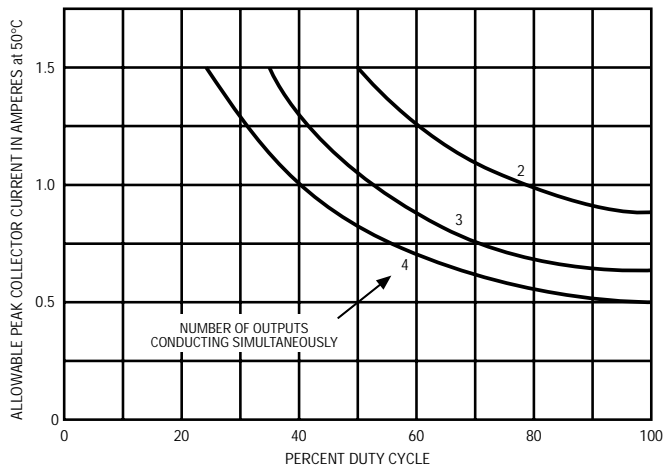

Dwg. GP-045

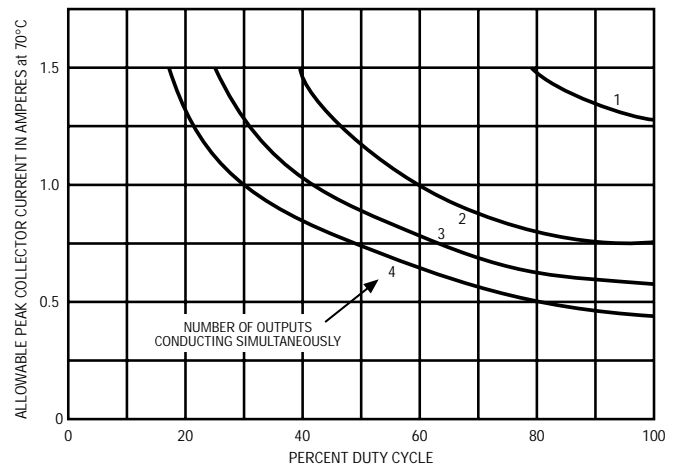

Dwg. GP-045-1

# 2064 THRU 2069 QUAD 1.5 A DARLINGTON SWITCHES

## INPUT CURRENT AS A FUNCTION OF INPUT VOLTAGE AT +25°C

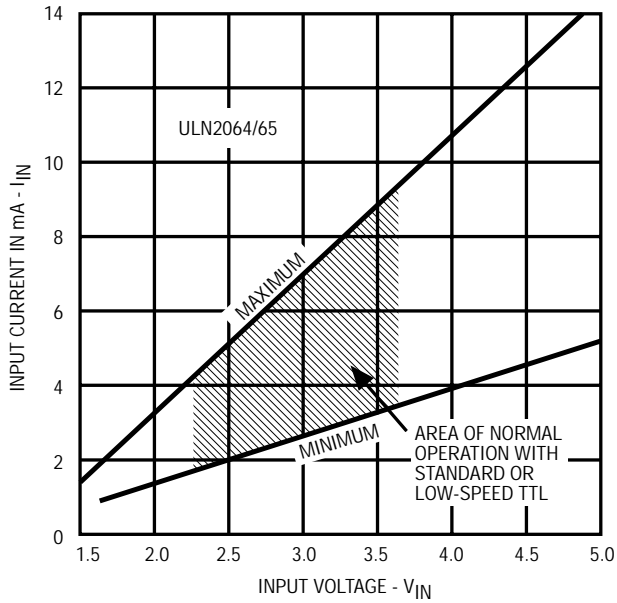

Dwg. No. A-10,363C

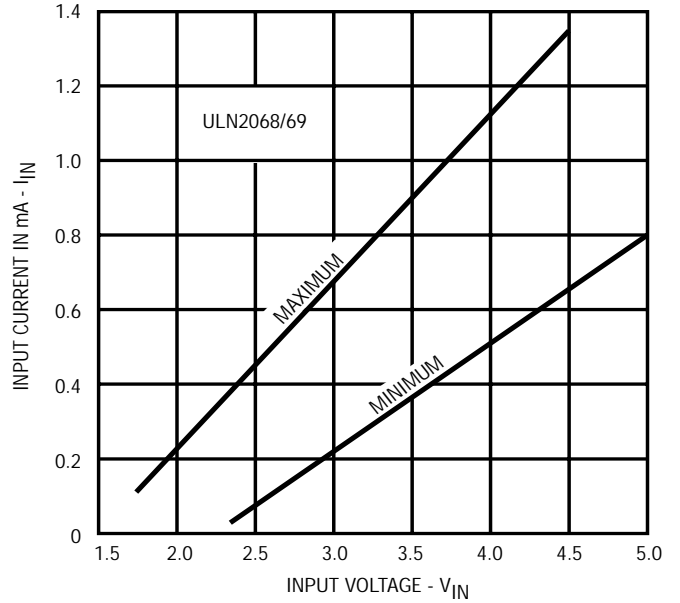

Dwg. No. A-12,306A

## COLLECTOR CURRENT AS A FUNCTION OF INPUT CURRENT AT +25°C

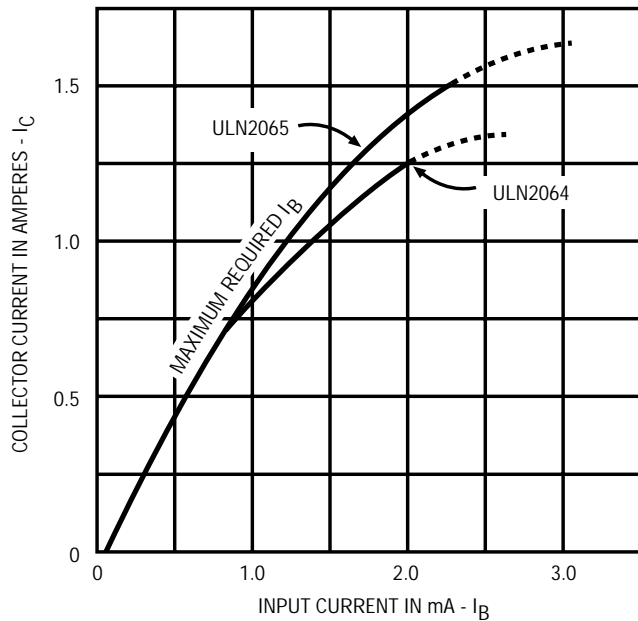

Dwg. No. A-10,358C

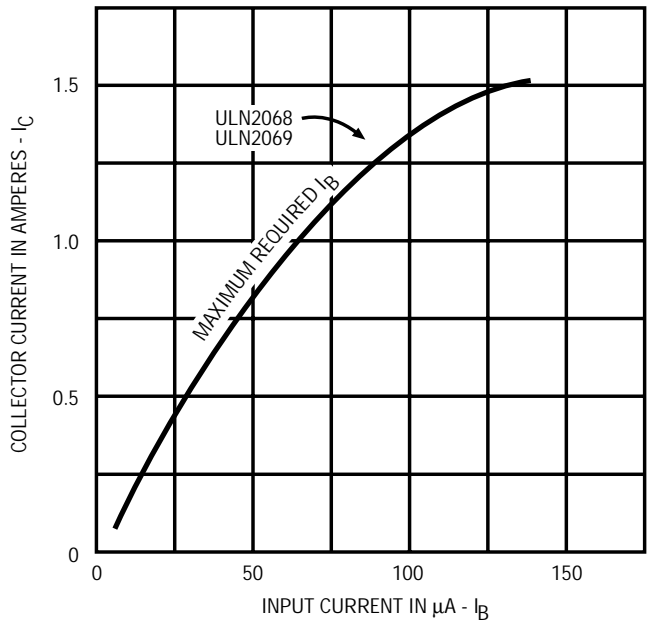

Dwg. No. A-12,305A

**2064 THRU 2069**  
**QUAD 1.5 A DARLINGTON**  
**SWITCHES**

**TYPICAL APPLICATION**

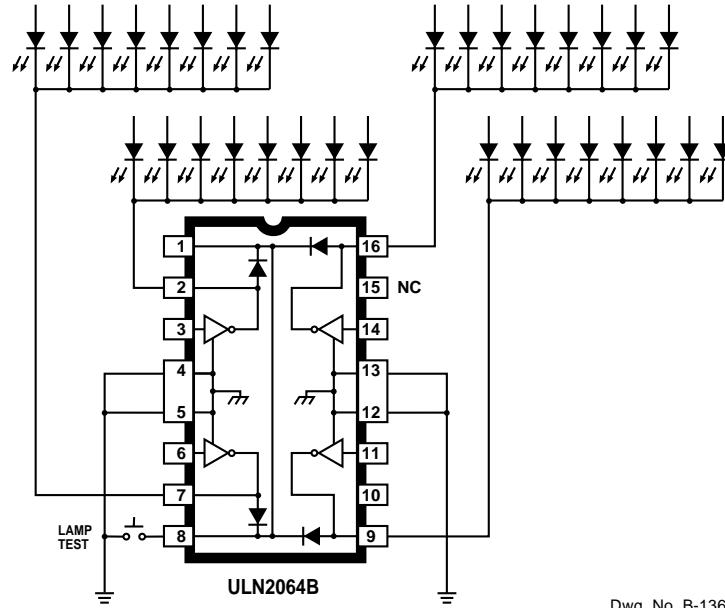

Dwg. No. B-1365

**COMMON-CATHODE LED DRIVERS**

(Types ULN2065B, ULN2065LB, ULN2068B, and ULN2068LB are also applicable)



# 2064 THRU 2069 QUAD 1.5 A DARLINGTON SWITCHES

## ULN2064B, ULN2065B, ULN2068B, and ULN2069B

### Dimensions in Inches (controlling dimensions)

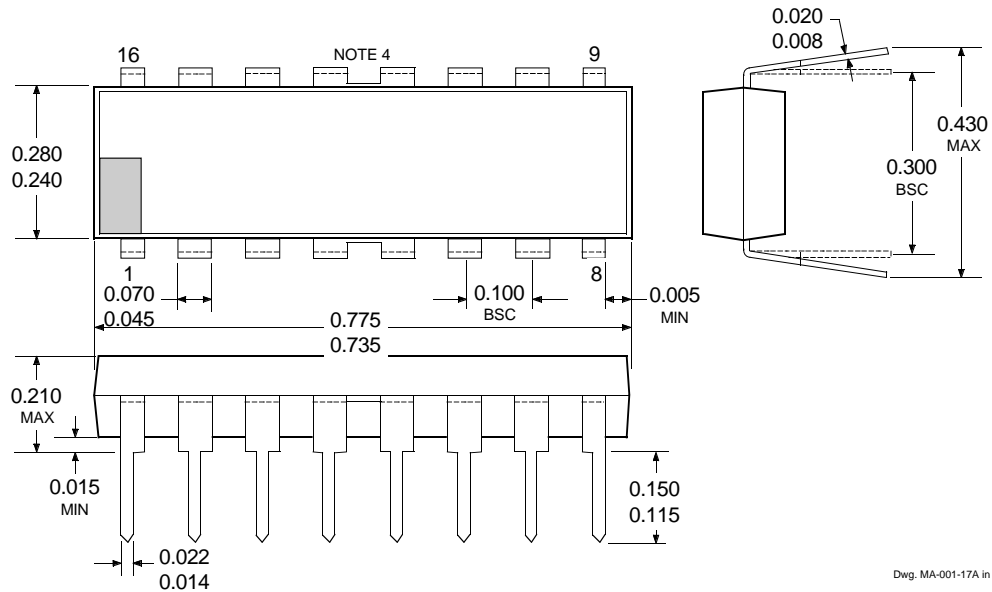

### Dimensions in Millimeters (for reference only)

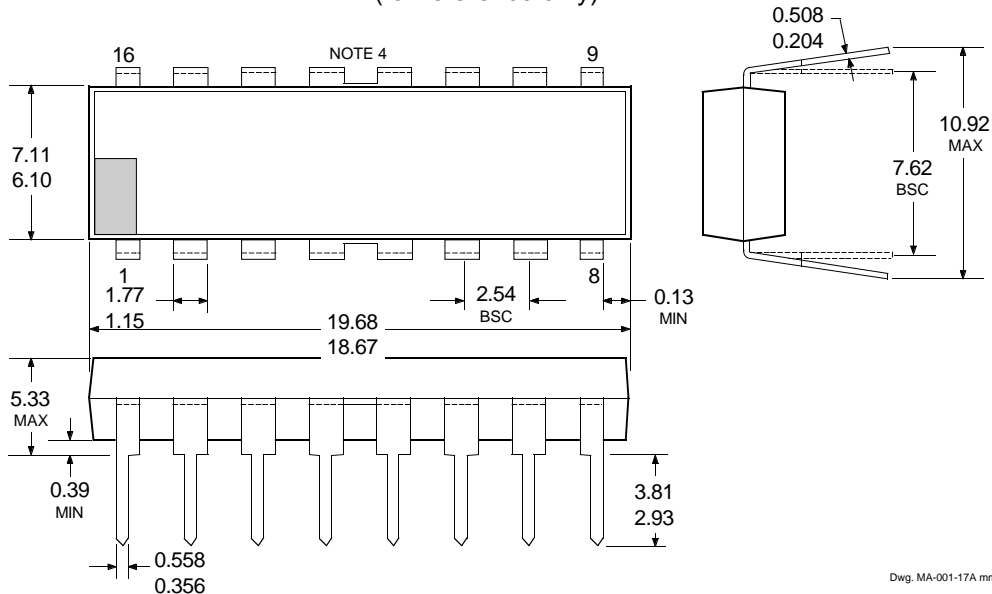

- NOTES:
1. Exact body and lead configuration at vendor's option within limits shown.
  2. Lead spacing tolerance is non-cumulative.
  3. Lead thickness is measured at seating plane or below.
  4. Webbed lead frame. Leads 4, 5, 12, and 13 are internally one piece.
  5. Supplied in standard sticks/tubes of 25 devices.

**2064 THRU 2069**  
**QUAD 1.5 A DARLINGTON**  
**SWITCHES**

**ULN2064LB, ULN2065LB, ULN2068LB, and ULN2069LB**  
 (add "TR" to part number for tape and reel)

**Dimensions in Inches**  
 (for reference only)

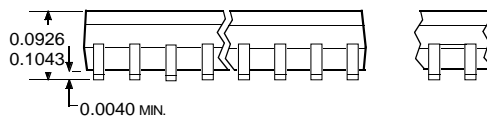
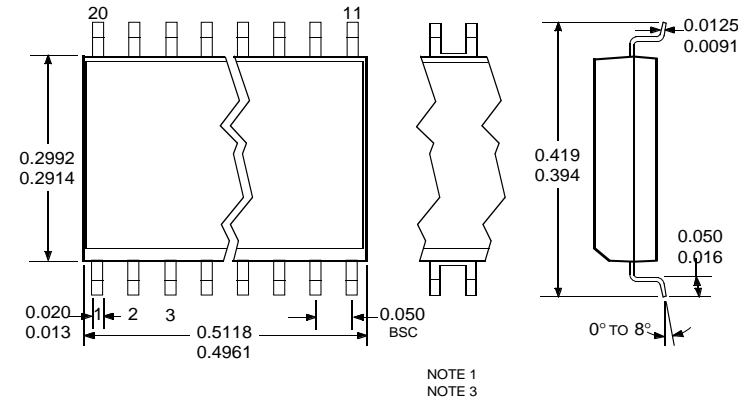

Dwg. MA-008-21A in

**Dimensions in Millimeters**  
 (controlling dimensions)

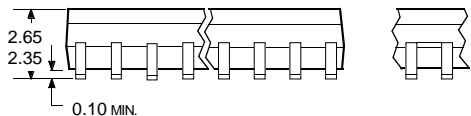
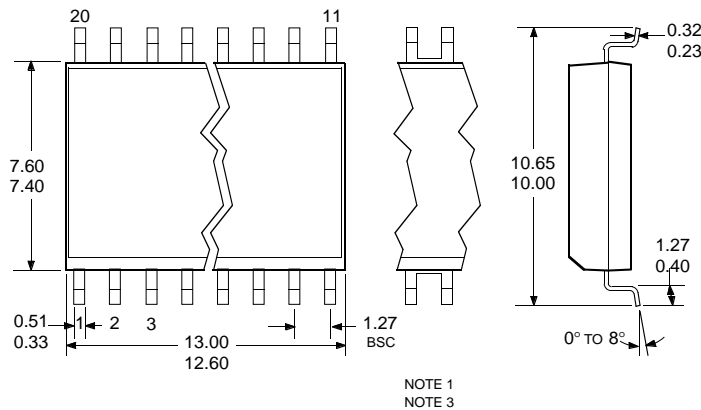

Dwg. MA-008-21A mm

- NOTES:
1. Exact body and lead configuration at vendor's option within limits shown.
  2. Lead spacing tolerance is non-cumulative.
  3. Webbed lead frame. Leads 4 through 7 and 14 through 17 are internally one piece.
  4. Lead thickness is measured at seating plane or below.
  5. Supplied in standard sticks/tubes of 37 devices or add "TR" to part number for tape and reel.

**2064 THRU 2069**  
**QUAD 1.5 A DARLINGTON**  
**SWITCHES**

*The products described here are manufactured under one or more U.S. patents or U.S. patents pending.*

*Allegro MicroSystems, Inc. reserves the right to make, from time to time, such departures from the detail specifications as may be required to permit improvements in the performance, reliability, or manufacturability of its products. Before placing an order, the user is cautioned to verify that the information being relied upon is current.*

*Allegro products are not authorized for use as critical components in life-support devices or systems without express written approval.*

*The information included herein is believed to be accurate and reliable. However, Allegro MicroSystems, Inc. assumes no responsibility for its use; nor for any infringement of patents or other rights of third parties which may result from its use.*

**2064 THRU 2069**  
**QUAD 1.5 A DARLINGTON**  
**SWITCHES**

**POWER SINK DRIVERS**

IN ORDER OF 1) OUTPUT CURRENT, 2) OUTPUT VOLTAGE, 3) NUMBER OF DRIVERS

Output Ratings *			Features					Part Number <sup>†</sup>	
mA	V	#	Serial Input	Latched Drivers	Diode Clamp	Outputs	Internal Protection		
75	17	8	X	X	–	constant current	–	6275	
	17	16	X	X	–	constant current	–	6276	
100	20	8	–	–	–	saturated	–	2595	
	30	32	X	X	–	–	–	5833	
	40	32	X	X	–	saturated	–	5832	
	50	8	addressable decoder/driver			–	DMOS	–	6B259
	50	8	–	X	–	DMOS	–	6B273	
	50	8	X	X	–	DMOS	–	6B595	
120	24	8	X	X	–	constant current	–	6277	
250	50	8	addressable decoder/driver			–	DMOS	–	6259
	50	8	–	X	–	DMOS	–	6273	
	50	8	X	X	–	DMOS	–	6595	
50	8	8	–	–	X	saturated	–	2596	
	60	4	–	–	X	saturated	X	2557	
350	50	4	–	X	X	–	–	5800	
	50	7	–	–	X	–	–	2003	
	50	7	–	–	X	–	–	2004	
	50	8	–	–	X	–	–	2803	
	50	8	–	X	X	–	–	5801	
	50	8	X	X	–	–	–	5821	
	50	8	X	X	X	–	–	5841	
	50	8	addressable decoder/driver			–	DMOS	–	6A259
	50	8	X	X	–	DMOS	–	6A595	
	80	8	X	X	–	–	–	5822	
	80	8	X	X	X	–	–	5842	
	95	7	–	–	X	–	–	2023	
	95	7	–	–	X	–	–	2024	
450	30	28	dual 4- to 14-line decoder/driver			–	–	6817	
600	60	4	–	–	–	saturated	X	2547	
	60	4	–	–	X	saturated	X	2549 and 2559	
700	60	4	–	–	X	saturated	X	2543	
750	50	8	–	–	X	saturated	–	2597	
1000	46	4	stepper motor controller/driver			MOS	–	7024 and 7029	
1200	46	4	microstepping controller/driver			MOS	–	7042	
1250	50	4	stepper motor translator/driver			–	X	5804	
1800	50	4	–	–	X	–	–	2540	
3000	46	4	stepper motor controller/driver			MOS	–	7026	
	46	4	microstepping controller/driver			MOS	–	7044	
4000	50	4	–	–	X	–	–	2878	

\* Current is maximum specified test condition, voltage is maximum rating. See specification for sustaining voltage limits or over-current protection voltage limits.

† Complete part number includes additional characters to indicate operating temperature range and package style.