

# AN1741 (AN6570), AN1741S (AN6570S), AN6573

## Single Operational Amplifiers

### Overview

The AN1741 (AN6570), the AN1741S (AN6570S), and the AN6573 are single-type operational amplifier with a phase compensation circuit built-in and also an output short-circuit protection circuit built-in, so that they are highly stable and can be used widely in various electronic circuits

### Features

- Phase compensation circuit built-in
- High common mode input range, no latch-up
- Short circuit protection
- Low input offset voltage :  $V_{I(\text{offset})} = 0.5\text{mV typ.}$
- Low input offset current :  $I_{IO} = 10\text{nA typ.}$
- Offset null circuit

### Block Diagrams

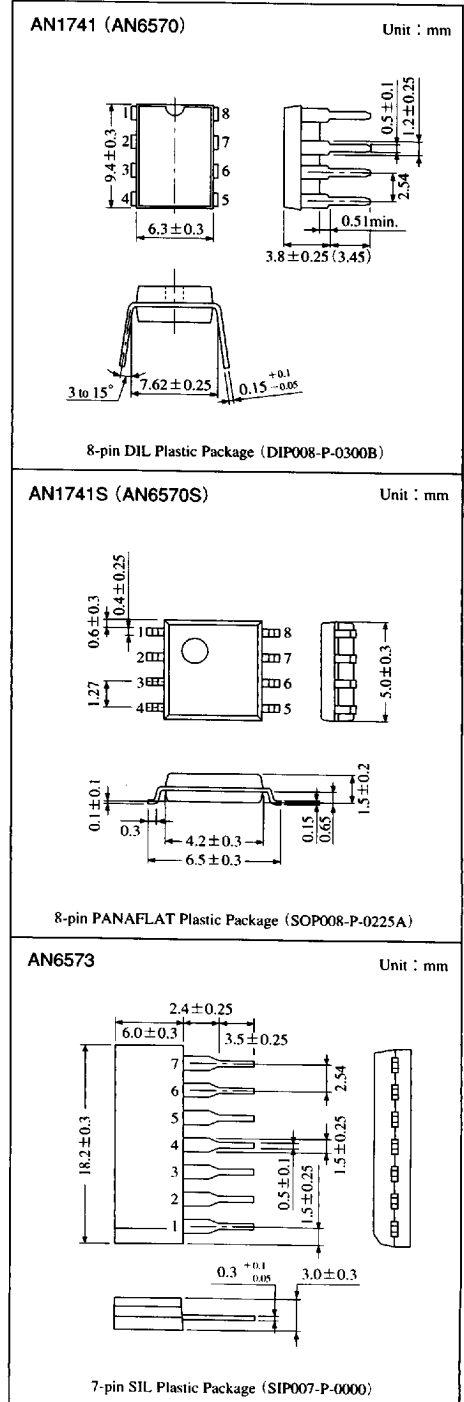
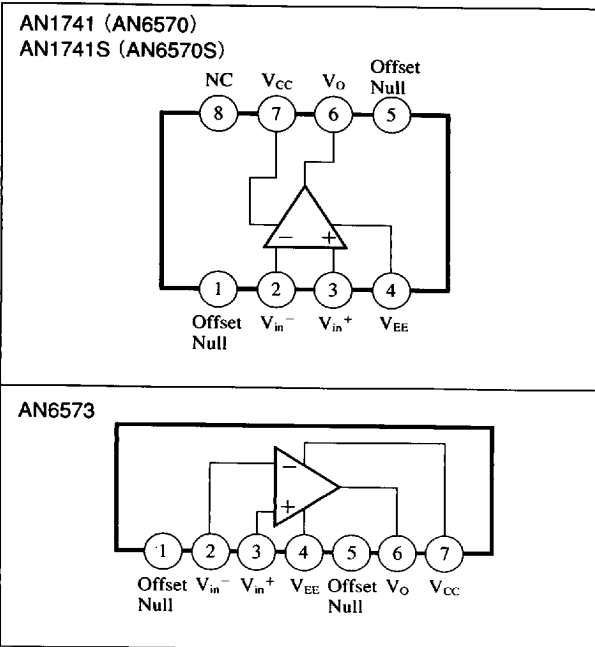

Operational Amplifiers

6932852 0012387 T79

### Pin Descriptions

(AN1741 (AN6570), AN1741S (AN6570S))

Pin No.	Pin name
1	Offset Null
2	inverting input
3	Non inverting input
4	$V_{EE}$
5	Offset Null
6	Output
7	$V_{CC}$
8	NC

(AN6573)

Pin No.	Pin name
1	Offset Null
2	inverting input
3	Non inverting input
4	$V_{EE}$
5	Offset Null
6	Output
7	$V_{CC}$

### Absolute Maximum Ratings ( $T_a = 25^\circ\text{C}$ )

Parameter		Symbol	Rating	Unit
Voltage	Supply voltage	$V_{CC}$	$\pm 18$	V
	Differential input voltage	$V_{ID}$	$\pm 30$	V
	Common-mode input voltage	$V_{ICM}$	$\pm 15$	V
Power dissipation	AN1741 (AN6570), AN6573	$P_D$	500	mW
	AN1741S (AN6570S)		360	
Operating ambient temperature		$T_{opr}$	$-20$ to $+75$	$^\circ\text{C}$
Storage temperature	AN1741 (AN6570), AN6573	$T_{sig}$	$-55$ to $+150$	$^\circ\text{C}$
	AN1741S (AN6570S)		$-55$ to $+125$	

### Electrical Characteristics ( $V_{CC} = 15\text{V}$ , $V_{EE} = -15\text{V}$ , $T_a = 25^\circ\text{C}$ )

Parameter	Symbol	Condition	min	typ	max	Unit
Input offset voltage	$V_{I(\text{offset})}$	$R_S \leq 10\text{k}\Omega$	—	0.5	4	mV
Input offset current	$I_{IO}$		—	10	100	nA
Input bias current	$I_{bias}$		—	50	250	nA
Voltage gain	$G_V$	$R_L \geq 2\text{k}\Omega$ , $V_O = \pm 10\text{V}$	86	106	—	dB
Maximum output voltage	$V_{O(\text{max.})}$	$R_L \geq 10\text{k}\Omega$	$\pm 12$	$\pm 14$	—	V
		$R_L \geq 2\text{k}\Omega$	$\pm 10$	$\pm 13$	—	V
Common-mode input voltage width	$V_{CM}$		$\pm 12$	$\pm 13$	—	V
Common-mode rejection ratio	CMR	$R_S \leq 10\text{k}\Omega$	70	90	—	dB
Supply voltage rejection ratio	SVR	$R_S \leq 10\text{k}\Omega$	—	30	150	$\mu\text{V/V}$
Supply current	$I_{CC}$	$R_L = \infty$	—	—	2.8	mA
Power consumption	$P_C$	$R_L = \infty$	—	—	85	mW
Output short-circuit current	$I_{O(\text{short})}$		—	$\pm 20$	—	mA
Slew rate	SR		—	0.7	—	V/ $\mu\text{s}$

6932852 0012388 905

Panasonic

■ Characteristics Curve

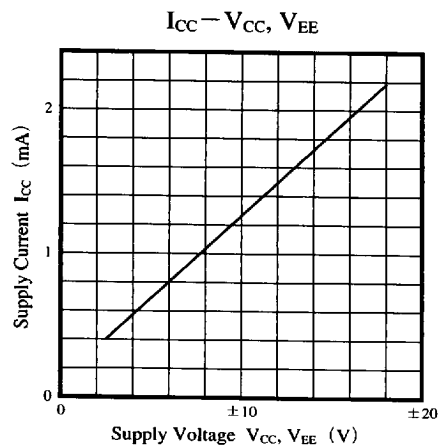
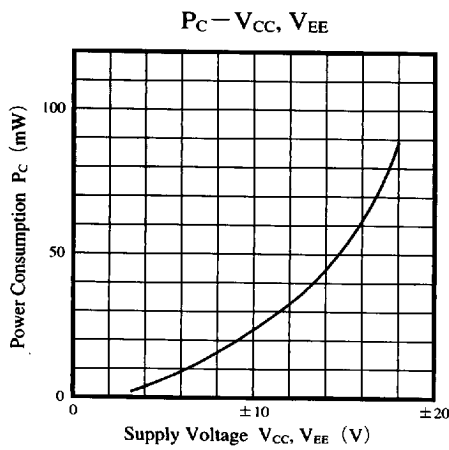
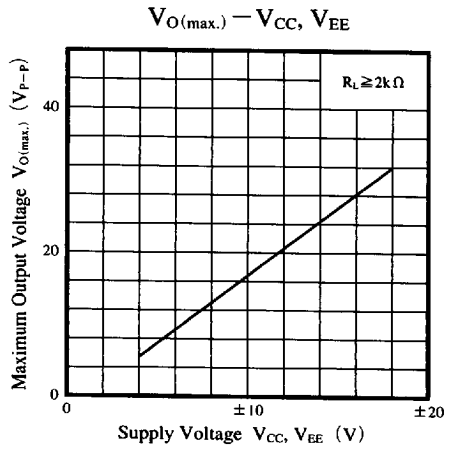
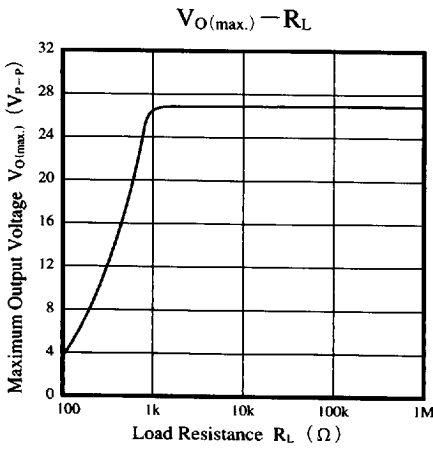
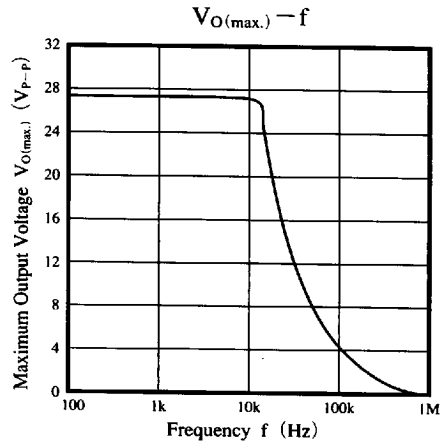
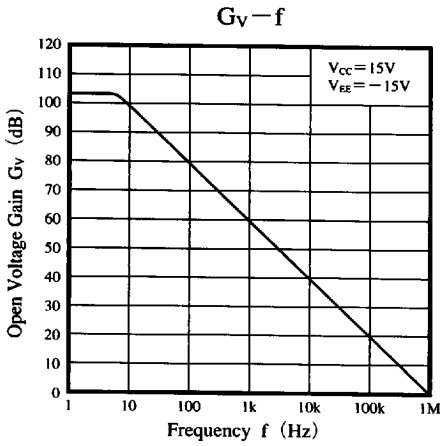

Operational Amplifiers

■ 6932852 0012389 841 ■

Panasonic

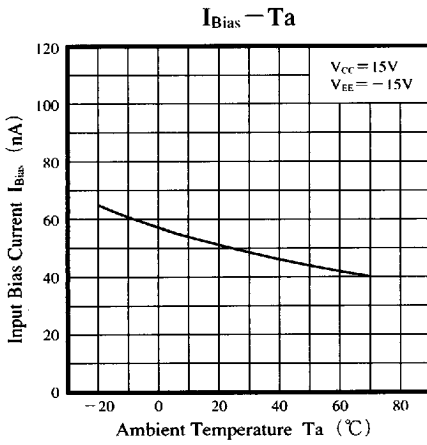
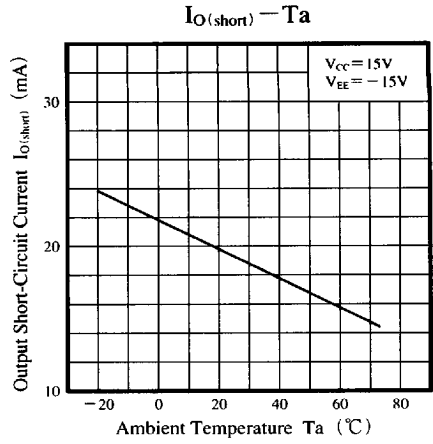
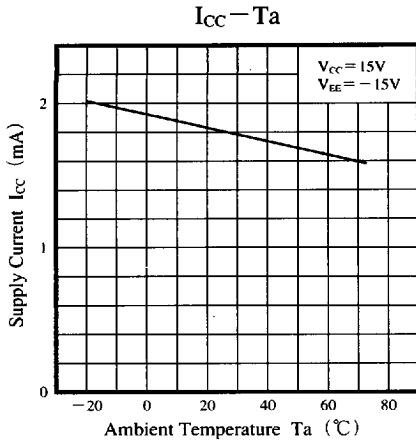

■ **Application Circuit**

Differential Amplifier

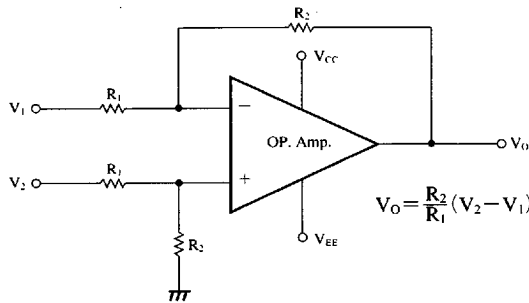

■ 6932852 0012390 563 ■

**Panasonic**