

APA06 SIP Non-isolated Series

Technical Reference Notes

3-5.5Vdc Input, 1.2Vdc - 3.3Vdc Output

20W DC-DC Converter

(Rev01)



Introduction

APA06 series power SIPs are non-isolated DC-DC modules with wide input voltage range featuring high efficiency up to 88% @ 2.5V_{out}, 89% @ 3.3V_{out}.

APA06 series comes in 3V to 5.5V input range and are capable of providing up to 20W of output power in a small size 2.5in.x0.55in.x0.33in.

The module uses a wide input range covering the old 3.3V input series and 5V input series, also provides 1.2V, 1.5V, 1.8V, 2.1V, 2.5V and 3.3V output voltage with 6A output current.

APA06 series converters feature high efficiency, high power density, wide operating environment temperature range, and easy installation.

The typical efficiencies are 89% for 3.3V_{out}, 88% for 2.5V_{out}, 86% for 2.1V_{out}, 83% for 1.8V_{out}, 81% for 1.5V_{out}, 78% for 1.2 V_{out}.

The operating environment temperature can reach 55°C with natural convection. With adjustable output, CNT function (positive or negative is optional), remote sense, OCP, short circuit protection and power good signal, the series are especially suitable for Telecom, Datacom, work station, servers and distributed power supply systems.

The APA06 series is designed to meet UL, TUV, and CSA certifications. UL has been approved.

Features

1. Wide input voltage: 3-5.5V
2. Wide operating environment temperature range (55°C derating with 200LFM)
3. High Efficiency: 89% typical @ 3.3V_{out}
4. High power density
5. Low output noise
6. Nonisolated output
7. Small size: 63.5mm x 14.0mm x 8.38mm (2.5 in. x 0.55 in. x 0.33in.)
8. Remote sense
9. Trim function: 84% - 116% V_o
10. Over-current and short circuit protection
11. Pin to pin enhanced replacement for IPD SIE05X.XLT

Applications

1. Distributed power architecture
2. Servers
3. Workstations
4. Desktop computers

Typical Application

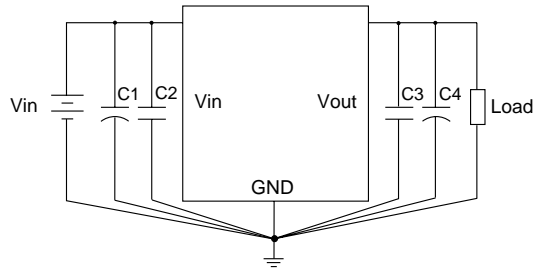

- C1 : Recommended 220 μ F Electrolytic Capacitor
- C2 : Recommended 2.2 μ F Ceramic Capacitor
- C3 : Recommended 2.2 μ F Ceramic Capacitor
- C4 : Recommended 220 μ F Tantalum Electrolytic Capacitor

Block Diagram

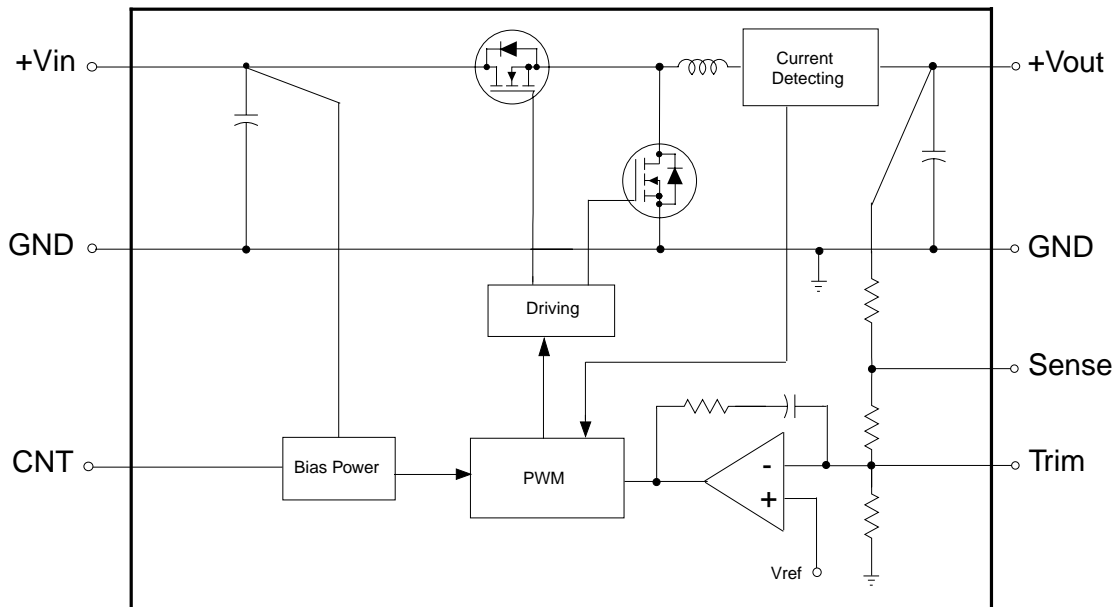

APA06 Non-Isolated Power SIPs
3V-5.5V Input, 1.2V-3.3V Output, 9-20W Output

Absolute Maximum Rating

Characteristic	Min	Typ	Max	Units	Notes
Input Voltage(continuous)			6	Vdc	
Input Voltage(peak/surge)			7	Vdc	100ms non-repetitive
Operating temperature	-25		55	°C	200LFM
storage temperature	-40		125	°C	

AVN20 Series Output Characteristics

Characteristic	Min	Typ	Max	Units	Notes
Power					
APA06K04(E-6)			7.2	W	
APA06M04(E-6)			9	W	
APA06Y04(E-6)			10.8	W	
APA06D04(E-6)			12.6	W	
APA06G05(E-6)			15	W	
APA06F05(E-6)			19.8	W	
Output Current			6	A	
Line Regulation			0.5	%Vo	Io=6A
Load Regulation			1	%Vo	Io=0~6A, Vin=5V
Efficiency					
APA06K04(E-6)	76	78		%	
APA06M04(E-6)	79	81		%	
APA06Y04(E-6)	81	83		%	
APA06D04(E-6)	84	86		%	
APA06G05(E-6)	86	88		%	
APA06F05(E-6)	87	89		%	
Dynamic Response					
25-50% load		50	70	mV	Ta=25°C, di/dt =1A/10µs
		100	200	µs	Ta=25°C, di/dt =1A/10µs
50-25% load		50	100	mV	Ta=25°C, di/dt =1A/10µs
		100	200	µs	Ta=25°C, di/dt =1A/10µs
Current Limit Threshold	6.6	9	10.8	A	
Output Setpoint Voltage	-1	0	+1	%Vo	Vin=5V, Io=6A
Trim Range	84		116	%Vo	
Sense Compensation		16		Vo%	
Temperature Coefficient			0.02	%Vo/°C	
Ripple (p-p)		25	50	mV	(0 to 20MHz BW)
Noise (p-p)			50	mV	(0 to 20MHz BW)
Switching Frequency		450		kHz	

APA06 Non-Isolated Power SIPs
3V-5.5V Input, 1.2V-3.3V Output, 9-20W Output

CNT Control

Characteristic	Min	Typ	Max	Units	Notes
High = OFF	2.4		12	Vdc	Open circuit = ON
Low = ON	-0.7		1.8	Vdc	
Control Current		1		mA	

General Specifications

Characteristic	Min	Typ	Max	Units	Notes
MTBF		7,000		k Hrs	Bellcore TR332, 25°C
Pin solder temperature			260	°C	wave solder < 10 s
Hand Soldering Time			5	s	iron temperature 425°C
Weight			7.5	grams	

Ordering Information

Model Number	Input Voltage	Rated Input Current	Output Voltage	Rated Output Current	Efficiency typ	
APA06K04 (E-6)	3-5.5V	3.2A	1.5V	6A	78	
APA06M04 (E-6)	3-5.5V	3.8A	1.5V	6A	81	
APA06Y04 (E-6)	3-5.5V	4.4A	1.8V	6A	83	
APA06D04 (E-6)	3-5.5V	5.0A	2.1V	6A	86	
APA06G05 (E-6)	4.5-5.5V	3.9A	2.5V	6A	88	
APA06F05 (E-6)	4.5-5.5V	5.1A	3.3V	6A	89	

Input Characteristics

Characteristic	Min	Typ	Max	Units	Notes
Input Voltage Range	3	4.5	5.5	Vdc	04SXVX
	4.5	5	5.5	Vdc	05SXVX
Input Reflected Current (p-p)		4	6	%lin	
Shortcircuit Current			0.1	A	

Efficiency Characteristic Curves (at 25°C)

Typical Efficiency APA06K04(E-6)

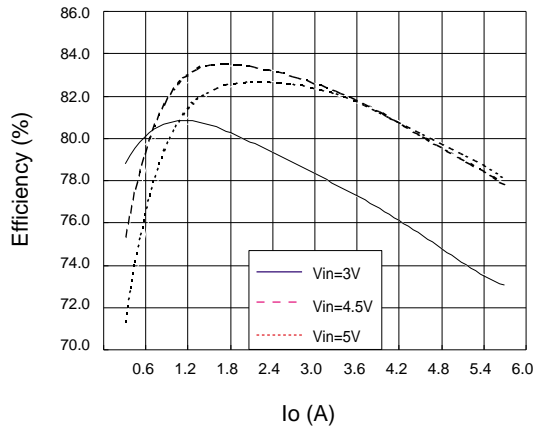

Typical Efficiency APA06M0(E-6)

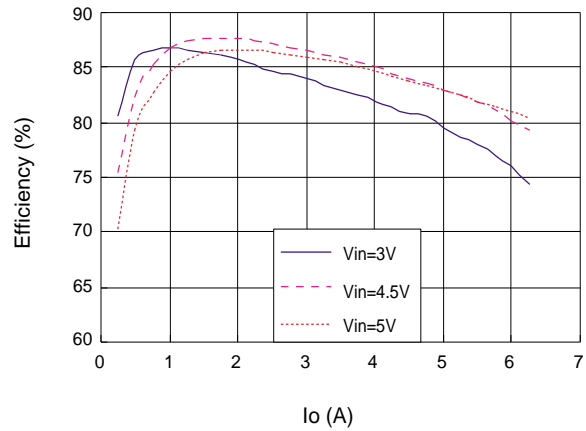

Typical Efficiency APA06Y04(E-6)

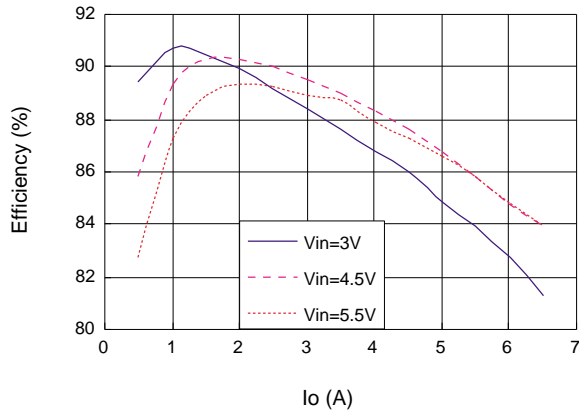

Typical Efficiency APA06D04(E-6)

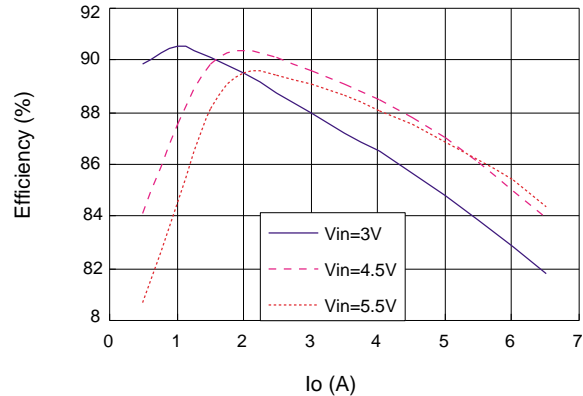

Typical Efficiency APA06G05(E-6)

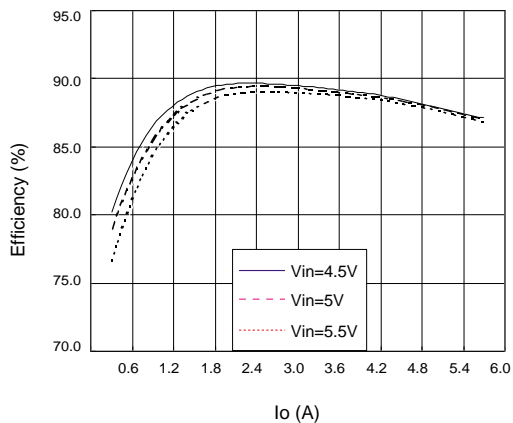

Typical Efficiency APA06F05(E-6)

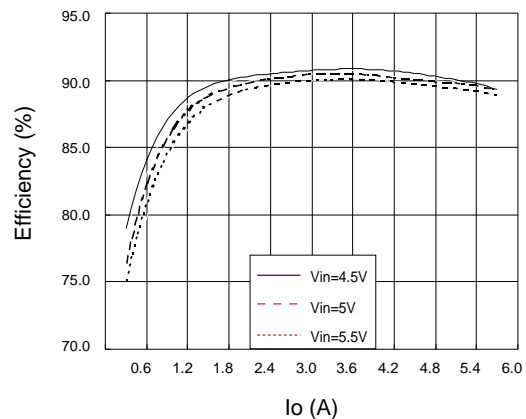

Characteristic Curves (at 25°C)

The waveform of Power OK signal rising, APA06M04(E-6)

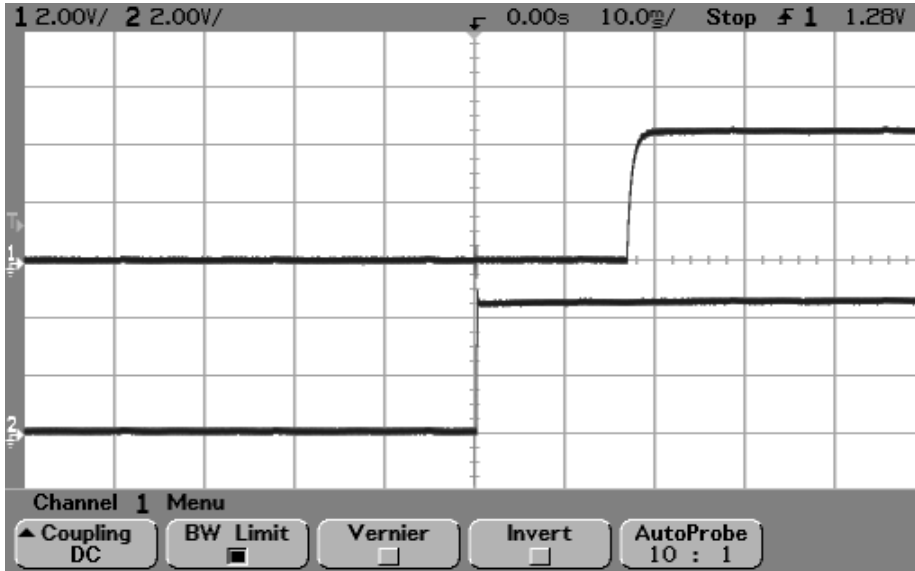

(condition:
 Vin=4.5V,
 Vout=1.5V, Iout=6A,
 Temp=25°C,
 Channel 1-Power
 OK,
 Channel 2- Input
 voltage)

Typical Transient Response Load, 50%-100%-50%Iomax, APA06M04(E-6)

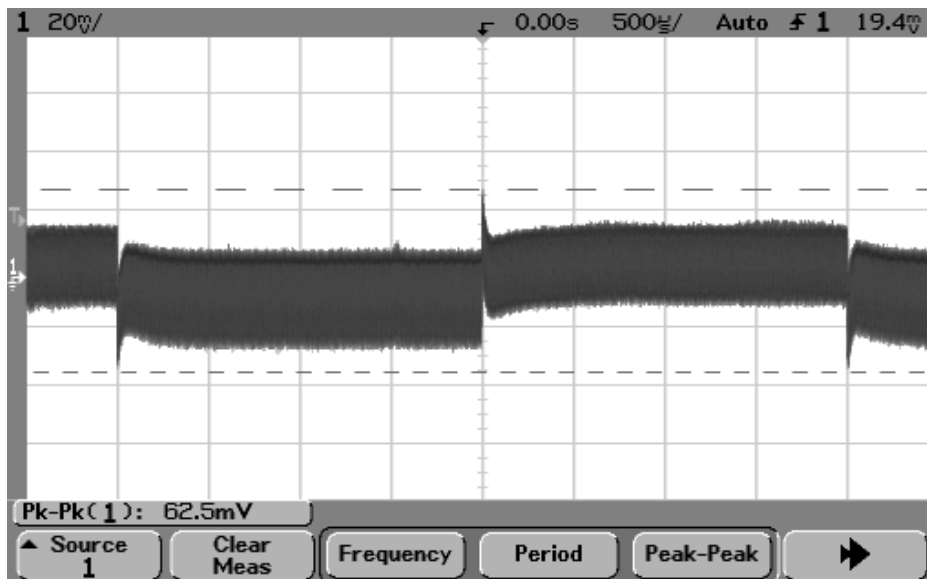

(condition:
 Vin=4.5V,
 Vout=1.5V, Iout=6A,
 Temp=25°C)

Characteristic Curves (at 25°C)

Typical Start-Up at Rated load, APA06M04(E-6)

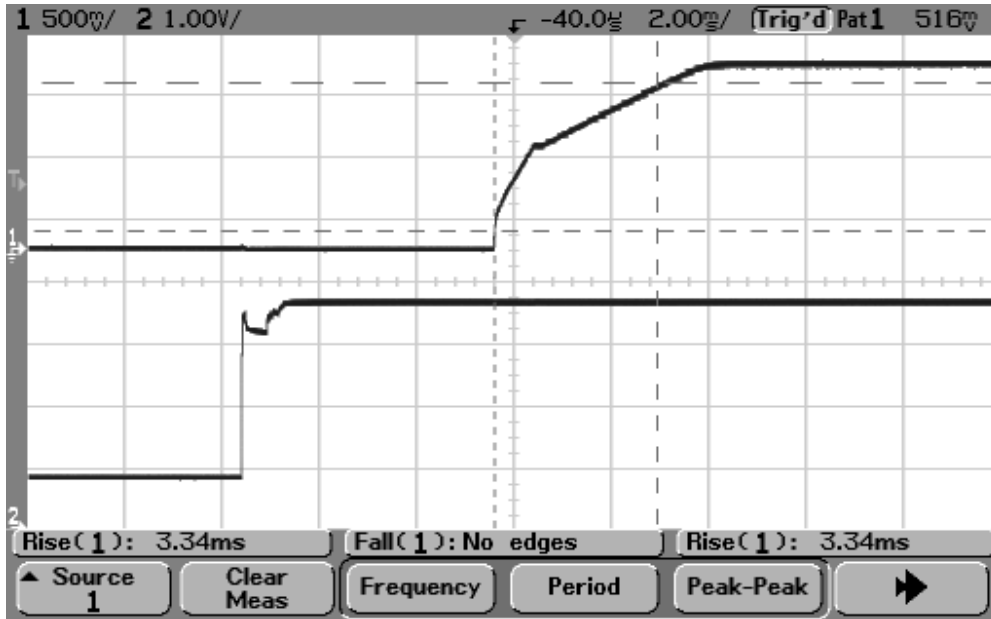

(condition:
 Vin=4.5V,
 Vout=1.5V, Iout=6A,
 Temp=25°C,
 Channel 1-Output
 Voltage,
 Channel 2- Input
 Voltage)

APA06 Series Derating Curves (Po-Ta)

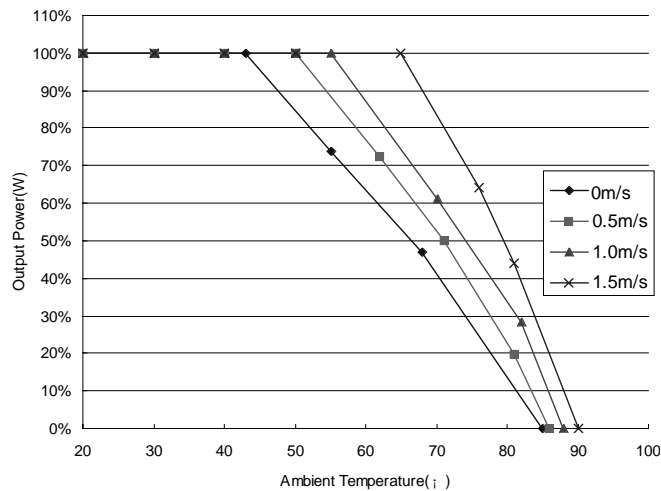

Characteristic Curves (at 25°C)

Typical Shut-Down at Rated load, APA06M04(E-6)

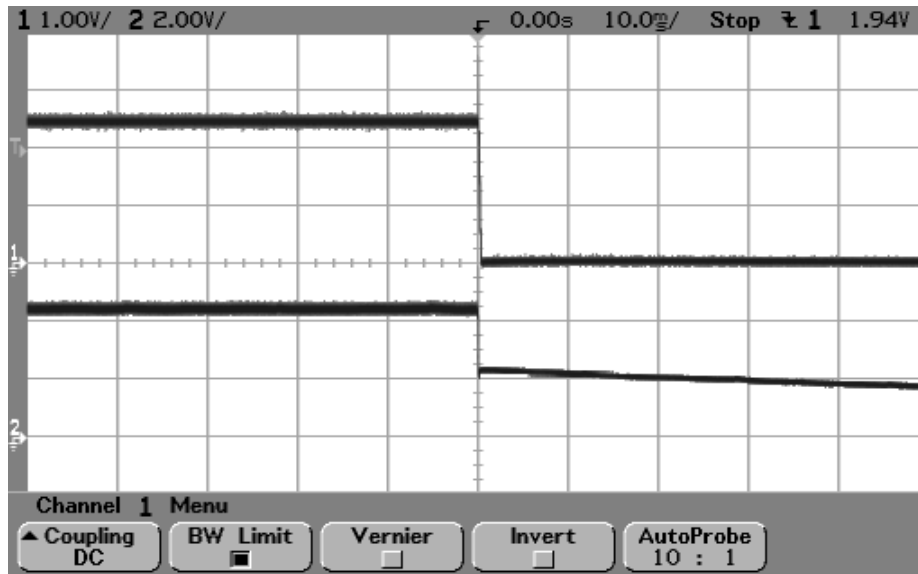

(condition: $V_{in}=4.5V$,
 $V_{out}=1.5V$, $I_{out}=6A$,
 $Temp=25^{\circ}C$, Channel
 1-Output Voltage,
 Channel 2- Input
 Voltage)

Typical Output Ripple and Noise, APA06M04(E-6)

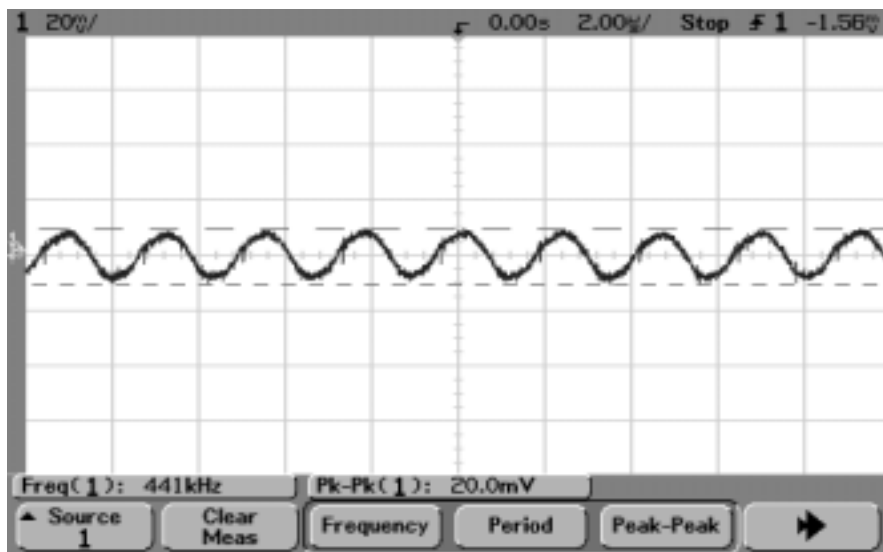

(condition: $V_{in}=4.5V$,
 $V_{out}=1.5V$, $I_{out}=3A$,
 $Temp=25^{\circ}C$)

Input Characteristics Output Characteristics

The APA06 power module has no internal fuse. An external fuse must always be employed! To meet international safety requirements, an input line fuse should be used. Input wires and copper coil must be capable of conducting a current of 1.5 times the value of the fuse. If one of the input lines is connected to chassis ground, then the fuse must be placed in the other input line.

A fuse with ratings of 15A is recommended for 2.5V and 3.3V output, and 10A for APA06 other products.

CNT Function

The APA06 provides CNT function allowing the user to turn the output on and off using an external circuit such as figure 1 and figure 2. The control voltage-threshold is: 1.8V. For negative control(negative logic **N** or positive logic **P** are optional), applying a voltage less than 1.8V to the CNT pin will enable the output, while applying a voltage greater than 2.4V will disable it. **If not using CNT feature, leave the CNT pin open.** The maximum voltage that can be applied to the control pin is 12 volts.

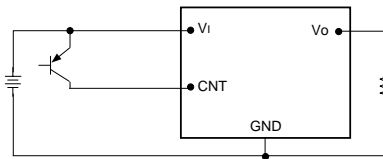

Fig.1 Transistor CNT Control

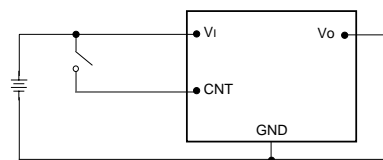

Fig.2 Simple CNT Control

Remote Sensing

When the load can not be placed close to converter output pin, voltage drop will occur in distribution. This voltage drop can be compensated using sense lead. As shown in figure 3, connecting sense pin close to the load, when the load changes, the module will automatically adjust the real output to maintain the constant voltage on the load.

If not using the remote sense pin, leave it open.

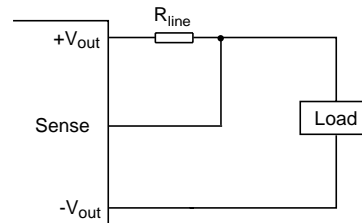

Fig.3 Sense Connection

Output Trimming

Output can be externally trimmed by using either method shown in figure 4.

Users can increase or decrease the output voltage set point of a module by connecting an external resistor between the TRIM pin and either the +Vout or GND pins. The trim resistor should be positioned close to the module. **If not using the trim feature, leave the TRIM pin open.**

Trimming up or down by more than 16% of the nominal output may cause the converter to work improperly.

The trim formula for different output voltage are shown in figure 4 next page.

APA06 Non-Isolated Power SIPs
3V-5.5V Input, 1.2V-3.3V Output, 9-20W Output

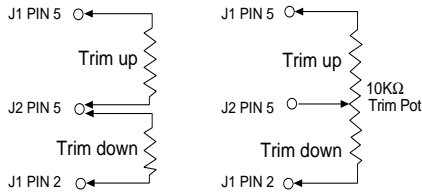

1.2Vout:

$$R_{\text{trim up}} = \frac{7.18 \times V_{O \text{ up}} - 25.58}{11.78 - 9.78 \times V_{O \text{ up}}}$$

$$R_{\text{trim down}} = \frac{25.38 \times V_{O \text{ down}} - 25.58}{11.78 - 9.78 \times V_{O \text{ down}}}$$

1.5Vout:

$$R_{\text{trim up}} = \frac{136.9 - 54.75 \times V_{O \text{ up}}}{18.65 \times V_{O \text{ up}} - 27.88}$$

$$R_{\text{trim down}} = \frac{210 \times V_{O \text{ down}} - 262.51}{55 - 37 \times V_{O \text{ down}}}$$

1.8Vout:

$$R_{\text{trim up}} = \frac{6.20 \times (8.25 - 2.7 \times V_{O \text{ up}})}{8.9 \times V_{O \text{ up}} - 16.00}$$

$$R_{\text{trim down}} = \frac{135.04 \times V_{O \text{ down}} - 168.795}{52.8 - 29.37 \times V_{O \text{ down}}}$$

2.1Vout:

$$R_{\text{trim up}} = \frac{3.01 \times (4.6 - V_{O \text{ up}})}{4.01 \times V_{O \text{ up}} - 8.39}$$

$$R_{\text{trim down}} = \frac{41.21 \times V_{O \text{ down}} - 51.51}{31.03 - 14.84 \times V_{O \text{ down}}}$$

2.5Vout:

$$R_{\text{trim up}} = \frac{1.40 \times V_{O \text{ up}} - 9.55}{6.78 - 2.72 \times V_{O \text{ up}}}$$

$$R_{\text{trim down}} = \frac{7.37 \times V_{O \text{ down}} - 9.55}{6.78 - 2.72 \times V_{O \text{ down}}}$$

3.3Vout:

$$R_{\text{trim up}} = \frac{0.73 \times V_{O \text{ up}} - 5.89}{5.72 - 1.73 \times V_{O \text{ up}}}$$

$$R_{\text{trim down}} = \frac{4.43 \times V_{O \text{ down}} - 5.89}{5.72 - 1.73 \times V_{O \text{ down}}}$$

Where: $R_{\text{trim up}}$ is trimming up resistance,
 $R_{\text{trim down}}$ is trimming down resistance,
 $V_{O \text{ up}}$ is trim up voltage,
 $V_{O \text{ down}}$ is trim down voltage,
 R is in k Ω .

Fig.4 Output Voltage Set-point Adjustment

Output Over-Current Protection

APA06 series DC-DC converters feature current limiting with a threshold is between 8.4A and 10.8A. These modules can tolerate short circuit conditions (continuously or transient). When the overcurrent condition is removed, the converter will automatically restart.

Power Good signal

	min	max
High-level	2.1V	
Low-level		1.05V

Inner resistance = 5.1k Ω .

Parallel application

APA06 series DC-DC converters can be used in parallel (at most two modules). You can use diode (or not) in output circuit. The parallel two power module can (total) output the largest current 7.5~8A in a long time. If the load is over 8A, the output will be in hiccup over-current protection. The application circuit is shown as in Figure 5.

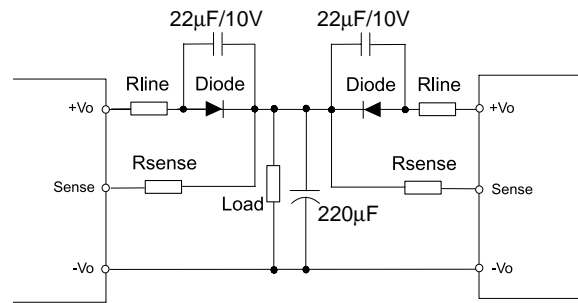

Fig.5 APA06 Parallel Application

The load is between 6A and 8A, a resistance **Rsense** which is 1 Ω is needed for current sharing. If you want to use our APA06 series power module in parallel mode, please advise the factory for details.

Safety Considerations

For safety-agency approval of the system in which the power module is used, the power module must be installed in compliance with the spacing and separation requirements of the end-use safety agency standard, i.e., UL1950, CSA C22.2 No. 950-95, and VDE 0805 (EN60950, IEC950).

For the module's output to be considered meeting the requirements of safety extra-low voltage (SELV), one of the following must be true:

1. All inputs are SELV and floating, with the output also floating.
2. All inputs are SELV and grounded, with the

output also grounded.

3. Any non-SELV input must be provided with reinforced from any other hazardous voltages, including the ac mains, and must have a SELV reliability test performed on it in combination with the converters. Inputs must meet SELV requirements.

If the input meets extra-low voltage (ELV) requirements, then the converter's output is considered ELV.

The input to these units is to be provided with a maximum 10A normal blow fuse in the ungrounded lead.

APA06G05(E-6) and APA6F05(E-6) need 15A fuse.

Mechanical Considerations

Thermal Performance

APA06 series will derate at 55°C under the condition of 200LFM. In order to maintain efficient heat dissipation, the converters should be mounted parallel with the air-flow direction.

Soldering

APA06 series converters are compatible with standard wave soldering techniques. When wave soldering, the converter pins should be preheated for 20-30 seconds at 110°C, and wave soldered at 260°C for less than 10 seconds.

When hand soldering, the iron temperature should be maintained at 425°C and applied to the converter pins for less than 5 seconds. Longer exposure can cause internal damage to the converter. Cleaning can be performed with cleaning solvent IPA or with water.

Recommended Hole Pattern

Dimensions are in millimeters (inches). Component-side footprint.

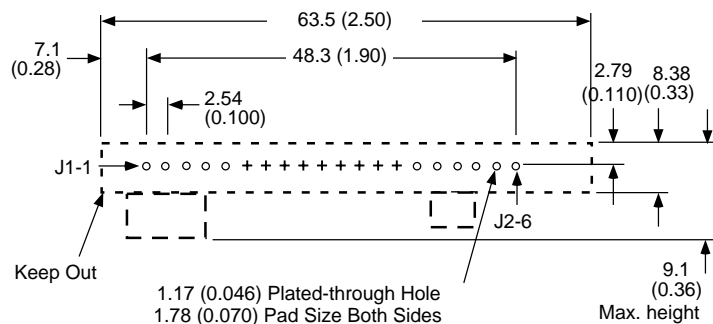
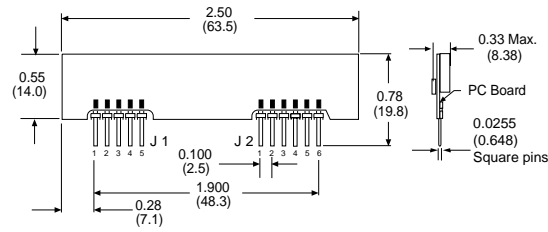

Fig.6 Recommended Hole Pattern

Mechanical Chart (Figure 7-9 next page)

APA06 Non-Isolated Power SIPs
3V-5.5V Input, 1.2V-3.3V Output, 9-20W Output



J1-1	+Vout	J2-1	GND	Tolerances:	
J1-2	+Vout	J2-2	+Vin	Inches	Millimeters
J1-3	Sense	J2-3	+Vin	.xx ±0.020	.x ±0.5
J1-4	+Vout	J2-4	Power Good	.xxx ±0.010	.xx ±0.25
J1-5	GND	J2-5	Trim	Pins	
		J2-6	CNT	±0.02	±0.5

Fig.7 APA06 Series Mechanical Chart

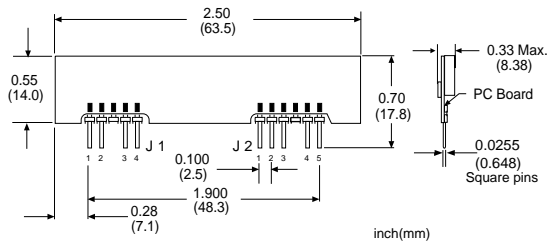

inch(mm)

Pin	Function	Pin	Function	Tolerances:	
J1-1	+Vout	J2-1	GND	Inches	Millimeters
J1-2	+Vout	J2-2	+Vin	.xx ±0.020	.x ±0.5
J1-3	+Vout	J2-3	+Vin	.xxx ±0.010	.xx ±0.25
J1-4	GND	J2-4	Trim	Pins	
		J2-5	CNT	±0.02	±0.5

Fig.8 APA06 Basic Function Series Mechanical Chart

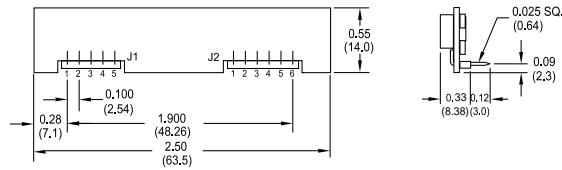

J1-1	+Vout	J2-1	GND	Tolerances:	
J1-2	+Vout	J2-2	+Vin	Inches	Millimeters
J1-3	Sense	J2-3	+Vin	.xx ±0.020	.x ±0.5
J1-4	+Vout	J2-4	Power Good	.xxx ±0.010	.xx ±0.25
J1-5	GND	J2-5	Trim	Pins	
		J2-6	CNT	±0.02	±0.5

Fig.9 APA06 Series Right Angle Pins Mechanical Chart

PART NUMBER DESCRIPTION

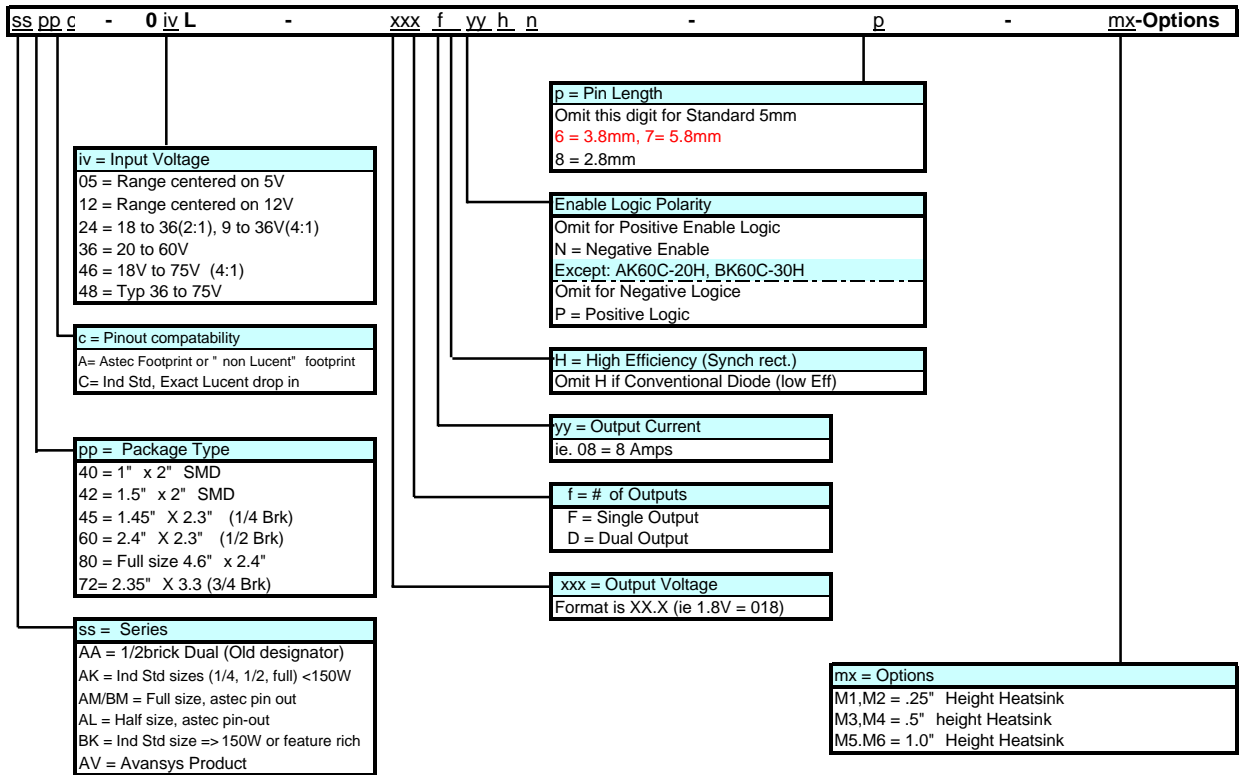

Note: For some products, they may not conform with the PART NUMBER DESCRIPTION above absolutely.

NEW PART NUMBER DESCRIPTION

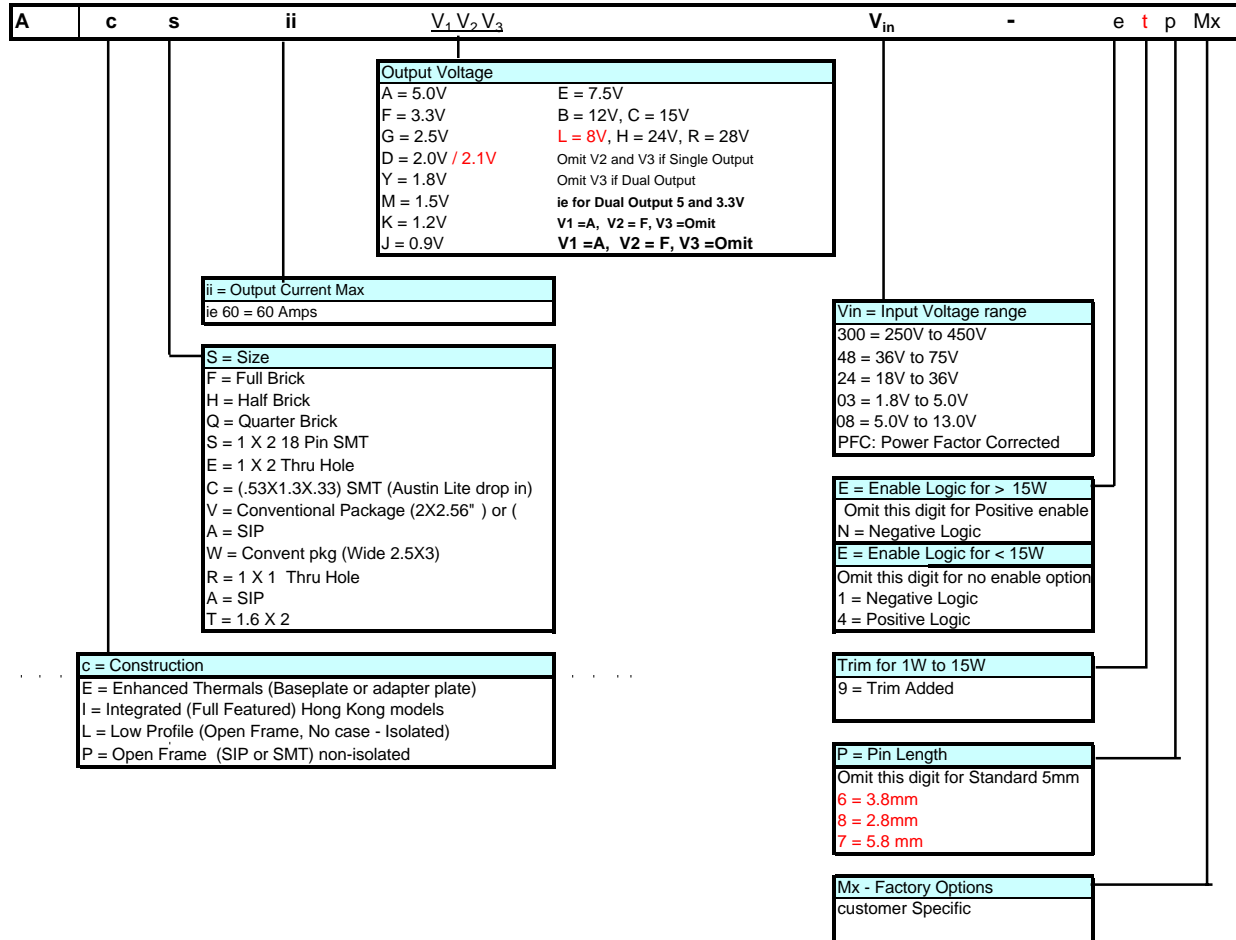

Note: For some products, they may not conform with the NEW PART NUMBER DESCRIPTION above absolutely.