

70A, 30V, 0.010 Ohm, N-Channel Power MOSFETs

These N-Channel power MOSFETs are manufactured using the MegaFET process. This process, which uses feature sizes approaching those of LSI integrated circuits gives optimum utilization of silicon, resulting in outstanding performance. They were designed for use in applications such as switching regulators, switching converters, motor drivers, and relay drivers. These transistors can be operated directly from integrated circuits.

Formerly developmental type TA49025.

Ordering Information

PART NUMBER	PACKAGE	BRAND
RFP70N03	TO-220AB	RFP70N03
RF1S70N03SM	TO-263AB	F1S70N03

NOTE: When ordering, use the entire part number. Add the suffix 9A to obtain the TO-263AB variant in tape and reel, e.g., RF1S70N03SM9A

Features

- 70A, 30V
- $r_{DS(ON)} = 0.010\Omega$
- Temperature Compensating PSPICE® Model
- Peak Current vs Pulse Width Curve
- UIS Rating Curve (Single Pulse)
- 175°C Operating Temperature
- Related Literature
 - TB334 "Guidelines for Soldering Surface Mount Components to PC Boards"

Symbol

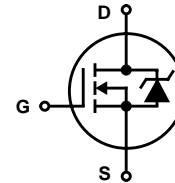

Packaging

JEDEC TO-220AB

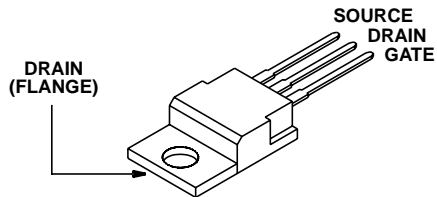

JEDEC TO-263AB

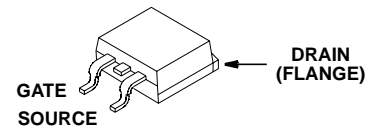

RFP70N03, RF1S70N03SM

Absolute Maximum Ratings $T_C = 25^\circ\text{C}$, Unless Otherwise Specified

			UNITS
Drain to Source Voltage (Note 1)	V_{DSS}	30	V
Drain to Gate Voltage ($R_{GS} = 20k\Omega$) (Note 1)	V_{DGR}	30	V
Gate to Source Voltage	V_{GS}	± 20	V
Drain Current			
Continuous (Figure 2)	I_D	70	A
Pulsed Drain Current	I_{DM}	200	A
Pulsed Avalanche Rating	E_{AS}	Figures 5, 13, 14	
Power Dissipation	P_D	150	W
Derate Above 25°C		1.0	$\text{W}/^\circ\text{C}$
Operating and Storage Temperature	T_J, T_{STG}	-55 to 175	$^\circ\text{C}$
Maximum Temperature for Soldering			
Leads at 0.063in (1.6mm) from case for 10s	T_L	300	$^\circ\text{C}$
Package Body for 10s, see Techbrief 334	T_{pkg}	260	$^\circ\text{C}$

CAUTION: Stresses above those listed in "Absolute Maximum Ratings" may cause permanent damage to the device. This is a stress only rating and operation of the device at these or any other conditions above those indicated in the operational sections of this specification is not implied.

NOTE:

1. $T_J = 25^\circ\text{C}$ to 150°C .

Electrical Specifications $T_C = 25^\circ\text{C}$, Unless Otherwise Specified

PARAMETER	SYMBOL	TEST CONDITIONS	MIN	TYP	MAX	UNITS
Drain to Source Breakdown Voltage	BV_{DSS}	$I_D = 250\mu\text{A}, V_{GS} = 0\text{V}$ (Figure 10)	30	-	-	V
Gate to Source Threshold Voltage	$V_{GS(TH)}$	$V_{GS} = V_{DS}, I_D = 250\mu\text{A}$ (Figure 9)	2	-	4	V
Zero Gate Voltage Drain Current	I_{DSS}	$V_{DS} = 30\text{V}, V_{GS} = 0\text{V}$	-	-	1	μA
		$V_{DS} = 30\text{V}, V_{GS} = 0\text{V}, T_C = 150^\circ\text{C}$	-	-	50	μA
Gate to Source Leakage Current	I_{GSS}	$V_{GS} = \pm 20\text{V}$	-	-	100	nA
Drain to Source On Resistance	$r_{DS(ON)}$	$I_D = 70\text{A}, V_{GS} = 10\text{V}$ (Figure 8)	-	-	0.010	Ω
Turn-On Time	t_{ON}	$V_{DD} = 15\text{V}, I_D \cong 70\text{A},$ $R_L = 0.214\Omega, V_{GS} = 10\text{V},$ $R_{GS} = 2.5\Omega$	-	-	80	ns
Turn-On Delay Time	$t_{d(ON)}$		-	20	-	ns
Rise Time	t_r		-	20	-	ns
Turn-Off Delay Time	$t_{d(OFF)}$		-	40	-	ns
Fall Time	t_f		-	25	-	ns
Turn-Off Time	t_{OFF}		-	-	125	ns
Total Gate Charge	$Q_{g(TOT)}$	$V_{GS} = 0\text{V}$ to 20V	-	215	260	nC
Gate Charge at 10V	$Q_{g(10)}$	$V_{GS} = 0\text{V}$ to 10V				
Threshold Gate Charge	$Q_{g(TH)}$	$V_{GS} = 0\text{V}$ to 2V				
Input Capacitance	C_{ISS}	$V_{DS} = 25\text{V}, V_{GS} = 0\text{V},$ $f = 1\text{MHz}$ (Figure 11)	-	3300	-	pF
Output Capacitance	C_{OSS}		-	1750	-	pF
Reverse Transfer Capacitance	C_{RSS}		-	750	-	pF
Thermal Resistance Junction to Case	$R_{\theta JC}$	(Figure 3)	-	-	1.0	$^\circ\text{C}/\text{W}$
Thermal Resistance Junction to Ambient	$R_{\theta JA}$	TO-220, TO-263	-	-	62	$^\circ\text{C}/\text{W}$

Source to Drain Diode Specifications

PARAMETER	SYMBOL	TEST CONDITIONS	MIN	TYP	MAX	UNITS
Source to Drain Diode Voltage	V_{SD}	$I_{SD} = 70\text{A}$	-	-	1.5	V
Reverse Recovery Time	t_{rr}	$I_{SD} = 70\text{A}, dI_{SD}/dt = 100\text{A}/\mu\text{s}$	-	-	125	ns

Typical Performance Curves

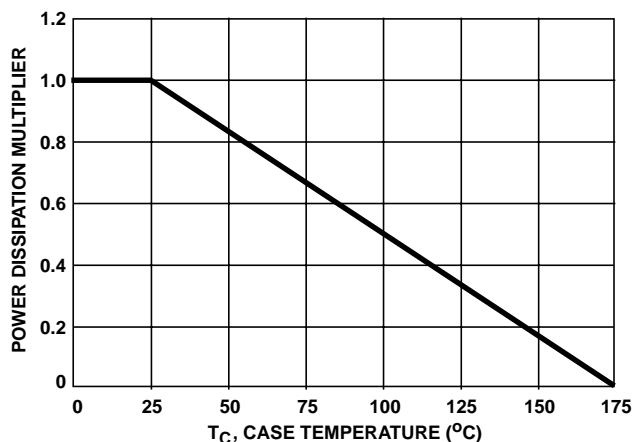

FIGURE 1. NORMALIZED POWER DISSIPATION vs CASE TEMPERATURE

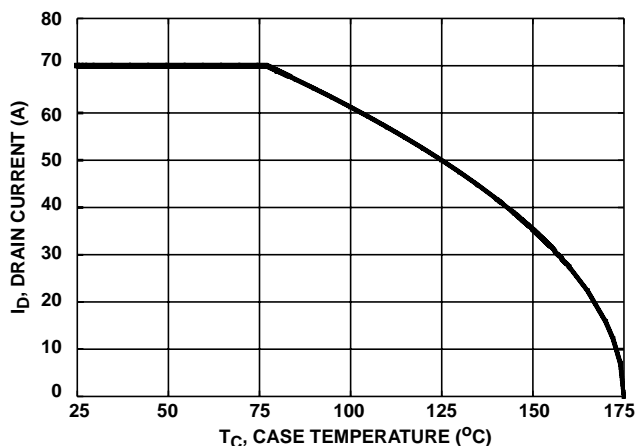

FIGURE 2. MAXIMUM CONTINUOUS DRAIN CURRENT vs CASE TEMPERATURE

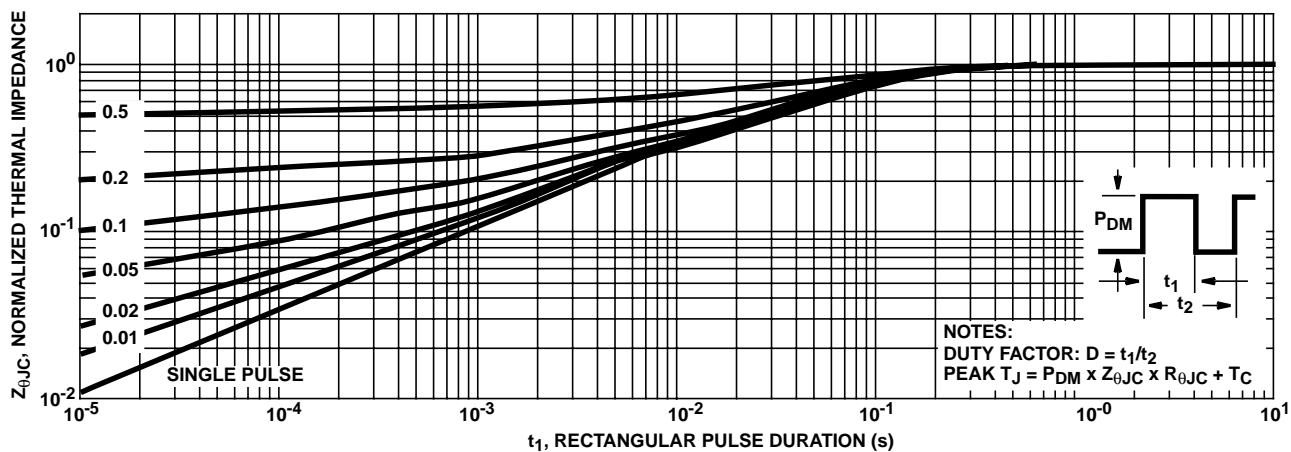

FIGURE 3. NORMALIZED MAXIMUM TRANSIENT THERMAL IMPEDANCE

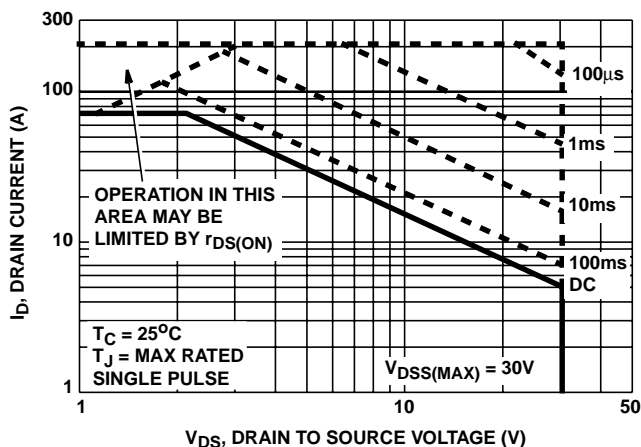
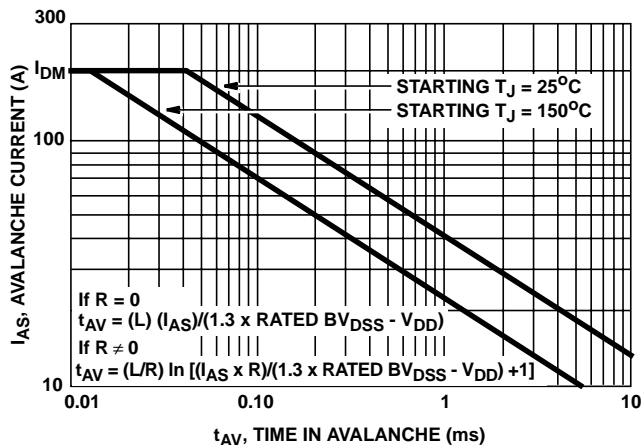

FIGURE 4. FORWARD BIAS SAFE OPERATING AREA



NOTE: Refer to Intersil Application Notes AN9321 and AN9322.

FIGURE 5. UNCLAMPED INDUCTIVE SWITCHING CAPABILITY

Typical Performance Curves (Continued)

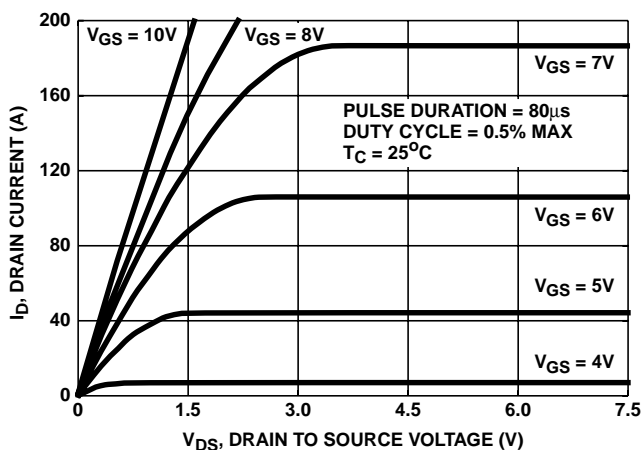

FIGURE 6. SATURATION CHARACTERISTICS

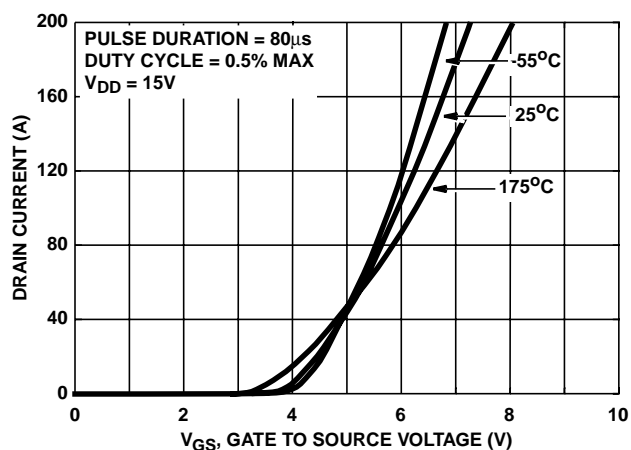

FIGURE 7. TRANSFER CHARACTERISTICS

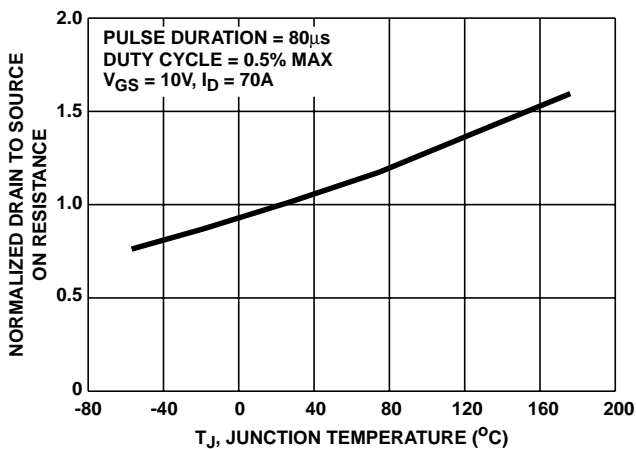

FIGURE 8. NORMALIZED DRAIN TO SOURCE ON RESISTANCE vs JUNCTION TEMPERATURE

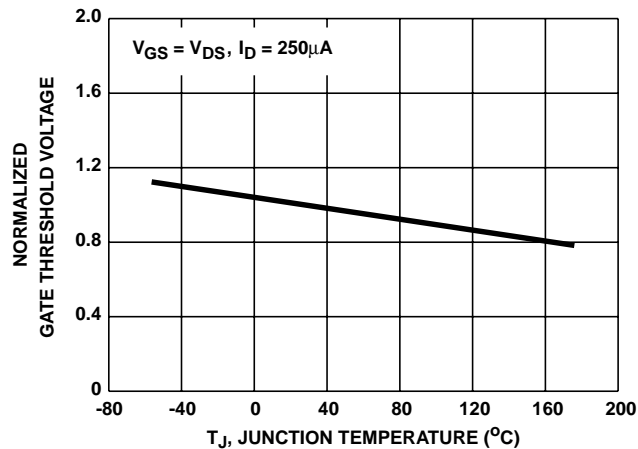

FIGURE 9. NORMALIZED GATE THRESHOLD VOLTAGE vs JUNCTION TEMPERATURE

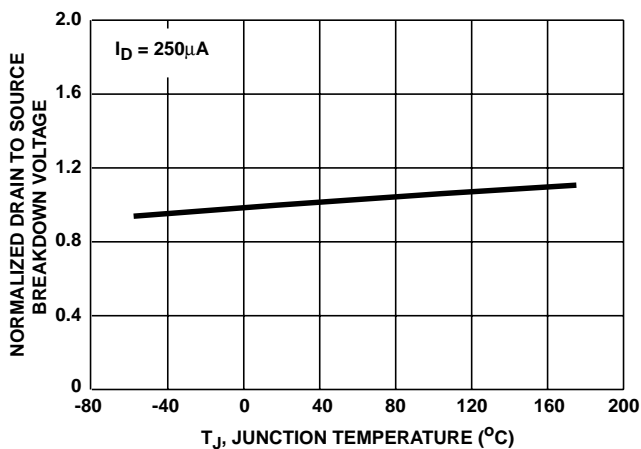

FIGURE 10. NORMALIZED DRAIN TO SOURCE BREAKDOWN VOLTAGE vs JUNCTION TEMPERATURE

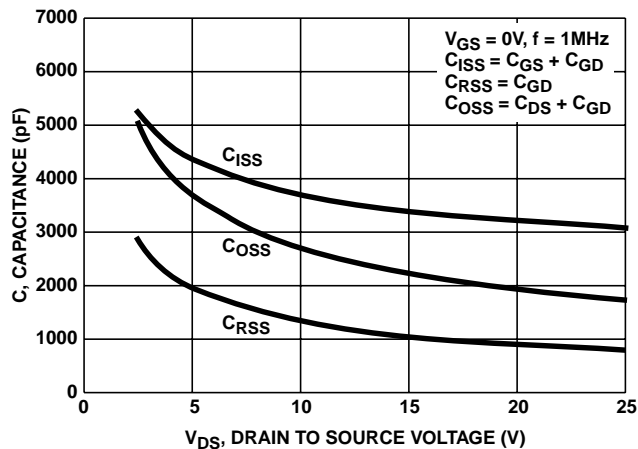
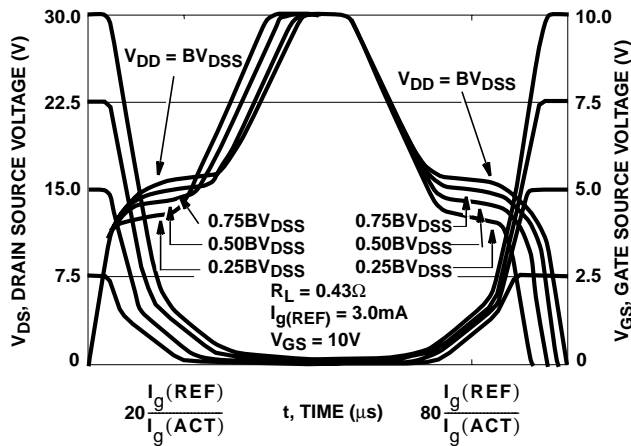

FIGURE 11. CAPACITANCE vs DRAIN TO SOURCE VOLTAGE

Typical Performance Curves (Continued)



NOTE: Refer to Intersil Application Notes AN7254 and AN7260.

FIGURE 12. GATE CHARGE WAVEFORMS FOR CONSTANT GATE CURRENT

Test Circuits and Waveforms

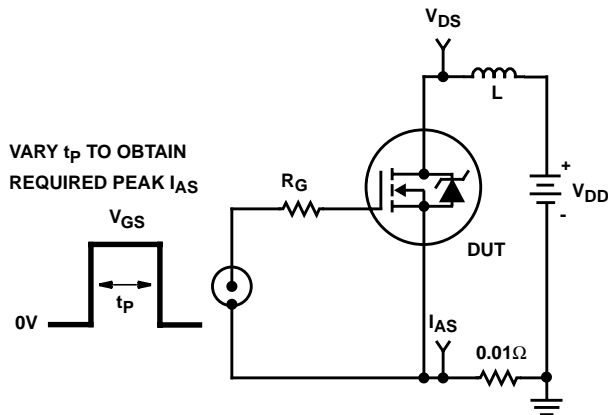

FIGURE 13. UNCLAMPED ENERGY TEST CIRCUIT

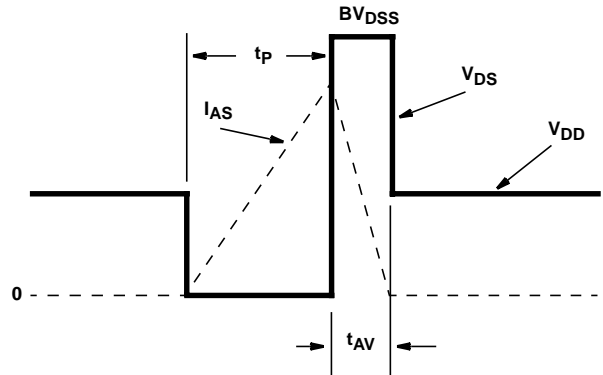

FIGURE 14. UNCLAMPED ENERGY WAVEFORMS

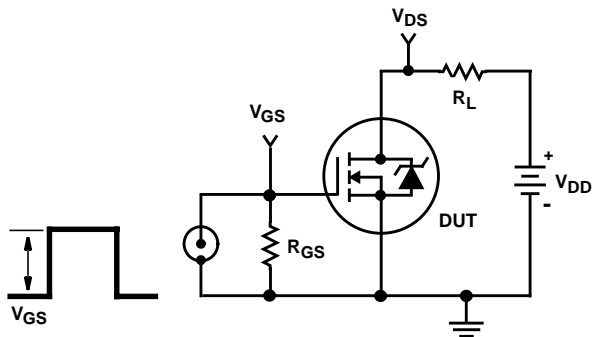

FIGURE 15. SWITCHING TIME TEST CIRCUIT

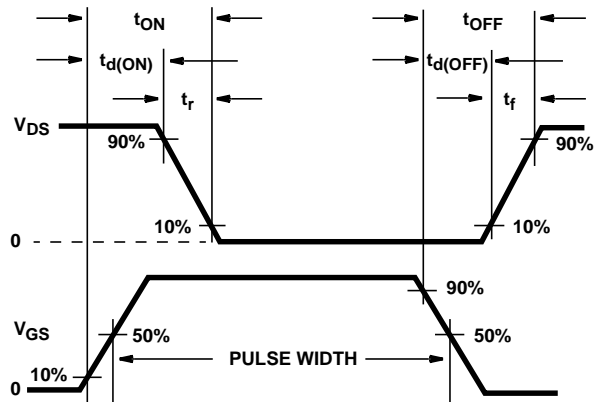

FIGURE 16. SWITCHING WAVEFORMS

Test Circuits and Waveforms (Continued)

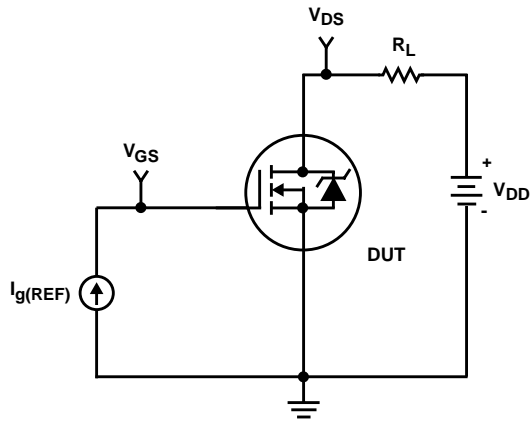

FIGURE 17. GATE CHARGE TEST CIRCUIT

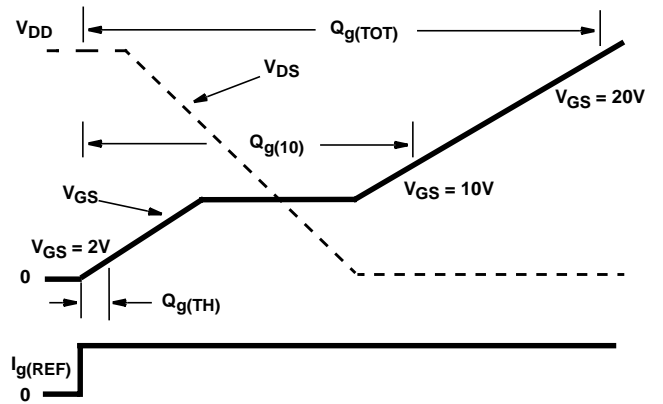

FIGURE 18. GATE CHARGE WAVEFORM

PSPICE Electrical Model

.SUBCKT RFP70N03 2 1 3 ; rev 9/16/92
 *NOM TEMP = 25°C

CA 12 8 6.09e-9
 CB 15 14 6.05e-9
 CIN 6 8 3.40e-9

DBODY 7 5 DBDMOD
 DBREAK 5 11 DBKMOD
 DPLCAP 10 5 DPLCAPMOD

EBREAK 11 7 17 18 35.4
 EDS 14 8 5 8 1
 EGS 13 8 6 8 1
 ESG 6 10 6 8 1
 EVTO 20 6 18 8 1

IT 8 17 1

LDRAIN 2 5 1e-9
 LGATE 1 9 3.10e-9
 LSOURCE 3 7 1.82e-9

MOS1 16 6 8 8 MOSMOD M=0.99
 MOS2 16 21 8 8 MOSMOD M=0.01

RBREAK 17 18 RBKMOD 1
 RDRAIN 5 16 RDSMOD 30.7e-6
 RGATE 9 20 0.890
 RIN 6 8 1e9
 RSOURCE 8 7 RDSMOD 3.92e-3
 RVTO 18 19 RVTOMOD 1

S1A 6 12 13 8 S1AMOD
 S1B 13 12 13 8 S1BMOD
 S2A 6 15 14 13 S2AMOD
 S2B 13 15 14 13 S2BMOD

VBAT 8 19 DC 1
 VTO 21 6 0.605

.MODEL DBDMOD D (IS=7.91e-12 RS=3.87e-3 TRS1=2.71e-3 TRS2=2.50e-7 CJO=4.84e-9 TT=4.51e-8)
 .MODEL DBKMOD D (RS=3.9e-2 TRS1=1.05e-4 TRS2=3.11e-5)
 .MODEL DPLCAPMOD D (CJO=4.8e-9 IS=1e-30 N=10)
 .MODEL MOSMOD NMOS (VTO=3.46 KP=47 IS=1e-30 N=10 TOX=1 L=1u W=1u)
 .MODEL RBKMOD RES (TC1=8.46e-4 TC2=-8.48e-7)
 .MODEL RDSMOD RES (TC1=2.23e-3 TC2=6.56e-6)
 .MODEL RVTOMOD RES (TC1=-3.29e-3 TC2=3.49e-7)
 .MODEL S1AMOD VSWITCH (RON=1e-5 ROFF=0.1 VON=-8.35 VOFF=-6.35)
 .MODEL S1BMOD VSWITCH (RON=1e-5 ROFF=0.1 VON=-6.35 VOFF=-8.35)
 .MODEL S2AMOD VSWITCH (RON=1e-5 ROFF=0.1 VON=-2.0 VOFF=3.0)
 .MODEL S2BMOD VSWITCH (RON=1e-5 ROFF=0.1 VON=3.0 VOFF=-2.0)

.ENDS

NOTE: For further discussion of the PSPICE model consult **A New PSPICE Sub-circuit for the Power MOSFET Featuring Global Temperature Options**; written by William J. Hepp and C. Frank Wheatley.

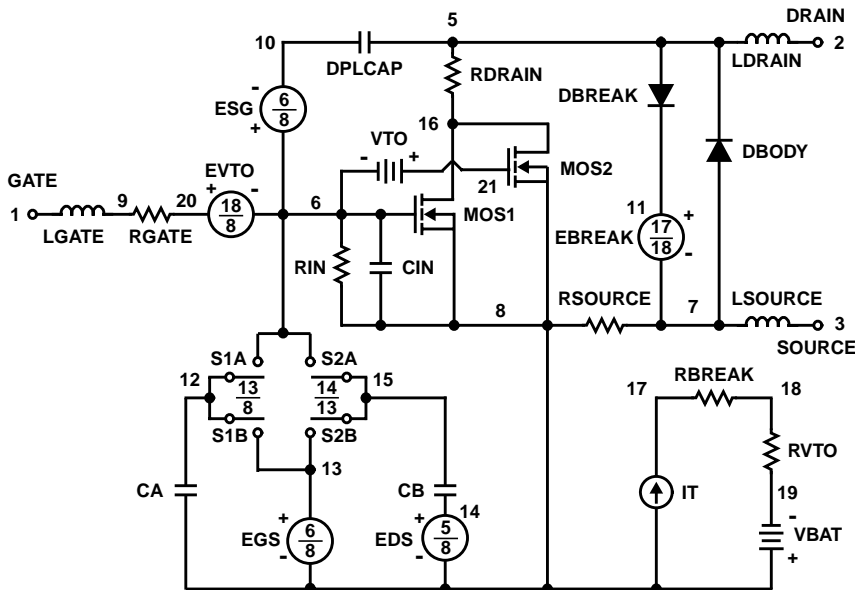

All Intersil semiconductor products are manufactured, assembled and tested under **ISO9000** quality systems certification.

Intersil semiconductor products are sold by description only. Intersil Corporation reserves the right to make changes in circuit design and/or specifications at any time without notice. Accordingly, the reader is cautioned to verify that data sheets are current before placing orders. Information furnished by Intersil is believed to be accurate and reliable. However, no responsibility is assumed by Intersil or its subsidiaries for its use; nor for any infringements of patents or other rights of third parties which may result from its use. No license is granted by implication or otherwise under any patent or patent rights of Intersil or its subsidiaries.

For information regarding Intersil Corporation and its products, see web site <http://www.intersil.com>

Sales Office Headquarters

NORTH AMERICA

Intersil Corporation
P. O. Box 883, Mail Stop 53-204
Melbourne, FL 32902
TEL: (407) 724-7000
FAX: (407) 724-7240

EUROPE

Intersil SA
Mercure Center
100, Rue de la Fusee
1130 Brussels, Belgium
TEL: (32) 2.724.2111
FAX: (32) 2.724.22.05

ASIA

Intersil (Taiwan) Ltd.
7F-6, No. 101 Fu Hsing North Road
Taipei, Taiwan
Republic of China
TEL: (886) 2 2716 9310
FAX: (886) 2 2715 3029

70A, 30V, 0.010 Ohm, N-Channel Power MOSFETs

These N-Channel power MOSFETs are manufactured using the MegaFET process. This process, which uses feature sizes approaching those of LSI integrated circuits gives optimum utilization of silicon, resulting in outstanding performance. They were designed for use in applications such as switching regulators, switching converters, motor drivers, and relay drivers. These transistors can be operated directly from integrated circuits.

Formerly developmental type TA49025.

Ordering Information

PART NUMBER	PACKAGE	BRAND
RFP70N03	TO-220AB	RFP70N03
RF1S70N03SM	TO-263AB	F1S70N03

NOTE: When ordering, use the entire part number. Add the suffix 9A to obtain the TO-263AB variant in tape and reel, e.g., RF1S70N03SM9A

Features

- 70A, 30V
- $r_{DS(ON)} = 0.010\Omega$
- Temperature Compensating PSPICE® Model
- Peak Current vs Pulse Width Curve
- UIS Rating Curve (Single Pulse)
- 175°C Operating Temperature
- Related Literature
 - TB334 "Guidelines for Soldering Surface Mount Components to PC Boards"

Symbol

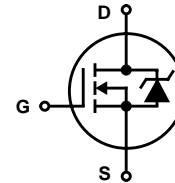

Packaging

JEDEC TO-220AB

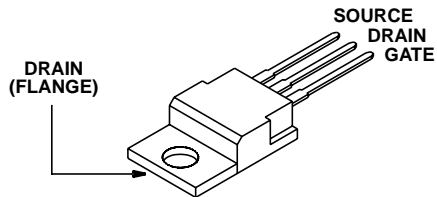

JEDEC TO-263AB

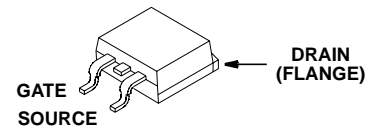

RFP70N03, RF1S70N03SM

Absolute Maximum Ratings $T_C = 25^\circ\text{C}$, Unless Otherwise Specified

			UNITS
Drain to Source Voltage (Note 1)	V_{DSS}	30	V
Drain to Gate Voltage ($R_{GS} = 20k\Omega$) (Note 1)	V_{DGR}	30	V
Gate to Source Voltage	V_{GS}	± 20	V
Drain Current			
Continuous (Figure 2)	I_D	70	A
Pulsed Drain Current	I_{DM}	200	A
Pulsed Avalanche Rating	E_{AS}	Figures 5, 13, 14	
Power Dissipation	P_D	150	W
Derate Above 25°C		1.0	$\text{W}/^\circ\text{C}$
Operating and Storage Temperature	T_J, T_{STG}	-55 to 175	$^\circ\text{C}$
Maximum Temperature for Soldering			
Leads at 0.063in (1.6mm) from case for 10s	T_L	300	$^\circ\text{C}$
Package Body for 10s, see Techbrief 334	T_{pkg}	260	$^\circ\text{C}$

CAUTION: Stresses above those listed in "Absolute Maximum Ratings" may cause permanent damage to the device. This is a stress only rating and operation of the device at these or any other conditions above those indicated in the operational sections of this specification is not implied.

NOTE:

- $T_J = 25^\circ\text{C}$ to 150°C .

Electrical Specifications $T_C = 25^\circ\text{C}$, Unless Otherwise Specified

PARAMETER	SYMBOL	TEST CONDITIONS	MIN	TYP	MAX	UNITS
Drain to Source Breakdown Voltage	BV_{DSS}	$I_D = 250\mu\text{A}, V_{GS} = 0\text{V}$ (Figure 10)	30	-	-	V
Gate to Source Threshold Voltage	$V_{GS(TH)}$	$V_{GS} = V_{DS}, I_D = 250\mu\text{A}$ (Figure 9)	2	-	4	V
Zero Gate Voltage Drain Current	I_{DSS}	$V_{DS} = 30\text{V}, V_{GS} = 0\text{V}$	-	-	1	μA
		$V_{DS} = 30\text{V}, V_{GS} = 0\text{V}, T_C = 150^\circ\text{C}$	-	-	50	μA
Gate to Source Leakage Current	I_{GSS}	$V_{GS} = \pm 20\text{V}$	-	-	100	nA
Drain to Source On Resistance	$r_{DS(ON)}$	$I_D = 70\text{A}, V_{GS} = 10\text{V}$ (Figure 8)	-	-	0.010	Ω
Turn-On Time	t_{ON}	$V_{DD} = 15\text{V}, I_D \cong 70\text{A},$ $R_L = 0.214\Omega, V_{GS} = 10\text{V},$ $R_{GS} = 2.5\Omega$	-	-	80	ns
Turn-On Delay Time	$t_{d(ON)}$		-	20	-	ns
Rise Time	t_r		-	20	-	ns
Turn-Off Delay Time	$t_{d(OFF)}$		-	40	-	ns
Fall Time	t_f		-	25	-	ns
Turn-Off Time	t_{OFF}		-	-	125	ns
Total Gate Charge	$Q_{g(TOT)}$	$V_{GS} = 0\text{V}$ to 20V	-	215	260	nC
Gate Charge at 10V	$Q_{g(10)}$	$V_{GS} = 0\text{V}$ to 10V				
Threshold Gate Charge	$Q_{g(TH)}$	$V_{GS} = 0\text{V}$ to 2V				
Input Capacitance	C_{ISS}	$V_{DS} = 25\text{V}, V_{GS} = 0\text{V},$ $f = 1\text{MHz}$ (Figure 11)	-	3300	-	pF
Output Capacitance	C_{OSS}		-	1750	-	pF
Reverse Transfer Capacitance	C_{RSS}		-	750	-	pF
Thermal Resistance Junction to Case	$R_{\theta JC}$	(Figure 3)	-	-	1.0	$^\circ\text{C}/\text{W}$
Thermal Resistance Junction to Ambient	$R_{\theta JA}$	TO-220, TO-263	-	-	62	$^\circ\text{C}/\text{W}$

Source to Drain Diode Specifications

PARAMETER	SYMBOL	TEST CONDITIONS	MIN	TYP	MAX	UNITS
Source to Drain Diode Voltage	V_{SD}	$I_{SD} = 70\text{A}$	-	-	1.5	V
Reverse Recovery Time	t_{rr}	$I_{SD} = 70\text{A}, dI_{SD}/dt = 100\text{A}/\mu\text{s}$	-	-	125	ns

Typical Performance Curves

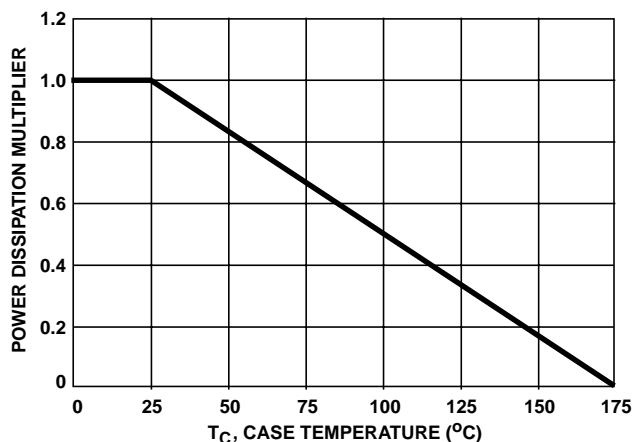

FIGURE 1. NORMALIZED POWER DISSIPATION vs CASE TEMPERATURE

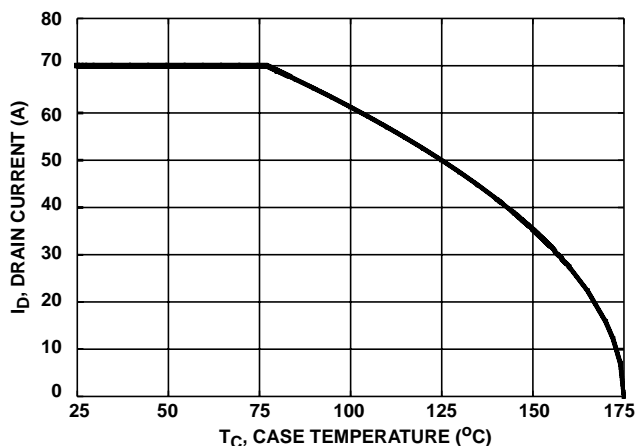

FIGURE 2. MAXIMUM CONTINUOUS DRAIN CURRENT vs CASE TEMPERATURE

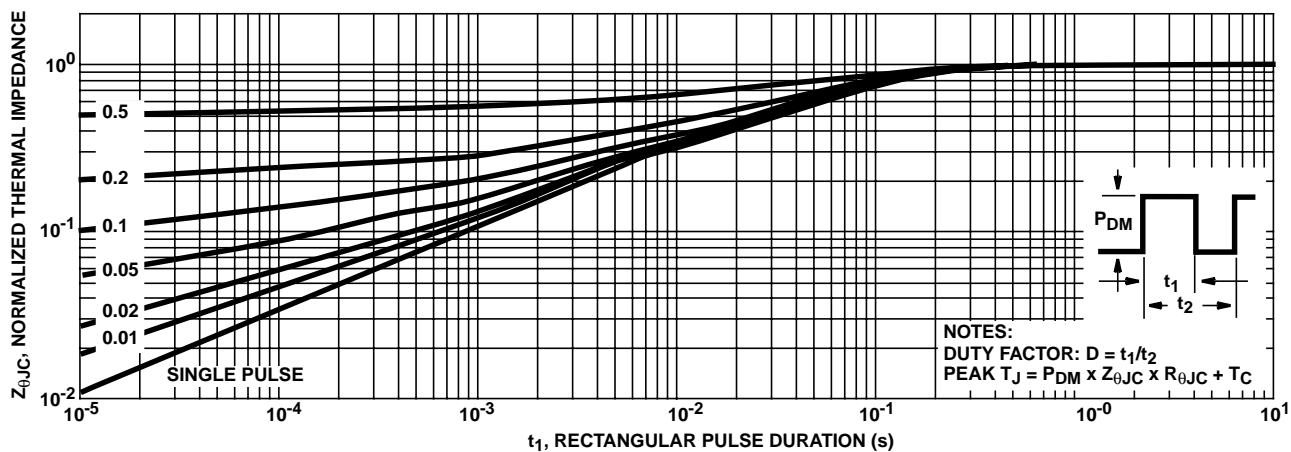

FIGURE 3. NORMALIZED MAXIMUM TRANSIENT THERMAL IMPEDANCE

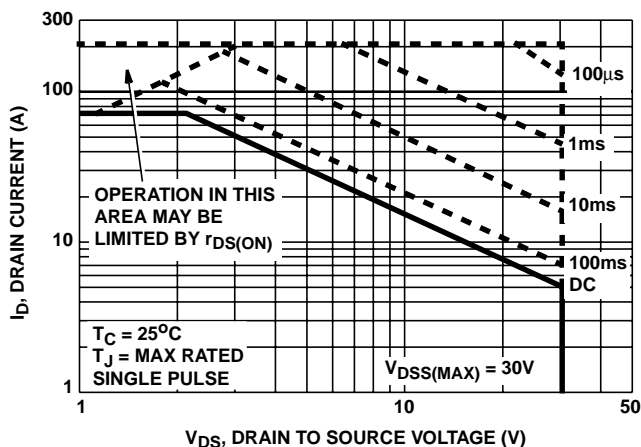
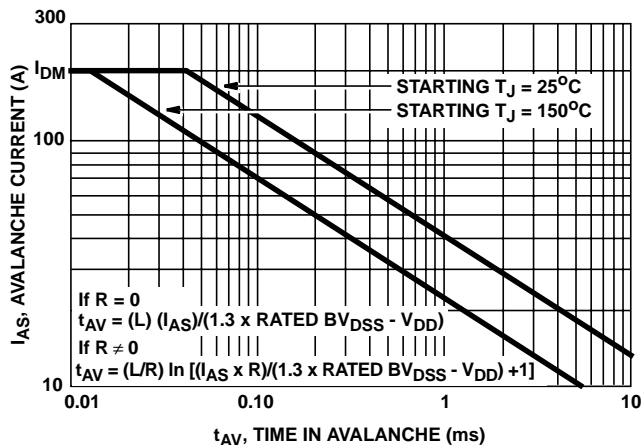

FIGURE 4. FORWARD BIAS SAFE OPERATING AREA



NOTE: Refer to Intersil Application Notes AN9321 and AN9322.

FIGURE 5. UNCLAMPED INDUCTIVE SWITCHING CAPABILITY

Typical Performance Curves (Continued)

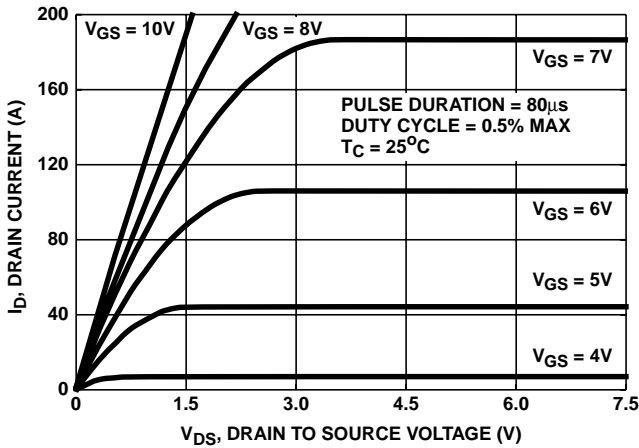

FIGURE 6. SATURATION CHARACTERISTICS

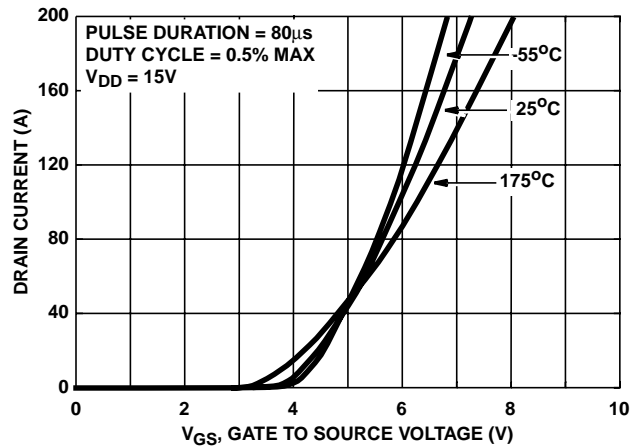

FIGURE 7. TRANSFER CHARACTERISTICS

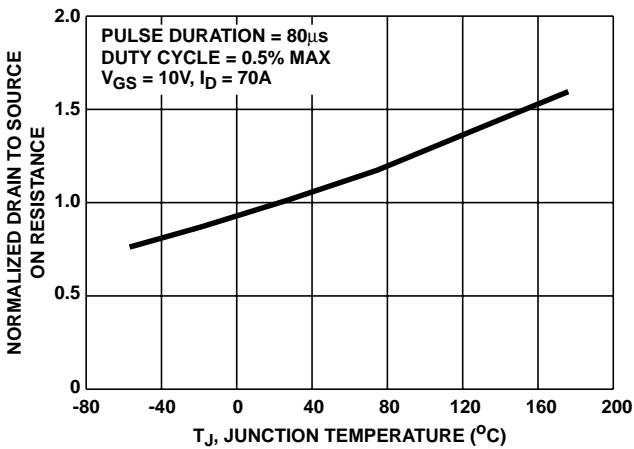

FIGURE 8. NORMALIZED DRAIN TO SOURCE ON RESISTANCE vs JUNCTION TEMPERATURE

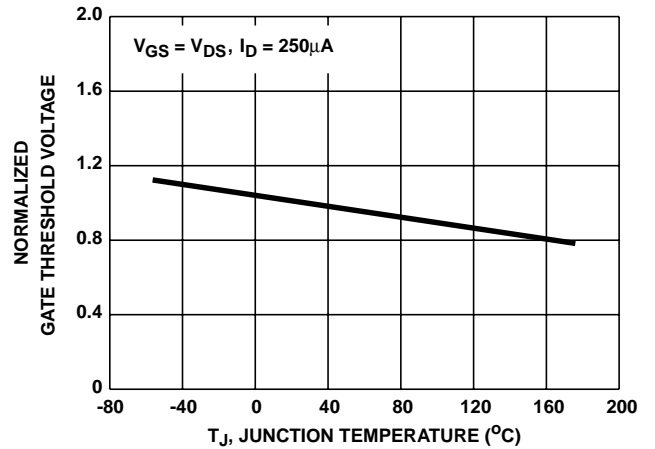

FIGURE 9. NORMALIZED GATE THRESHOLD VOLTAGE vs JUNCTION TEMPERATURE

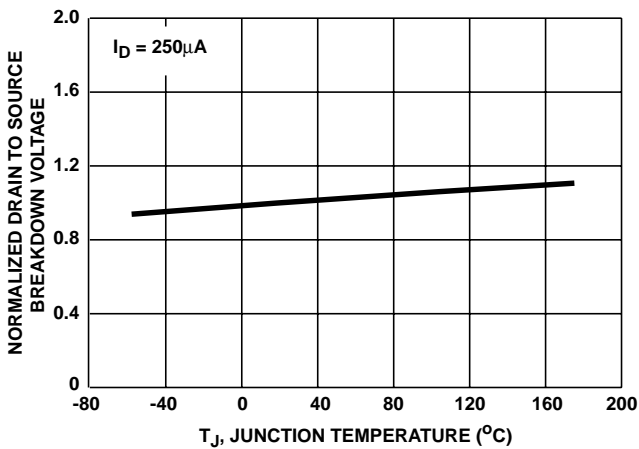

FIGURE 10. NORMALIZED DRAIN TO SOURCE BREAKDOWN VOLTAGE vs JUNCTION TEMPERATURE

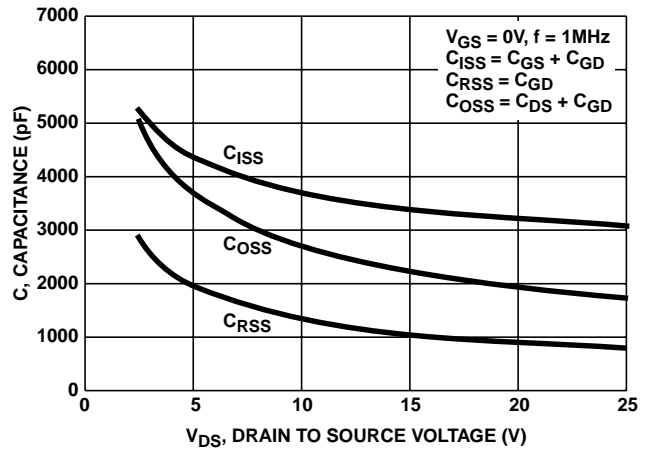
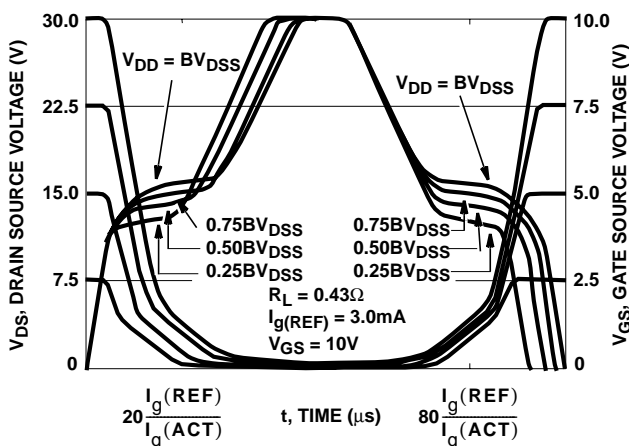

FIGURE 11. CAPACITANCE vs DRAIN TO SOURCE VOLTAGE

Typical Performance Curves (Continued)



NOTE: Refer to Intersil Application Notes AN7254 and AN7260.

FIGURE 12. GATE CHARGE WAVEFORMS FOR CONSTANT GATE CURRENT

Test Circuits and Waveforms

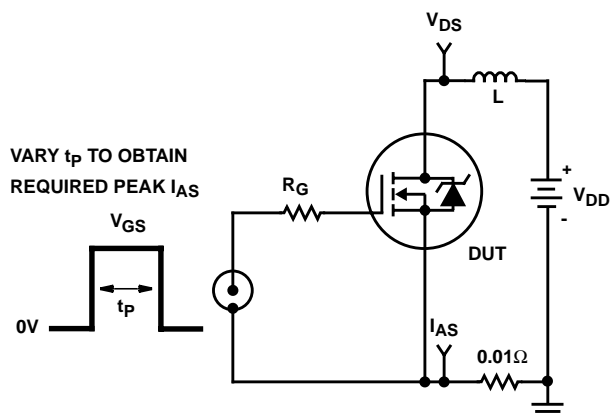

FIGURE 13. UNCLAMPED ENERGY TEST CIRCUIT

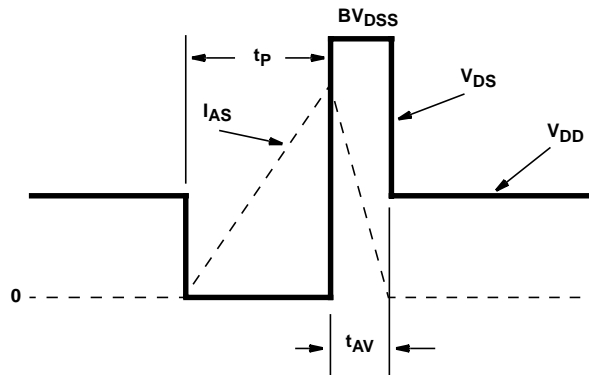

FIGURE 14. UNCLAMPED ENERGY WAVEFORMS

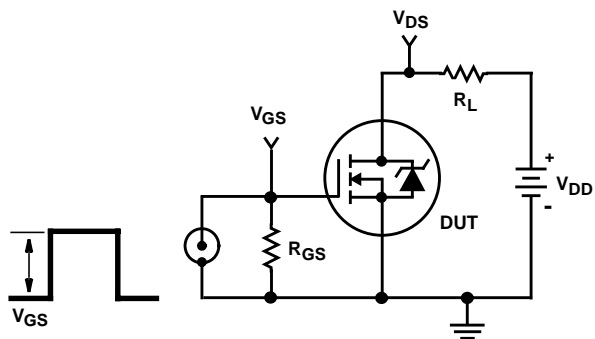

FIGURE 15. SWITCHING TIME TEST CIRCUIT

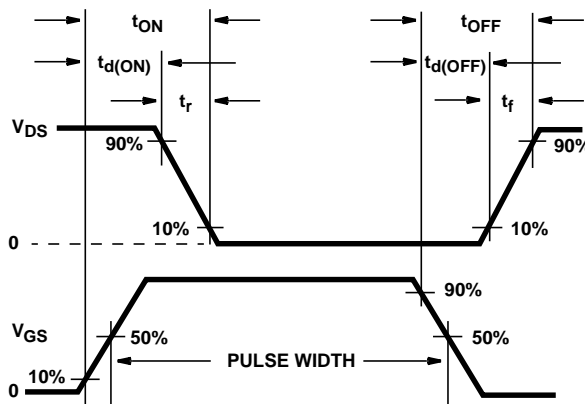

FIGURE 16. SWITCHING WAVEFORMS

Test Circuits and Waveforms (Continued)

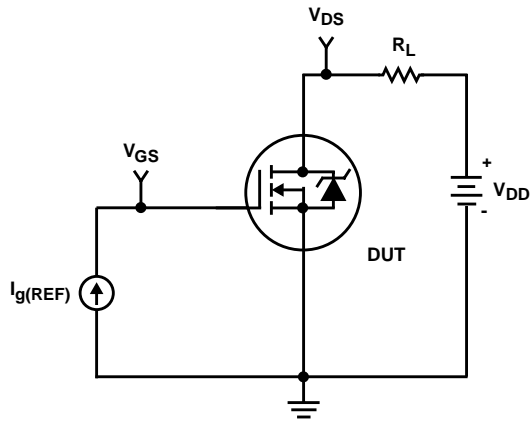

FIGURE 17. GATE CHARGE TEST CIRCUIT

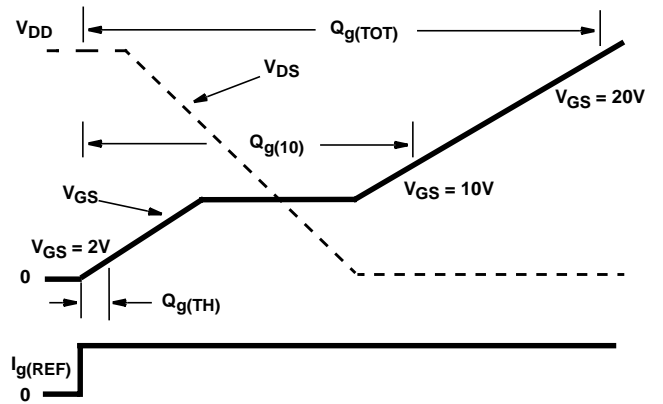

FIGURE 18. GATE CHARGE WAVEFORM

PSPICE Electrical Model

.SUBCKT RFP70N03 2 1 3 ; rev 9/16/92
 *NOM TEMP = 25°C

CA 12 8 6.09e-9
 CB 15 14 6.05e-9
 CIN 6 8 3.40e-9

DBODY 7 5 DBDMOD
 DBREAK 5 11 DBKMOD
 DPLCAP 10 5 DPLCAPMOD

EBREAK 11 7 17 18 35.4
 EDS 14 8 5 8 1
 EGS 13 8 6 8 1
 ESG 6 10 6 8 1
 EVTO 20 6 18 8 1

IT 8 17 1

LDRAIN 2 5 1e-9
 LGATE 1 9 3.10e-9
 LSOURCE 3 7 1.82e-9

MOS1 16 6 8 8 MOSMOD M=0.99
 MOS2 16 21 8 8 MOSMOD M=0.01

RBREAK 17 18 RBKMOD 1
 RDRAIN 5 16 RDSMOD 30.7e-6
 RGATE 9 20 0.890
 RIN 6 8 1e9
 RSOURCE 8 7 RDSMOD 3.92e-3
 RVTO 18 19 RVTOMOD 1

S1A 6 12 13 8 S1AMOD
 S1B 13 12 13 8 S1BMOD
 S2A 6 15 14 13 S2AMOD
 S2B 13 15 14 13 S2BMOD

VBAT 8 19 DC 1
 VTO 21 6 0.605

.MODEL DBDMOD D (IS=7.91e-12 RS=3.87e-3 TRS1=2.71e-3 TRS2=2.50e-7 CJO=4.84e-9 TT=4.51e-8)
 .MODEL DBKMOD D (RS=3.9e-2 TRS1=1.05e-4 TRS2=3.11e-5)
 .MODEL DPLCAPMOD D (CJO=4.8e-9 IS=1e-30 N=10)
 .MODEL MOSMOD NMOS (VTO=3.46 KP=47 IS=1e-30 N=10 TOX=1 L=1u W=1u)
 .MODEL RBKMOD RES (TC1=8.46e-4 TC2=-8.48e-7)
 .MODEL RDSMOD RES (TC1=2.23e-3 TC2=6.56e-6)
 .MODEL RVTOMOD RES (TC1=-3.29e-3 TC2=3.49e-7)
 .MODEL S1AMOD VSWITCH (RON=1e-5 ROFF=0.1 VON=-8.35 VOFF=-6.35)
 .MODEL S1BMOD VSWITCH (RON=1e-5 ROFF=0.1 VON=-6.35 VOFF=-8.35)
 .MODEL S2AMOD VSWITCH (RON=1e-5 ROFF=0.1 VON=-2.0 VOFF=3.0)
 .MODEL S2BMOD VSWITCH (RON=1e-5 ROFF=0.1 VON=3.0 VOFF=-2.0)

.ENDS

NOTE: For further discussion of the PSPICE model consult **A New PSPICE Sub-circuit for the Power MOSFET Featuring Global Temperature Options**; written by William J. Hepp and C. Frank Wheatley.

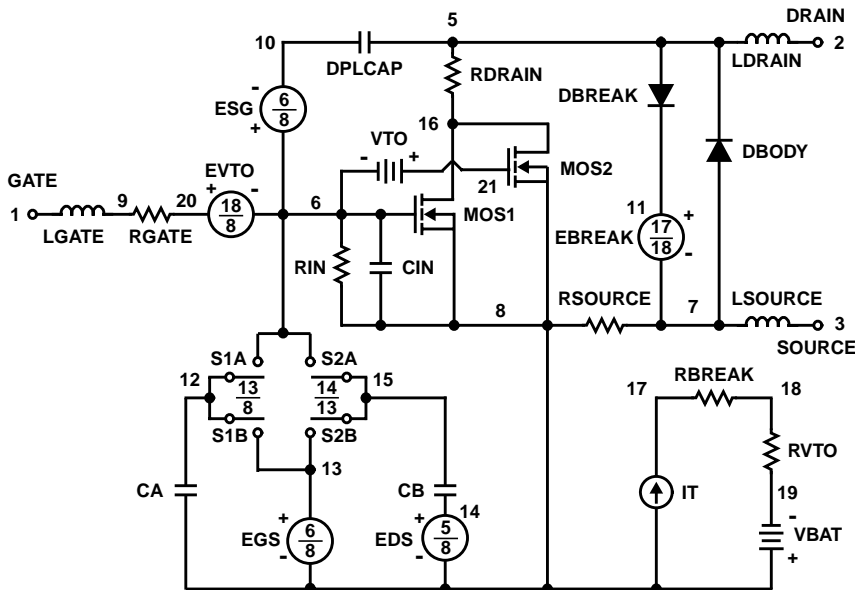

All Intersil semiconductor products are manufactured, assembled and tested under **ISO9000** quality systems certification.

Intersil semiconductor products are sold by description only. Intersil Corporation reserves the right to make changes in circuit design and/or specifications at any time without notice. Accordingly, the reader is cautioned to verify that data sheets are current before placing orders. Information furnished by Intersil is believed to be accurate and reliable. However, no responsibility is assumed by Intersil or its subsidiaries for its use; nor for any infringements of patents or other rights of third parties which may result from its use. No license is granted by implication or otherwise under any patent or patent rights of Intersil or its subsidiaries.

For information regarding Intersil Corporation and its products, see web site <http://www.intersil.com>

Sales Office Headquarters

NORTH AMERICA

Intersil Corporation
P. O. Box 883, Mail Stop 53-204
Melbourne, FL 32902
TEL: (407) 724-7000
FAX: (407) 724-7240

EUROPE

Intersil SA
Mercure Center
100, Rue de la Fusee
1130 Brussels, Belgium
TEL: (32) 2.724.2111
FAX: (32) 2.724.22.05

ASIA

Intersil (Taiwan) Ltd.
7F-6, No. 101 Fu Hsing North Road
Taipei, Taiwan
Republic of China
TEL: (886) 2 2716 9310
FAX: (886) 2 2715 3029