

GaAs IC 4 Bit Digital Attenuator

1 dB LSB Positive Control 0.5–2.5 GHz



AA226-87

Features

- Attenuation 1 dB Steps to 15 dB with High Accuracy
- Single Positive Control (+3 to +5 V) for Each Bit
- Low DC Power Consumption
- Small Low Cost TSSOP-16 Plastic Package

Description

The AA226-87 is a 4 bit, single positive control GaAs IC FET digital attenuator. It requires DC blocking capacitors, positive supply voltage (V_S) and four individual positive bit control voltages (V_1 – V_4). The AA226-87 is particularly suited where high attenuation accuracy, low insertion loss and low intermodulation products are required. Typical applications include base station, wireless data and wireless local loop gain control circuits.

TSSOP-16

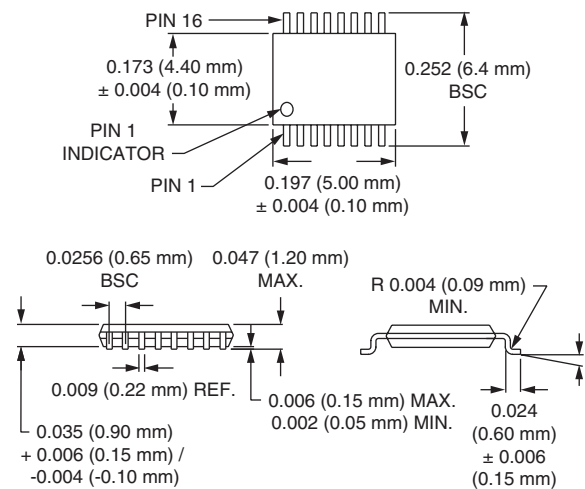

Electrical Specifications at -40°C to +85°C (0, +5 V)

Parameter ¹	Condition	Frequency	Min.	Typ.	Max.	Unit
Insertion Loss		0.5–1.0 GHz		1.3	1.7	dB
		1.0–2.0 GHz		1.7	2.2	dB
		2.0–2.5 GHz		2.3	2.6	dB
Attenuation Range				15		dB
Attenuation Accuracy ²		0.5–1.0 GHz	± (0.2 + 3% of Attenuation Setting in dB)			dB
		1.0–2.5 GHz	± (0.3 + 4% of Attenuation Setting in dB)			dB
VSWR (I/O) ³		0.5–2.5 GHz		1.5:1	2.0:1	
Switching Characteristics ⁴	Rise, Fall (10/90% or 90/10% RF) On, Off (50% CTL to 90/10% RF) Video Feedthru			150		ns
				300		ns
				70		mV
Input Power for 1 dB Compression	$V_S = +3\text{ V}$ $V_S = +5\text{ V}$	0.5–2.5 GHz	+20	+25		dBm
		0.5–2.5 GHz	+24	+30		dBm
Intermodulation Intercept Point (IP3)	For Two-tone Input Power +5 dBm $V_S = +3\text{ V}$ $V_S = +5\text{ V}$	0.5–2.5 GHz	+43	+49		dBm
		0.5–2.5 GHz	+44	+50		dBm
Control Voltages	$V_{Low} = 0\text{ to }0.2\text{ V @ }20\text{ }\mu\text{A Max.}$ $V_{High} = +3\text{ V @ }100\text{ }\mu\text{A Max. to }+5\text{ V @ }200\text{ }\mu\text{A Max.}$ $V_S = V_{High} \pm 0.2\text{ V}$					

1. All measurements made in a 50 Ω system, unless otherwise specified.
2. Attenuation referenced to insertion loss.

3. Input/output.
4. Video feedthru measured with 1 ns risetime pulse and 500 MHz bandwidth.

Typical Performance Data (0, +5 V)

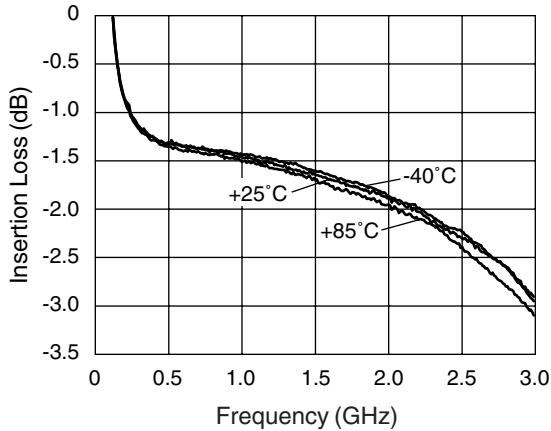

Insertion Loss vs. Frequency

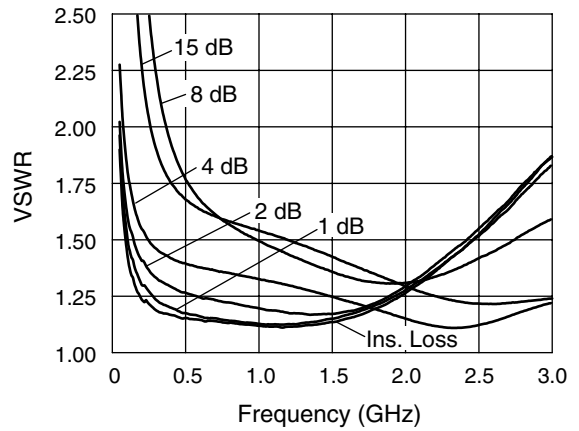

VSWR vs. Frequency (25°C)

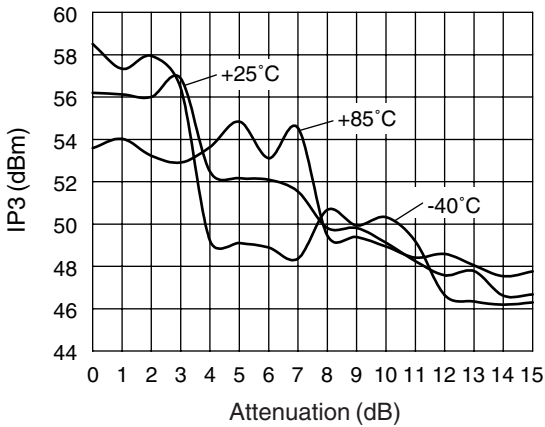

IP3 vs. Attenuation and Temperature (500 MHz)

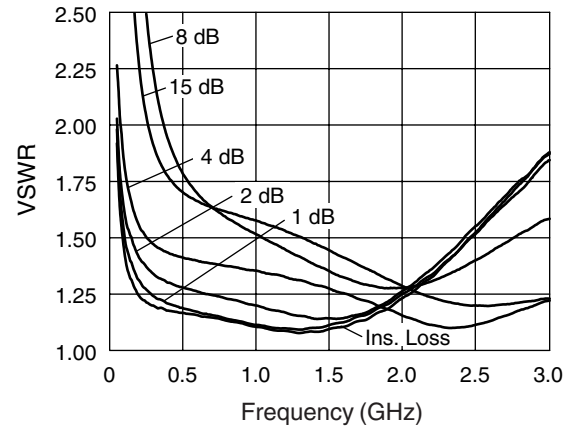

VSWR vs. Frequency (85°C)

Compression Point vs. Attenuation, Voltage, and Temperature

Attenuation State	Control Voltage (V)	Input Power @ 1 dB Compression		
		+25°C (dBm)	+85°C (dBm)	-40°C (dBm)
Ins. Loss	5	31.6	31.0	30.8
1 dB	5	31.9	31.5	31.2
2 dB	5	31.4	31.1	30.9
4 dB	5	32.7	31.5	34.8
8 dB	5	33.0	32.8	33.5
15 dB	5	30.7	28.5	31.7

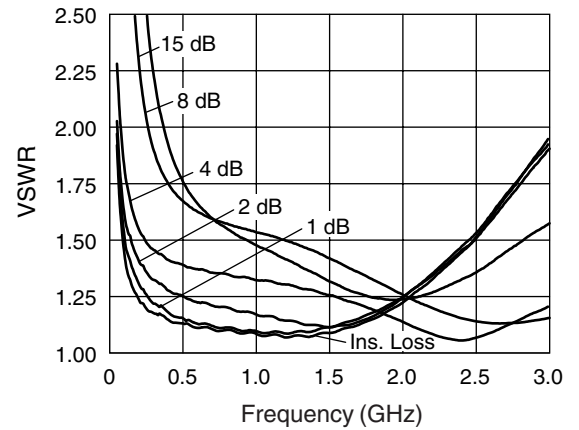

VSWR vs. Frequency (-40°C)

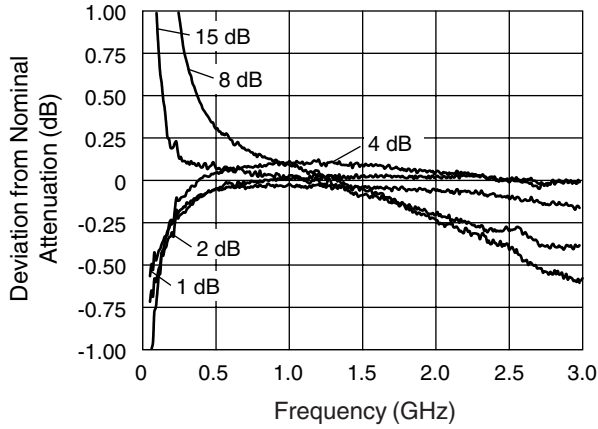

Attenuation Accuracy vs. Frequency (25°C)

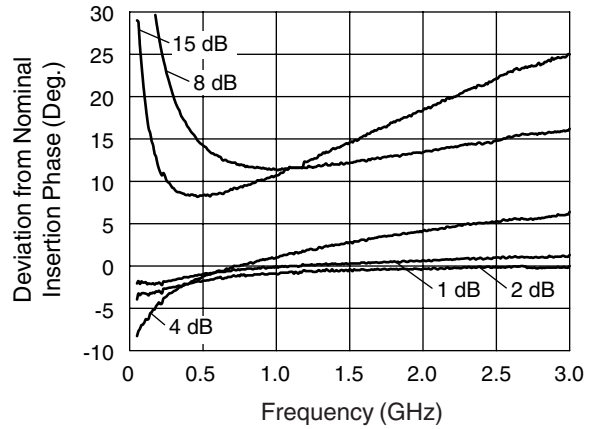

Attenuation Phase Accuracy vs. Frequency (25°C)

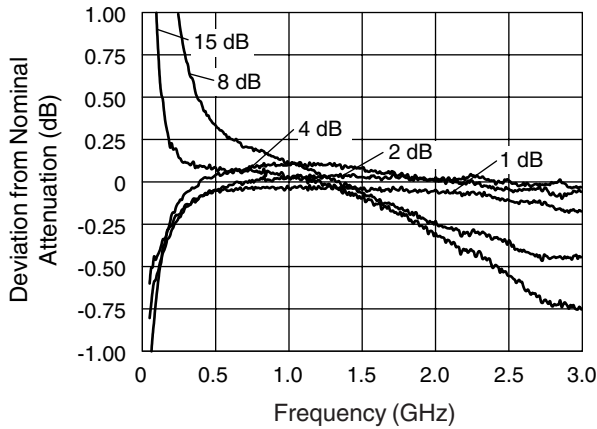

Attenuation Accuracy vs. Frequency (85°C)

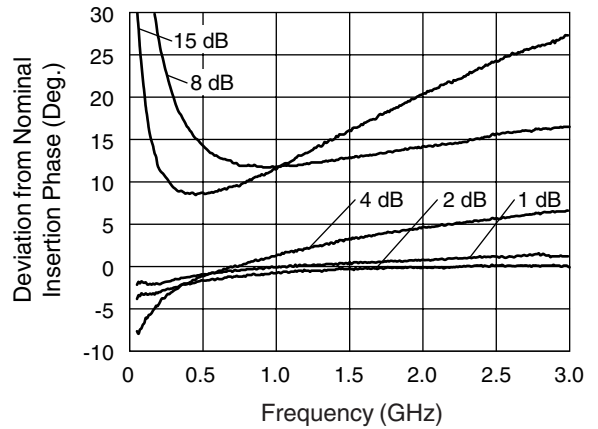

Attenuation Phase Accuracy vs. Frequency (85°C)

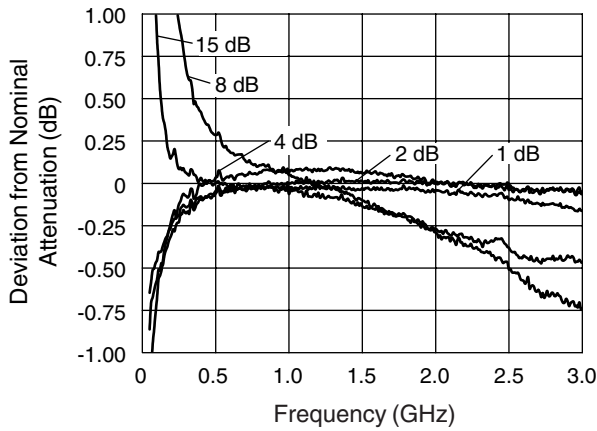

Attenuation Accuracy vs. Frequency (-40°C)

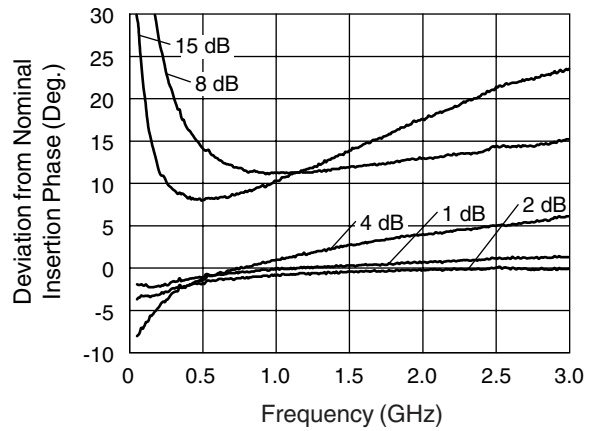

Attenuation Phase Accuracy vs. Frequency (-40°C)

Typical Performance Data (0, +3 V)

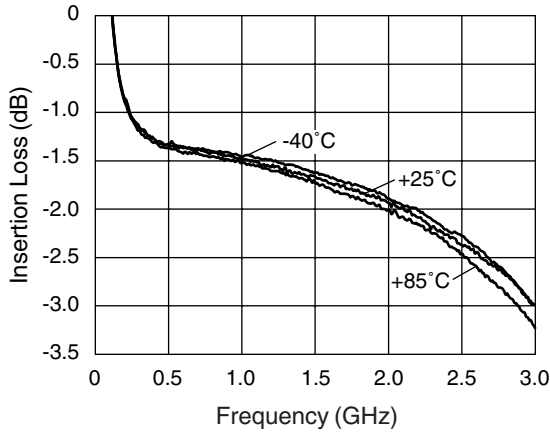

Insertion Loss vs. Frequency

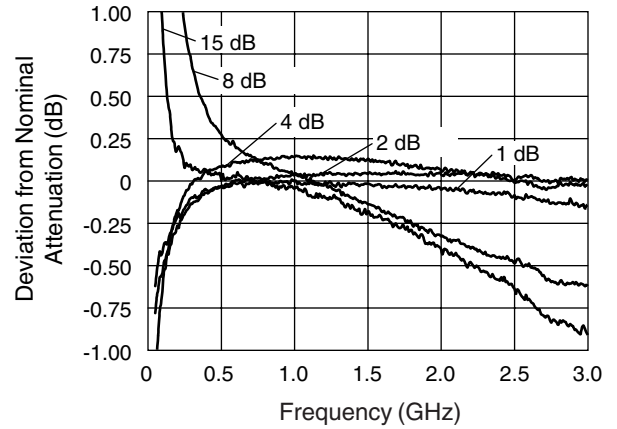

Attenuation Accuracy vs. Frequency (25°C)

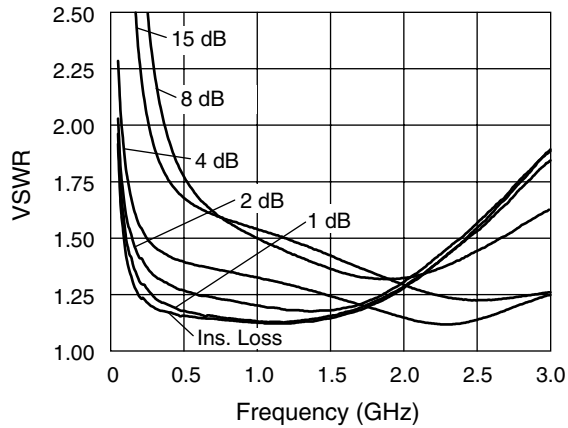

VSWR vs. Frequency (25°C)

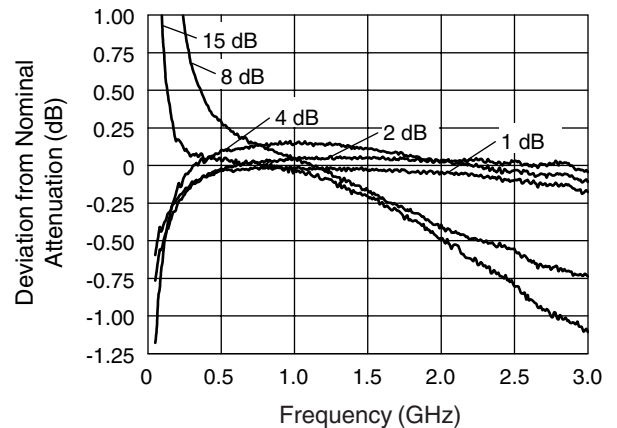

Attenuation Accuracy vs. Frequency (85°C)

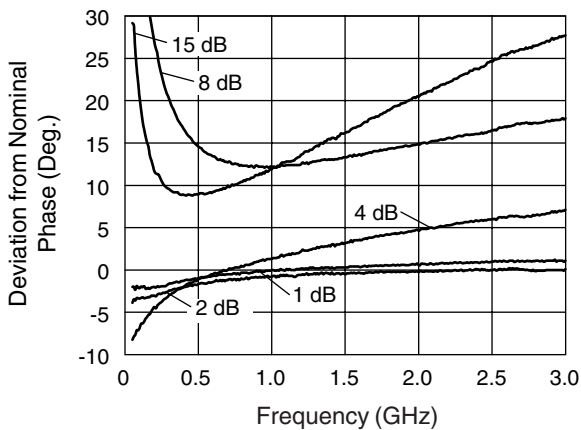

Attenuation Phase Accuracy vs. Frequency (25°C)

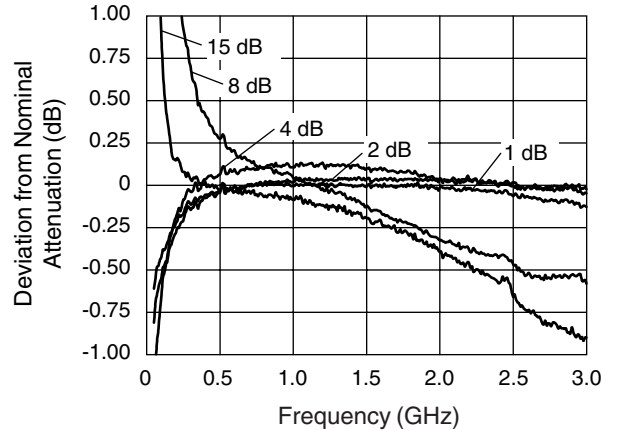

Attenuation Accuracy vs. Frequency (-40°C)

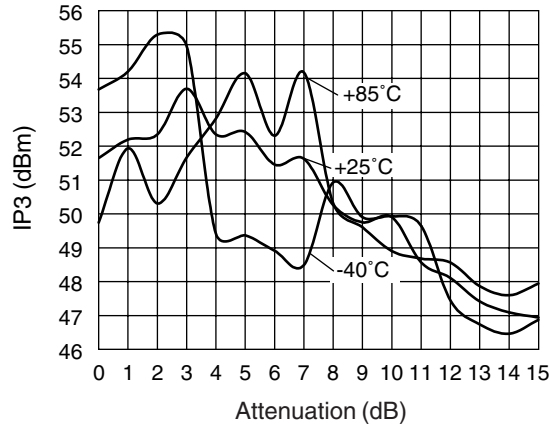

IP3 vs. Attenuation and Temperature (500 MHz)

Compression Point vs. Attenuation, Voltage, and Temperature

Attenuation State	Control Voltage (V)	Input Power @ 1 dB Compression		
		+25°C (dBm)	+85°C (dBm)	-40°C (dBm)
Ins. Loss	3	24.5	24.1	24.6
1 dB	3	25.2	24.8	25.2
2 dB	3	25.0	24.3	24.9
4 dB	3	31.2	30.4	32.8
8 dB	3	28.3	26.3	29.2
15 dB	3	26.6	24.8	27.5

Truth Table

V ₁	V ₂	V ₃	V ₄	Attenuation J ₁ -J ₂
8 dB	4 dB	2 dB	1 dB	Reference I.L.
V _{High}	V _{High}	V _{High}	V _{High}	Reference I.L.
V _{High}	V _{High}	V _{High}	0	1 dB
V _{High}	V _{High}	0	V _{High}	2 dB
V _{High}	0	V _{High}	V _{High}	4 dB
0	V _{High}	V _{High}	V _{High}	8 dB
0	0	0	0	15 dB Max. Atten.

V_{High} = +3 to +5 V (V_S = V_{High} ± 0.2 V).

Pin Out

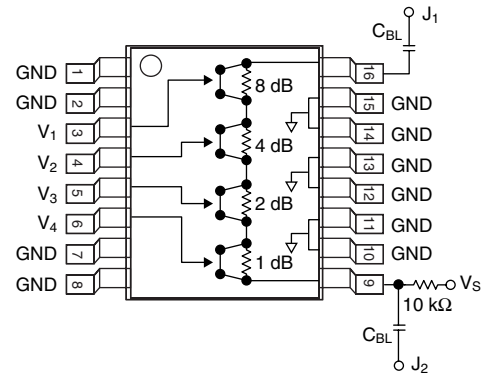

DC blocking capacitors (C_{BL}) and biasing resistor must be supplied externally for positive voltage operation.
C_{BL} = 47 pF for operation >500 MHz.

Absolute Maximum Ratings

Characteristic	Value
RF Input Power	1 W > 500 MHz 0/8 V 0.5 W @ 50 MHz 0/8 V
Supply Voltage	+8 V
Control Voltage	-0.2 V, +8 V
Operating Temperature	-40°C to +85°C
Storage Temperature	-65°C to +150°C

Note: Exceeding these parameters may cause irreversible damage.