

GaAs IC 4 Bit Digital Attenuator

1 dB LSB Positive Control 0.5–3.0 GHz



AA105-86

Features

- Attenuation 1 dB Steps to 15 dB with High Accuracy
- Single Positive Control (+3 to +5 V) for Each Bit
- Low DC Power Consumption
- Miniature Low Cost MSOP-10 Plastic Package

Description

The AA105-86 is a 4 bit, single positive control GaAs IC FET digital attenuator. It requires DC blocking capacitors, positive supply voltage (V_S) and four individual positive bit control voltages (V_1 – V_4). The AA105-86 is particularly suited where high attenuation accuracy, low insertion loss and low intermodulation products are required. Typical applications include cellular radio, wireless data, and wireless local loop gain level control circuits.

MSOP-10

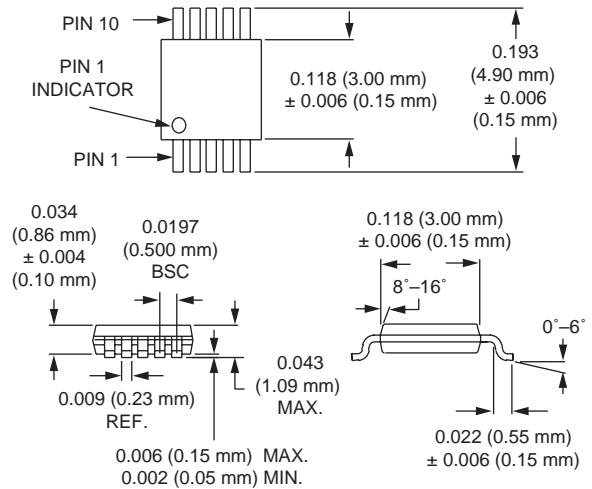

Electrical Specifications at -40°C to +85°C (0, +5 V)

Parameter ¹	Condition	Frequency	Min.	Typ.	Max.	Unit
Insertion Loss		0.5–1.0 GHz		1.5	1.8	dB
		1.0–2.0 GHz		2.1	2.4	dB
		2.0–2.5 GHz		2.4	2.7	dB
		2.5–3.0 GHz		2.7	3.0	dB
Attenuation Range				15		dB
Attenuation Accuracy ²		0.5–1.0 GHz	± (0.2 + 2% of Attenuation Setting in dB)			dB
		1.0–3.0 GHz	± (0.3 + 3% of Attenuation Setting in dB)			dB
VSWR (I/O) ³		0.5–2.5 GHz 2.5–3.0 GHz		1.5:1 1.7:1	2.0:1 2.2:1	
Switching Characteristics ⁴	Rise, Fall (10/90% or 90/10% RF) On, Off (50% CTL to 90/10% RF) Video Feedthru			180		ns
				270		ns
				50		mV
Input Power for 1 dB Compression	$V_S = +3$ V	0.5–3.0 GHz	+20	+24		dBm
	$V_S = +5$ V	0.5–3.0 GHz	+25	+29		dBm
Intermodulation Intercept Point (IP3)	For Two-tone Input Power +5 dBm $V_S = +3$ V $V_S = +5$ V	0.5–3.0 GHz	+43	+49		dBm
		0.5–3.0 GHz	+44	+50		dBm
Control Voltages	$V_{Low} = 0$ to 0.2 V @ 20 μ A Max. $V_{High} = +3$ V @ 100 μ A Max. to $+5$ V @ 200 μ A Max. $V_S = V_{High} \pm 0.2$ V					

1. All measurements made in a 50 Ω system, unless otherwise specified.
2. Attenuation referenced to insertion loss.

3. Input/output.
4. Video feedthru measured with 1 ns risetime pulse and 500 MHz bandwidth.

Typical Performance Data (0, +5 V)

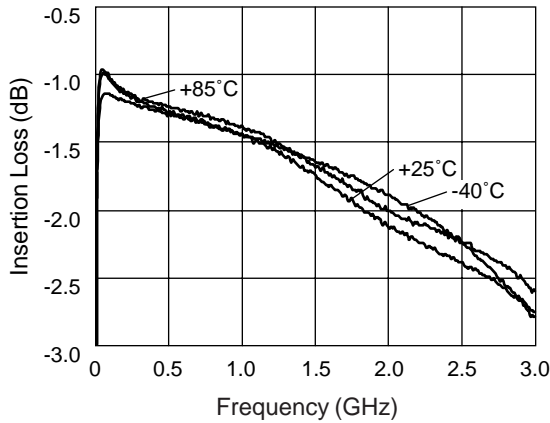

Insertion Loss vs. Frequency

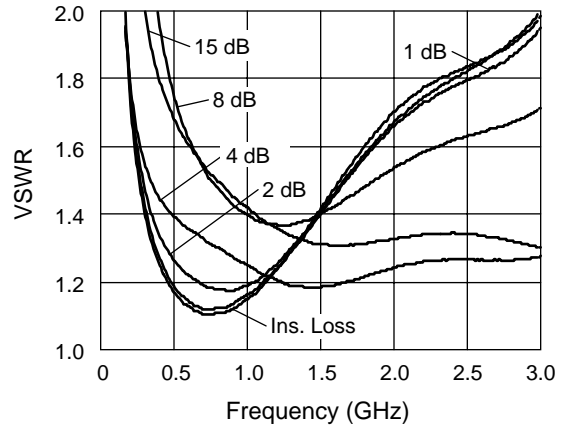

VSWR vs. Frequency (25°C)

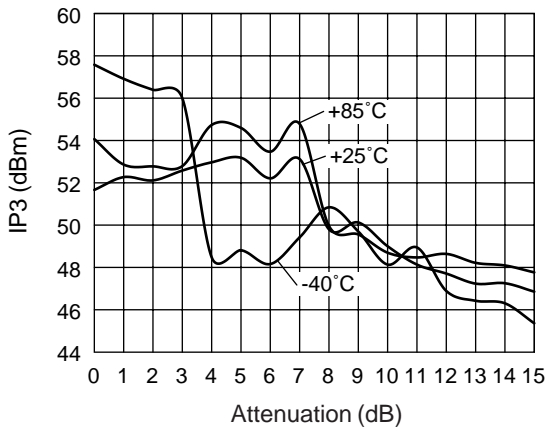

IP3 vs. Attenuation and Temperature (500 MHz)

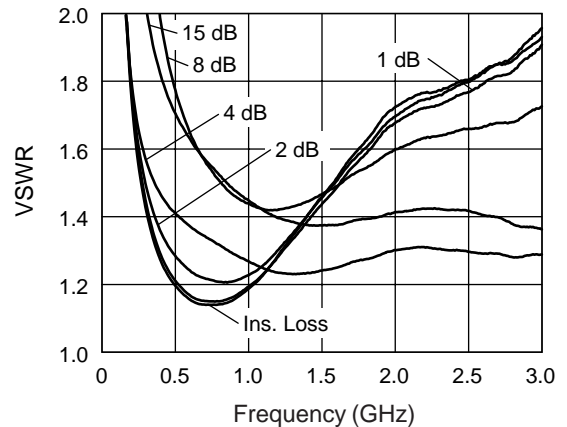

VSWR vs. Frequency (85°C)

Compression Point vs. Attenuation, Voltage, and Temperature

Attenuation State	Control Voltage (V)	Input Power @ 1 dB Compression		
		+25°C (dBm)	+85°C (dBm)	-40°C (dBm)
Ins. Loss	5	31.1	30.9	31.2
1 dB	5	31.3	31.4	31.3
2 dB	5	31.0	30.8	31.1
4 dB	5	32.5	31.4	33.6
8 dB	5	33.0	32.4	33.5
15 dB	5	29.9	28.0	31.4

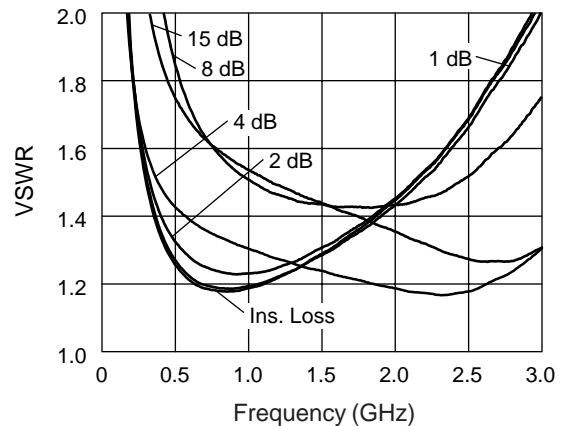

VSWR vs. Frequency (-40°C)

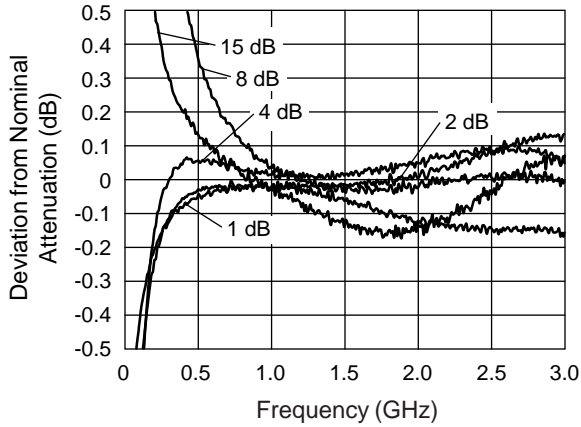

Attenuation Accuracy vs. Frequency (25°C)

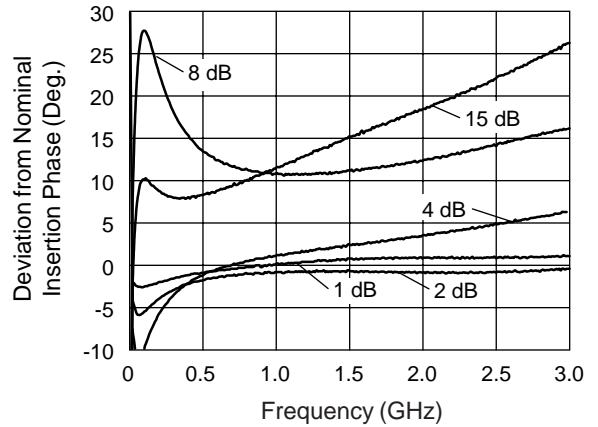

Attenuation Phase Accuracy vs. Frequency (25°C)

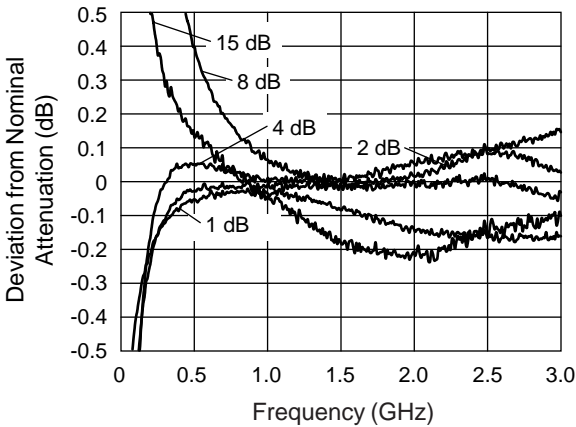

Attenuation Accuracy vs. Frequency (85°C)

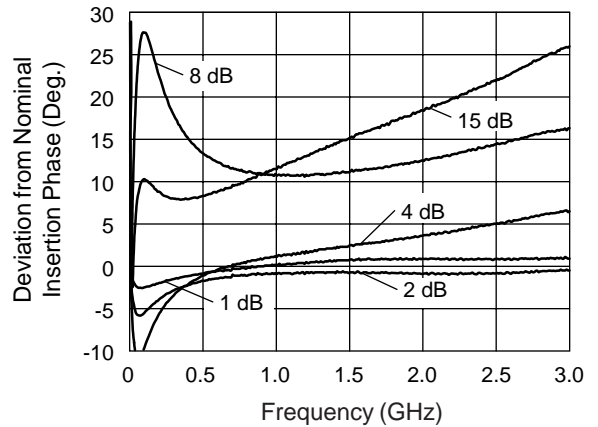

Attenuation Phase Accuracy vs. Frequency (85°C)

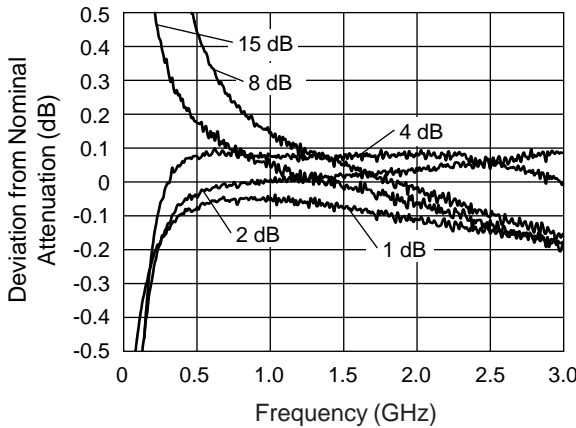

Attenuation Accuracy vs. Frequency (-40°C)

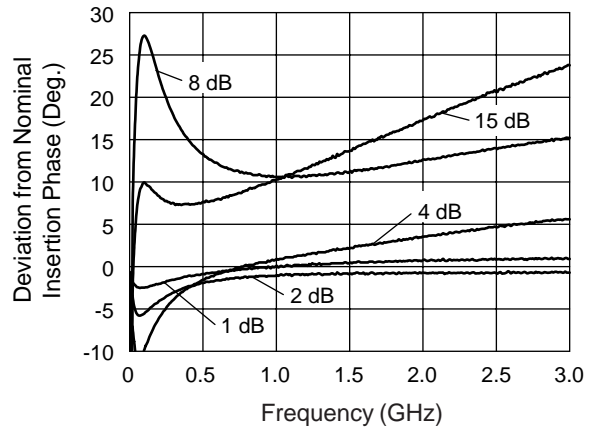

Attenuation Phase Accuracy vs. Frequency (-40°C)

Typical Performance Data (0, +3 V)

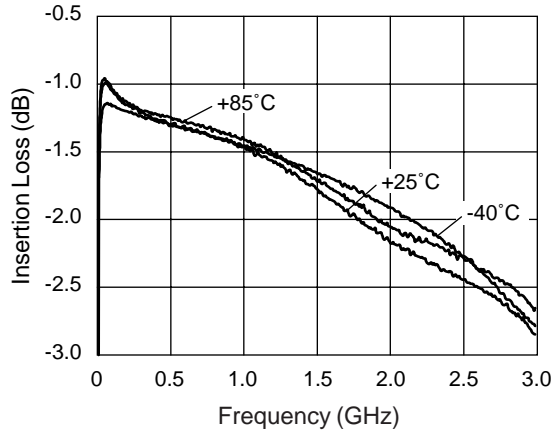

Insertion Loss vs. Frequency

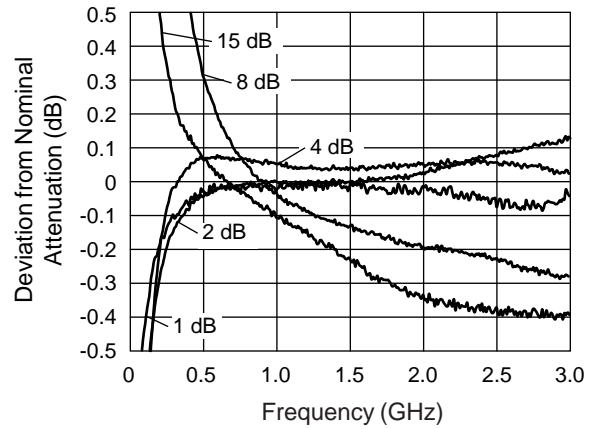

Attenuation Accuracy vs. Frequency (25°C)

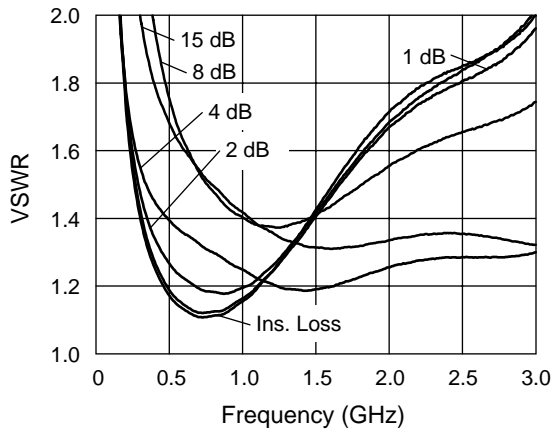

VSWR vs. Frequency (25°C)

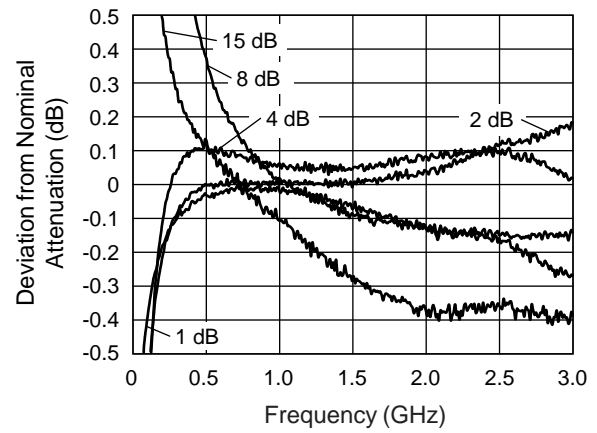

Attenuation Accuracy vs. Frequency (85°C)

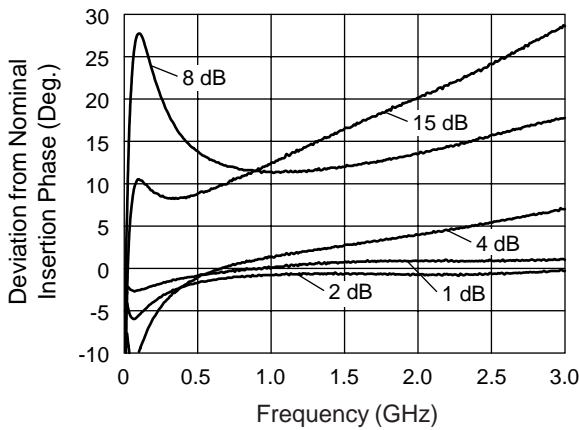

Attenuation Phase Accuracy vs. Frequency (25°C)

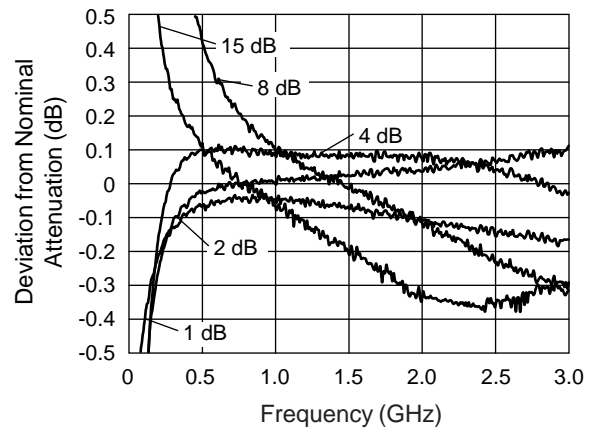

Attenuation Accuracy vs. Frequency (-40°C)

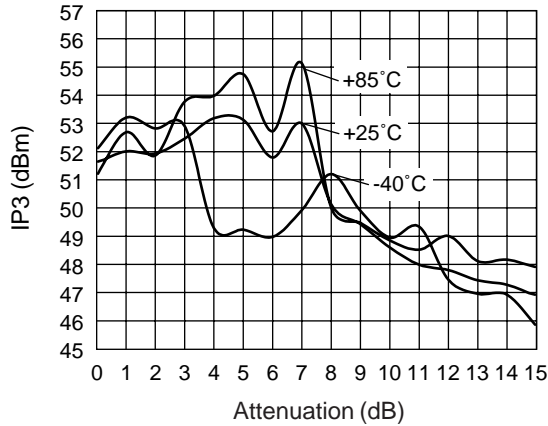

IP3 vs. Attenuation and Temperature (500 MHz)

Compression Point vs. Attenuation, Voltage, and Temperature

Attenuation State	Control Voltage (V)	Input Power @ 1 dB Compression		
		+25°C (dBm)	+85°C (dBm)	-40°C (dBm)
Ins. Loss	3	24.7	24.2	24.4
1 dB	3	25.2	24.9	25.0
2 dB	3	24.8	24.2	24.7
4 dB	3	31.1	30.5	31.9
8 dB	3	25.1	25.9	27.3
15 dB	3	24.9	24.4	27.0

Truth Table

V ₁	V ₂	V ₃	V ₄	Attenuation J ₁ -J ₂
8 dB	4 dB	2 dB	1 dB	Reference I.L.
V _{High}	V _{High}	V _{High}	V _{High}	Reference I.L.
V _{High}	V _{High}	V _{High}	0	1 dB
V _{High}	V _{High}	0	V _{High}	2 dB
V _{High}	0	V _{High}	V _{High}	4 dB
0	V _{High}	V _{High}	V _{High}	8 dB
0	0	0	0	15 dB Max. Atten.

V_{High} = +3 to +5 V (V_S = V_{High} ± 0.2 V).

Pin Out

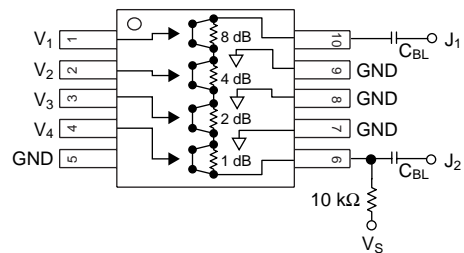

DC blocking capacitors (C_{BL}) and biasing resistor must be supplied externally for positive voltage operation.
C_{BL} = 47 pF for operation >500 MHz.

Absolute Maximum Ratings

Characteristic	Value
RF Input Power	1 W > 500 MHz 0/8 V 0.5 W @ 50 MHz 0/8 V
Supply Voltage	+8 V
Control Voltage	-0.2 V, +8 V
Operating Temperature	-40°C to +85°C
Storage Temperature	-65°C to +150°C

Note: Exceeding these parameters may cause irreversible damage.