

# GaAs IC 5 Bit Digital Attenuator

## 0.5 dB LSB Positive Control 0.5–2.5 GHz



AA102-80

### Features

- Attenuation 0.5 dB Steps to 15.5 dB with High Accuracy
- Single Positive Control (+3 to +5 V) for Each Bit
- Low DC Power Consumption
- Small Low Cost SSOP-16 Plastic Package

### Description

The AA102-80 is a 5 bit, single positive control GaAs IC FET digital attenuator in a low cost SSOP-16 package. This attenuator has an LSB of 0.5 dB and a total attenuation of 15.5 dB. The attenuator requires external DC blocking capacitors, positive supply voltage ( $V_S$ ) and five individual bit control voltages ( $V_1$ – $V_5$ ). It is particularly suited where high attenuation accuracy, low insertion loss and low intermodulation products are required. Typical applications include base station, wireless data, and wireless local loop gain level control circuits.

### SSOP-16

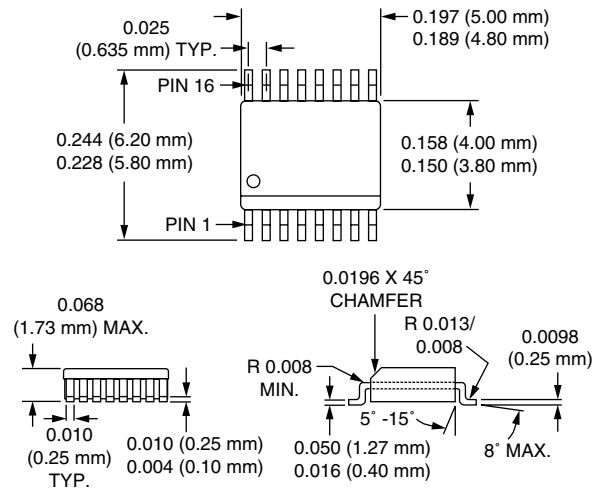

### Electrical Specifications at -40°C to +85°C (0, +5 V)

Parameter <sup>1</sup>	Condition	Frequency	Min.	Typ.	Max.	Unit
Insertion Loss		0.5–1.0 GHz		1.9	2.3	dB
		1.0–2.0 GHz		2.4	2.7	dB
		2.0–2.5 GHz		2.8	3.1	dB
Attenuation Range				15.5		dB
Attenuation Accuracy <sup>2</sup>		0.5–1.0 GHz	± (0.2 + 3% of Attenuation Setting in dB)			dB
		1.0–2.5 GHz	± (0.3 + 5% of Attenuation Setting in dB)			dB
VSWR (I/O) <sup>3</sup>		0.5–2.5 GHz		1.5:1	2.0:1	
Switching Characteristics <sup>4</sup>	Rise, Fall (10/90% or 90/10% RF) On, Off (50% CTL to 90/10% RF) Video Feedthru			125		ns
				250		ns
				75		mV
Input Power for 1 dB Compression	$V_S = +3\text{ V}$ $V_S = +5\text{ V}$	0.5–2.5 GHz	+20	+24		dBm
		0.5–2.5 GHz	+24	+30		dBm
Intermodulation Intercept Point (IP3)	For Two-tone Input Power +5 dBm $V_S = +3\text{ V}$ $V_S = +5\text{ V}$	0.5–2.5 GHz	+42	+48		dBm
		0.5–2.5 GHz	+43	+49		dBm
Control Voltages	$V_{Low} = 0\text{ to }0.2\text{ V @ }20\text{ }\mu\text{A Max.}$ $V_{High} = +3\text{ V @ }100\text{ }\mu\text{A Max. to }+5\text{ V @ }200\text{ }\mu\text{A Max.}$ $V_S = V_{High} \pm 0.2\text{ V}$					

1. All measurements made in a 50  $\Omega$  system, unless otherwise specified.  
2. Attenuation referenced to insertion loss.

3. Input/output.  
4. Video feedthru measured with 1 ns risetime pulse and 500 MHz bandwidth.

### Typical Performance Data (0, +5 V)

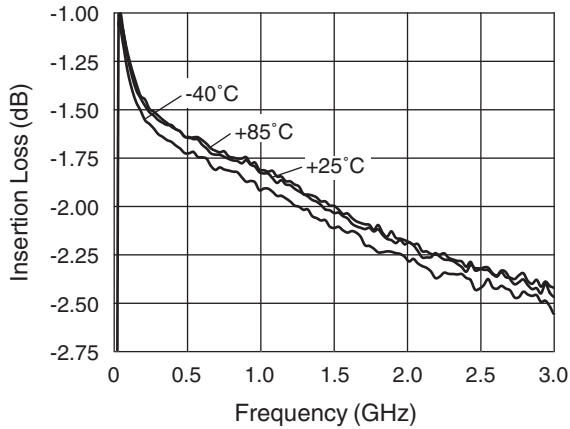

Insertion Loss vs. Frequency

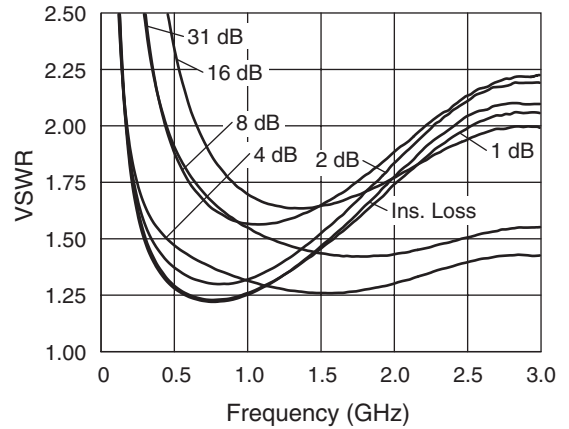

VSWR vs. Frequency (25°C)

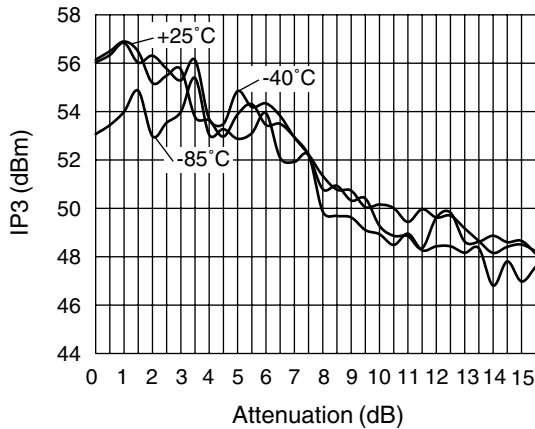

IP3 vs. Attenuation and Temperature (500 MHz)

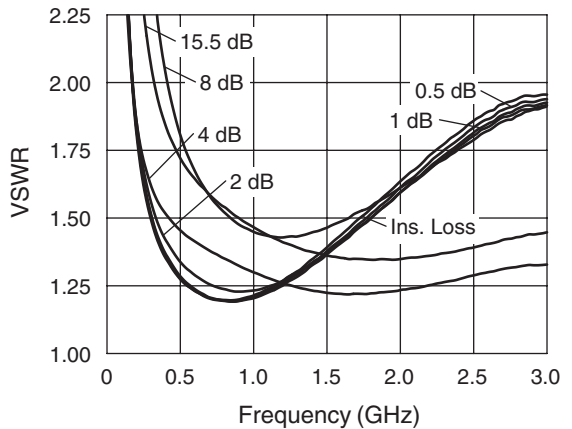

VSWR vs. Frequency (85°C)

### Compression Point vs. Attenuation, Voltage, and Temperature

Attenuation State	Control Voltage (V)	Input Power @ 1 dB Compression		
		+25°C (dBm)	+85°C (dBm)	-40°C (dBm)
Ins. Loss	5	30.7	30.1	30.1
0.5	5	31.6	31.1	31.1
1.0	5	31.0	30.5	30.2
2.0	5	31.4	30.9	30.5
4.0	5	36.8	36.8	36.8
8.0	5	27.4	33.8	27.1
15.5	5	32.9	31.2	33.3

Frequency = 0.5–2.5 GHz.

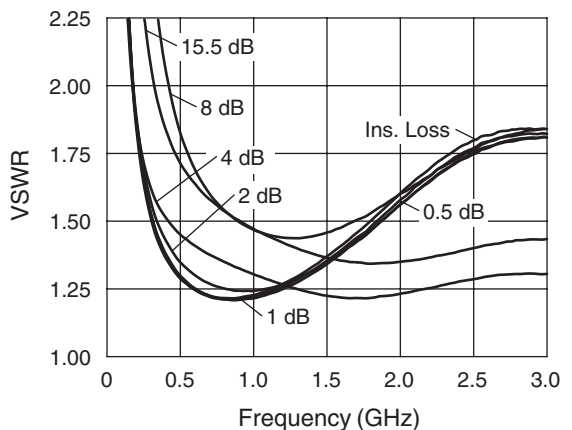

VSWR vs. Frequency (-40°C)

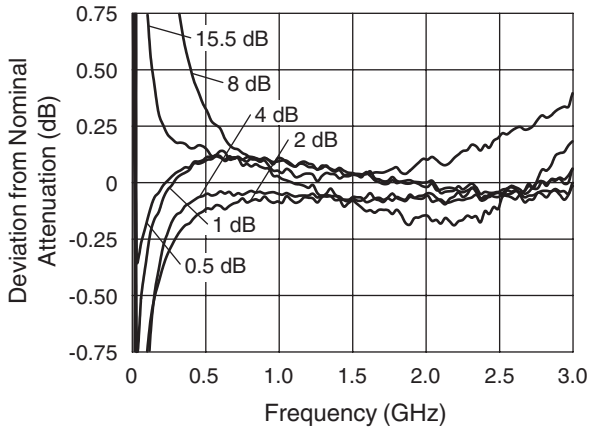

**Attenuation Accuracy vs. Frequency (25°C)**

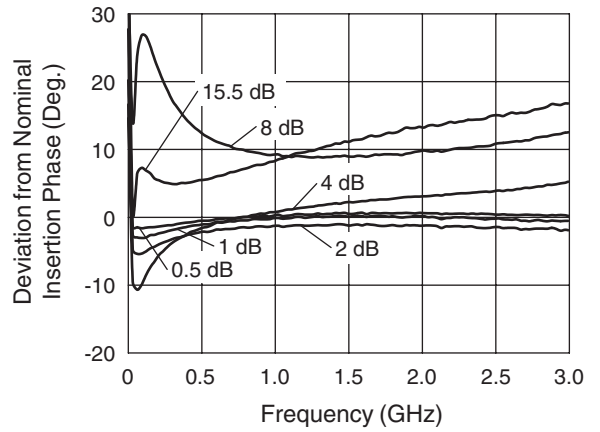

**Attenuation Phase Accuracy vs. Frequency (25°C)**

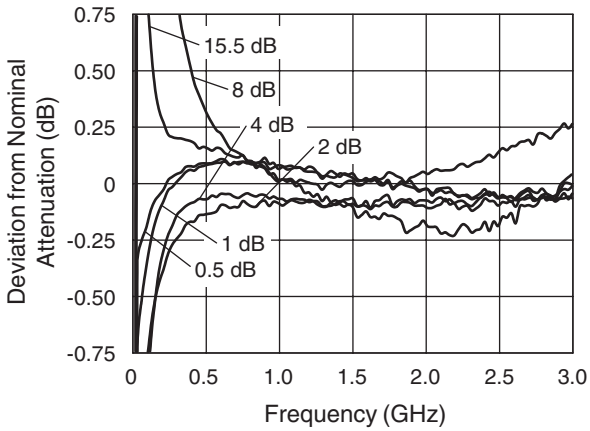

**Attenuation Accuracy vs. Frequency (85°C)**

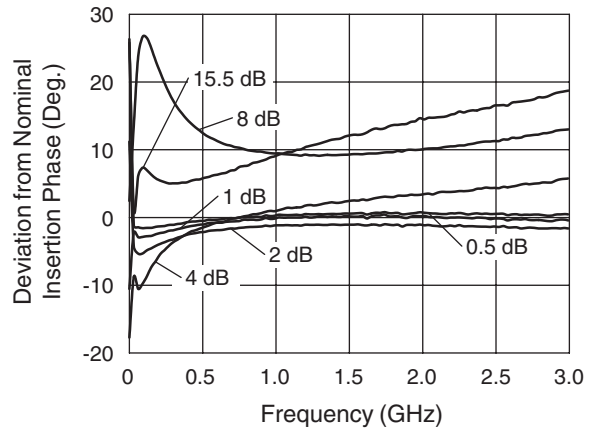

**Attenuation Phase Accuracy vs. Frequency (85°C)**

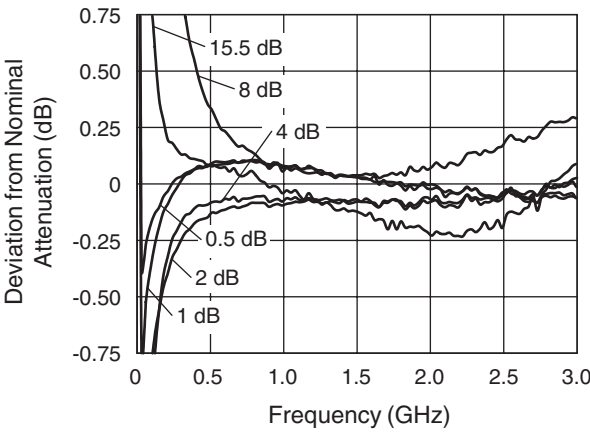

**Attenuation Accuracy vs. Frequency (-40°C)**

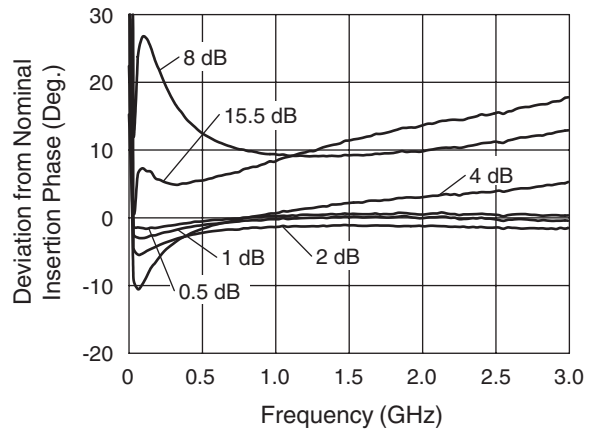

**Attenuation Phase Accuracy vs. Frequency (-40°C)**

**Typical Performance Data (0, +3 V)**

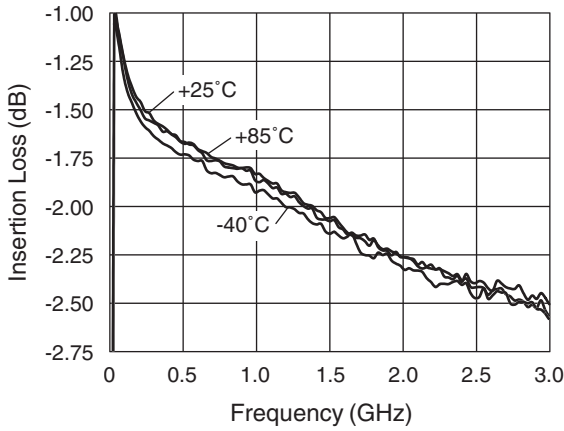

**Insertion Loss vs. Frequency**

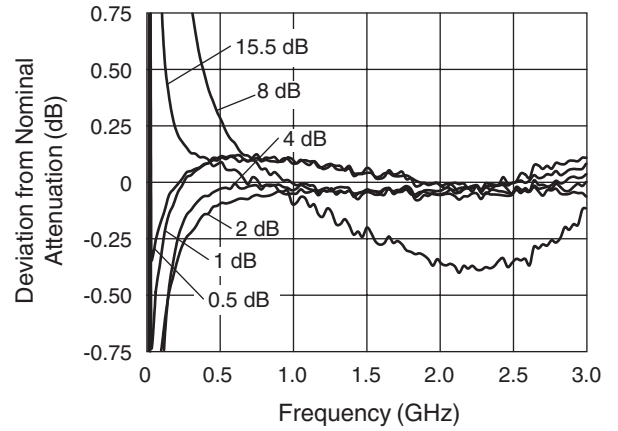

**Attenuation Accuracy vs. Frequency (25°C)**

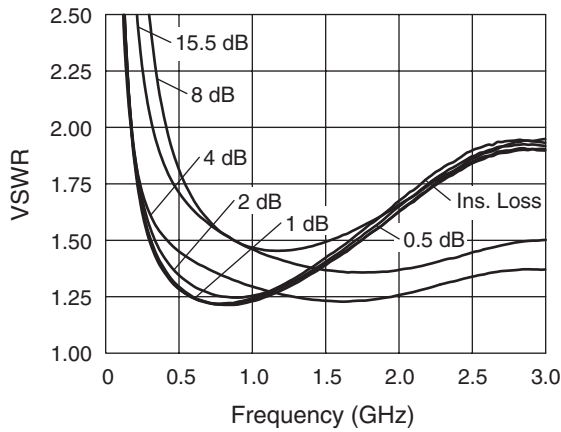

**VSWR vs. Frequency (25°C)**

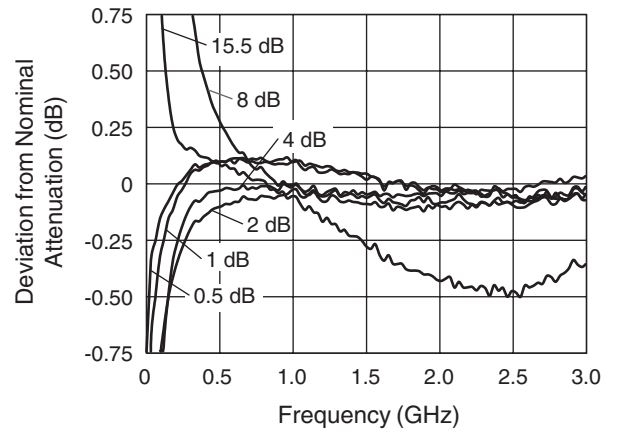

**Attenuation Accuracy vs. Frequency (85°C)**

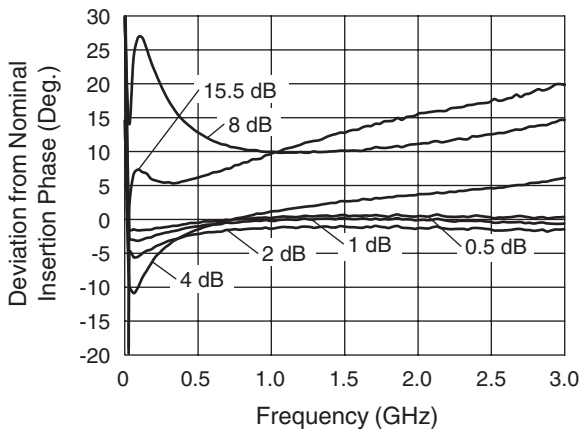

**Attenuation Phase Accuracy vs. Frequency (25°C)**

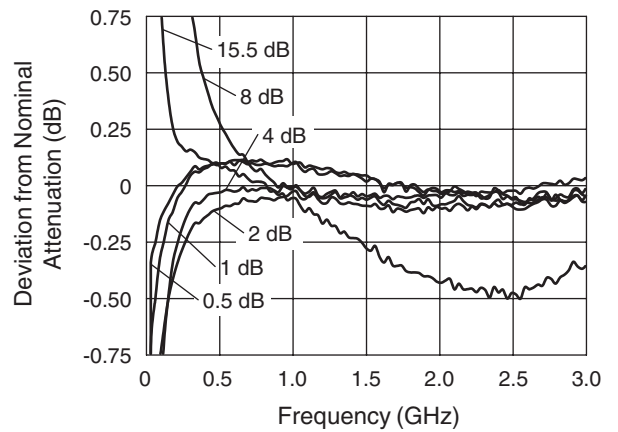

**Attenuation Accuracy vs. Frequency (-40°C)**

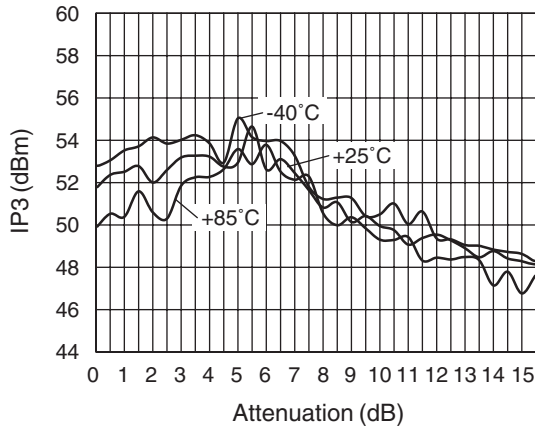

**IP3 vs. Attenuation and Temperature (500 MHz)**

**Compression Point vs. Attenuation, Voltage, and Temperature**

Attenuation State	Control Voltage (V)	Input Power @ 1 dB Compression		
		+25°C (dBm)	+85°C (dBm)	-40°C (dBm)
Ins. Loss	3	24.1	23.7	24.1
0.5	3	24.4	24.0	25.0
1.0	3	24.4	23.8	24.3
2.0	3	24.7	24.1	24.5
4.0	3	36.8	36.8	36.8
8.0	3	26.7	26.8	29.6
15.5	3	27.1	25.6	28.7

Frequency = 0.5–2.5 GHz.

**Truth Table**

V <sub>1</sub>	V <sub>2</sub>	V <sub>3</sub>	V <sub>4</sub>	V <sub>5</sub>	Attenuation J <sub>1</sub> –J <sub>2</sub>
8 dB	4 dB	2 dB	1 dB	0.5 dB	Reference I.L.
V <sub>High</sub>	V <sub>High</sub>	V <sub>High</sub>	V <sub>High</sub>	V <sub>High</sub>	0.5 dB
V <sub>High</sub>	V <sub>High</sub>	V <sub>High</sub>	V <sub>High</sub>	0	1 dB
V <sub>High</sub>	V <sub>High</sub>	0	V <sub>High</sub>	V <sub>High</sub>	2 dB
V <sub>High</sub>	0	V <sub>High</sub>	V <sub>High</sub>	V <sub>High</sub>	4 dB
0	V <sub>High</sub>	V <sub>High</sub>	V <sub>High</sub>	V <sub>High</sub>	8 dB
0	0	0	0	0	15.5 dB Max. Atten.

V<sub>High</sub> = +3 to +5 V (V<sub>S</sub> = V<sub>High</sub> ± 0.2 V).

**Pin Out**

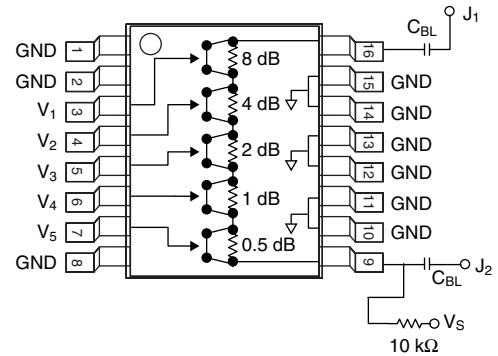

DC blocking capacitors (C<sub>BL</sub>) and biasing resistor must be supplied externally for positive voltage operation. C<sub>BL</sub> = 47 pF for operation >500 MHz.

**Absolute Maximum Ratings**

Characteristic	Value
RF Input Power	2 W > 500 MHz 0/8 V 0.75 W @ 50 MHz 0/8 V
Supply Voltage	+8 V
Control Voltage	-0.2 V, +8 V
Operating Temperature	-40°C to +85°C
Storage Temperature	-65°C to +150°C

Note: Exceeding these parameters may cause irreversible damage.