

3.2W, High-Efficiency, Low-EMI, Filterless, Class D Audio Amplifier

MAX9759

General Description

The MAX9759 mono class D, audio power amplifier provides class AB amplifier audio performance with the benefits of class D efficiency, eliminating the need for a heatsink and extending battery life. The MAX9759 delivers up to 3.2W of continuous power into a 4Ω load while offering greater than 90% efficiency. Maxim's next-generation, low-EMI modulation scheme allows the amplifier to operate without an external LC filter while still meeting FCC EMI-radiated emission levels.

The MAX9759 offers two modulation schemes: a fixed-frequency modulation (FFM) mode and a spread-spectrum modulation (SSM) mode. The SSM mode flattens the wideband spectral components, reducing EMI-radiated emissions due to the modulation frequency. Furthermore, the MAX9759 oscillator can be synchronized to an external clock through the SYNC input, allowing the switching frequency to range from 1000kHz to 1600kHz. The SYNC input and SYNC_OUT output of the MAX9759 allow multiple Maxim class D amplifiers to be cascaded and frequency locked, minimizing interference due to clock intermodulation. The MAX9759 utilizes fully differential input amplifiers, a full-bridged output, comprehensive click-and-pop suppression, and features four selectable gain settings (6dB, 12dB, 18dB, 24dB).

The MAX9759 features high 81dB PSRR, low 0.02% THD+N, and SNR in excess of 90dB. Short-circuit and thermal-overload protection prevents damage to the device during a fault condition. The MAX9759 operates from a single 5V supply, consumes 8.4mA of supply current, and is available in a 16-pin thin QFN package (4mm x 4mm x 0.8mm) and a 16-pin TSSOP package. The MAX9759 is fully specified over the extended -40°C to +85°C temperature range.

Applications

Cell Phones/PDAs
 Notebook PCs
 Portable DVD Players
 Flat-Panel PC Monitors
 LCD TVs
 LCD Projectors

Pin Configurations appear at end of data sheet.



Maxim Integrated Products 1

For pricing, delivery, and ordering information, please contact Maxim/Dallas Direct! at

888.629.4642, or visit Maxim's website at www.maxim-ic.com.

Features

- ◆ 3.2W into 4Ω Load (THD+N = 10%)
- ◆ Filterless Amplifier Passes FCC Radiated Emissions Standards with 7.6cm of Cable
- ◆ 92% Efficiency
- ◆ High PSRR (81dB at 1kHz)
- ◆ Low 0.02% THD+N
- ◆ External Clock Synchronization for Multiple, Cascaded Maxim Class D Amplifiers
- ◆ 3.0V to 5.5V Single-Supply Operation
- ◆ Pin-Selectable Gain (6dB, 12dB, 18dB, 24dB)
- ◆ Integrated Click-and-Pop Suppression
- ◆ Low Quiescent Current (8.4mA)
- ◆ Low-Power Shutdown Mode (10μA)
- ◆ Mute Function
- ◆ Short-Circuit and Thermal-Overload Protection
- ◆ Available in Thermally Efficient Packages
 - 16-Pin TQFN (4mm x 4mm x 0.8mm)
 - 16-Pin TSSOP

Ordering Information

PART	TEMP RANGE	PIN-PACKAGE
MAX9759ETE+	-40°C to +85°C	16 TQFN-EP*
MAX9759EUE+	-40°C to +85°C	16 TSSOP

+Denotes lead-free package.

*EP = Exposed paddle.

Simplified Block Diagram

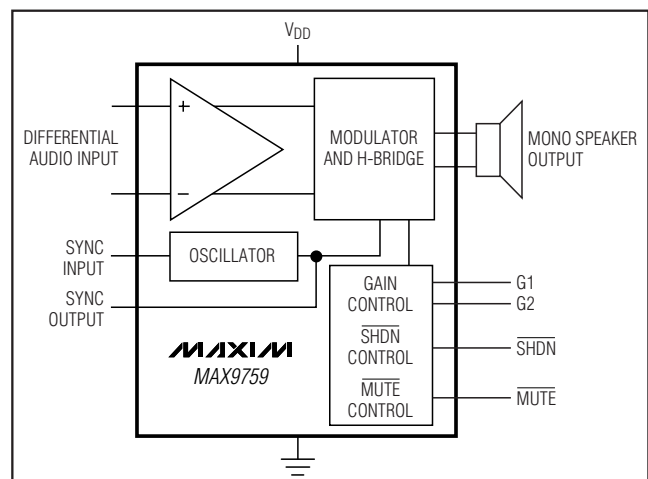

3.2W, High-Efficiency, Low-EMI, Filterless, Class D Audio Amplifier

MAX9759

ABSOLUTE MAXIMUM RATINGS

V_{DD} to GND6V
 PV_{DD} to PGND6V
 GND to PGND-0.3V to +0.3V
 All Other Pins to GND.....-0.3V to (V_{DD} + 0.3V)
 Continuous Current Into/Out of PV_{DD}/PGND/OUT+/OUT-....1.7A
 Duration of OUT+ or OUT- Short Circuit to
 V_{DD}/GND/PV_{DD}/PGND.....Continuous
 Duration of Short Circuit Between OUT+ and OUT- ..Continuous

Continuous Power Dissipation (T_A = +70°C)
 16-Pin TQFN (derate 16.9mW/°C above +70°C)1349.1mW
 16-Pin TSSOP (derate 9.4mW/°C above +70°C)754.7mW
 Junction Temperature+150°C
 Operating Temperature Range-40°C to +85°C
 Storage Temperature Range.....-65°C to +150°C
 Lead Temperature (soldering, 10s).....+300°C
 ESD Protection (+IBM).....±2kV

Stresses beyond those listed under "Absolute Maximum Ratings" may cause permanent damage to the device. These are stress ratings only, and functional operation of the device at these or any other conditions beyond those indicated in the operational sections of the specifications is not implied. Exposure to absolute maximum rating conditions for extended periods may affect device reliability.

ELECTRICAL CHARACTERISTICS (V_{DD} = 5.0V)

(V_{DD} = PV_{DD} = $\overline{\text{SHDN}}$ = $\overline{\text{MUTE}}$ = 5V, GND = PGND = 0V, SYNC = 0V (FFM). Gain = 12dB (G1 = 0, G2 = 1). Speaker load resistor (R_L) connected between OUT+ and OUT-, unless otherwise noted, R_L = ∞, T_A = T_{MIN} to T_{MAX}, unless otherwise noted. Typical values are at T_A = +25°C.) (Notes 1, 2)

PARAMETER	SYMBOL	CONDITIONS	MIN	TYP	MAX	UNITS	
GENERAL							
Supply Voltage Range	V _{DD}	Inferred from PSRR test	3.0		5.5	V	
Quiescent Current	I _{DD}	No load		8.4	12	mA	
Mute Current	I _{MUTE}	V _{MUTE} = 0V		5.5	8	mA	
Shutdown Current	I _{DD(SHDN)}	V _{SHDN} = 0V		0.1	10	μA	
Shutdown to Full Operation	t _{SON}			40		ms	
Mute to Full Operation	t _{MUTE}			40		ms	
Common-Mode Rejection Ratio	CMRR	f = 1kHz, input referred, V _{IN} = 200mV _{P-P}		67		dB	
Input DC Bias Voltage	V _{CM}		1.3	1.5	1.7	V	
Input Resistance	R _{IN}	Gain = +24dB	14	20	26	kΩ	
		Gain = +18dB	25	36	47		
		Gain = +12dB	40	60	80		
		Gain = +6dB	60	90	120		
Voltage Gain	A _V	G1 = 0, G2 = 0	+22	+24	+26	dB	
		G1 = 1, G2 = 0	+16	+18	+20		
		G1 = 0, G2 = 1	+10	+12	+14		
		G1 = 1, G2 = 1	+4	+6	+8		
Output Offset Voltage	V _{OS}	T _A = +25°C		±10	±50	mV	
Power-Supply Rejection Ratio (Note 3)	PSRR	V _{DD} = 4.5V to 5.5V	62	90		dB	
		200mV _{P-P} ripple	f _{RIPPLE} = 217Hz		79		
			f _{RIPPLE} = 1kHz		81		
			f _{RIPPLE} = 20kHz		70		

3.2W, High Efficiency, Low-EMI, Filterless, Class D Audio Amplifier

MAX9759

ELECTRICAL CHARACTERISTICS (V_{DD} = 5.0V) (continued)

(V_{DD} = P_{VDD} = $\overline{\text{SHDN}}$ = $\overline{\text{MUTE}}$ = 5V, GND = PGND = 0V, SYNC = 0V (FFM). Gain = 12dB (G1 = 0, G2 = 1). Speaker load resistor (R_L) connected between OUT+ and OUT-, unless otherwise noted, R_L = ∞, T_A = T_{MIN} to T_{MAX}, unless otherwise noted. Typical values are at T_A = +25°C.) (Notes 1, 2)

PARAMETER	SYMBOL	CONDITIONS		MIN	TYP	MAX	UNITS
Output Power	P _{OUT}	THD+N = 1%	R _L = 3Ω		3.4		W
			R _L = 4Ω		2.6		
			R _L = 8Ω		1.4		
		THD+N = 10%	R _L = 3Ω		4.3		
			R _L = 4Ω		3.2		
			R _L = 8Ω		1.8		
Total Harmonic Distortion Plus Noise	THD+N	f _{IN} = 1kHz, either FFM or SSM, P _{OUT} = 1W	R _L = 3Ω		0.08		%
			R _L = 4Ω		0.05		
			R _L = 8Ω		0.02		
Signal-to-Noise Ratio	SNR	P _{OUT} = 1W, R _L = 8Ω	BW = 22Hz to 22kHz	FFM	93		dB
				SSM	89		
			A-weighted	FFM	96		
				SSM	92		
Oscillator Frequency	f _{OSC}	SYNC = GND (FFM mode)		1000	1100	1200	kHz
		SYNC = FLOAT (FFM mode)		1102	1500	1837	
		SYNC = V _{DD} (SSM mode)		1200 ±70			
SYNC Frequency Lock Range		TTL-compatible clock input		1000		1600	kHz
Click-and-Pop Level	K _{CP}	Peak voltage, A-weighted, 32 samples per second (Notes 3, 4)	Into shutdown		-50		dB
			Out of shutdown		-57		
Efficiency	η	P _{OUT} = 1W, f _{IN} = 1kHz, R _L = 8Ω in series with 68μH			92		%
DIGITAL INPUTS ($\overline{\text{SHDN}}$, $\overline{\text{MUTE}}$, G1, G2, SYNC)							
SYNC, G1, G2 Input Voltage High	V _{INH}			V _{DD} × 0.9			V
SYNC, G1, G2 Input Voltage Low	V _{INL}				V _{DD} × 0.1		V
$\overline{\text{SHDN}}$, $\overline{\text{MUTE}}$ Voltage High	V _{INH}			2			V
$\overline{\text{SHDN}}$, $\overline{\text{MUTE}}$ Voltage Low	V _{INL}				0.8		V
SYNC Input Resistance					200		kΩ
SYNC Input Current						±35	μA
$\overline{\text{SHDN}}$, $\overline{\text{MUTE}}$, G1, G2 Input Current						±1	μA
SYNC Capacitance					10		pF
DIGITAL OUTPUTS (SYNC_OUT)							
Output Voltage High	V _{OH}	I _{OH} = 3mA		2.4			V
Output Voltage Low	V _{OL}	I _{OL} = 3mA				0.4	V
SYNC_OUT Capacitive Drive		TTL-compatible clock output			100		pF

3.2W, High-Efficiency, Low-EMI, Filterless, Class D Audio Amplifier

MAX9759

ELECTRICAL CHARACTERISTICS (V_{DD} = 3.3V)

(V_{DD} = P_{VDD} = S_{HDN} = M_{UTE} = 3.3V, G_{ND} = P_{GND} = 0V, S_{YNC} = G_{ND} (FFM). Gain = 12dB (G₁ = 0, G₂ = 1). Speaker load resistor (R_L) connected between OUT+ and OUT-, unless otherwise noted. R_L = ∞, T_A = T_{MIN} to T_{MAX}, unless otherwise noted. Typical values are at T_A = +25°C.) (Notes 1, 2)

PARAMETER	SYMBOL	CONDITIONS	MIN	TYP	MAX	UNITS	
Quiescent Current	I _{DD}			6		mA	
Mute Current	I _{MUTE}	V _{MUTE} = 0V		5		A	
Shutdown Current	I _{SHDN}	V _{SHDN} = 0V		0.1		μA	
Common-Mode Rejection Ratio	CMRR	f = 1kHz, input referred		67		dB	
Power-Supply Rejection Ratio	PSRR	V _{DD} = 3.0V to 5.5V	50	72		dB	
		200mV _{p-p} ripple	f _{RIPPLE} = 217Hz		79		dB
			f _{RIPPLE} = 1kHz		81		
			f _{RIPPLE} = 20kHz		70		
Output Power	P _{OUT}	THD+N = 1%	R _L = 3Ω		1.5	W	
			R _L = 4Ω		1.1		
			R _L = 8Ω		0.65		
		THD+N = 10%	R _L = 3Ω		1.8		
			R _L = 4Ω		1.3		
			R _L = 8Ω		0.78		
Total Harmonic Distortion Plus Noise	THD+N	f = 1kHz, either FFM or SSM, P _{OUT} = 500mW	R _L = 3Ω		0.06	%	
			R _L = 4Ω		0.04		
			R _L = 8Ω		0.02		
Signal-to-Noise Ratio	SNR	P _{OUT} = 500mW, R _L = 8Ω	BW = 22Hz to 22kHz	FFM		93	dB
				SSM		89	
			A-weighted	FFM		96	
				SSM		92	

Note 1: All devices are 100% production tested at +25°C. All temperature limits are guaranteed by design.

Note 2: Testing performed with a resistive load in series with an inductor to simulate an actual speaker load. For R_L = 4Ω, L = 33μH. For R_L = 8Ω, L = 68μH.

Note 3: Inputs AC-coupled to GND.

Note 4: Testing performed with 8Ω resistive load in series with a 68μH inductive load across BTL outputs. Mode transitions are controlled by the SHDN pin.

3.2W, High-Efficiency, Low-EMI, Filterless, Class D Audio Amplifier

Typical Operating Characteristics

($V_{DD} = PV_{DD} = \overline{SHDN} = \overline{MUTE} = 5V$, $GND = PGND = 0V$, $SYNC = V_{DD}$ (SSM), unless otherwise noted. Gain = 12dB ($G1 = 0$, $G2 = 1$). THD+N measurement bandwidth: 22Hz to 22kHz. Typical values are at $T_A = +25^\circ C$.) (See *Typical Operating Circuit*)

MAX9759

TOTAL HARMONIC DISTORTION PLUS NOISE vs. FREQUENCY

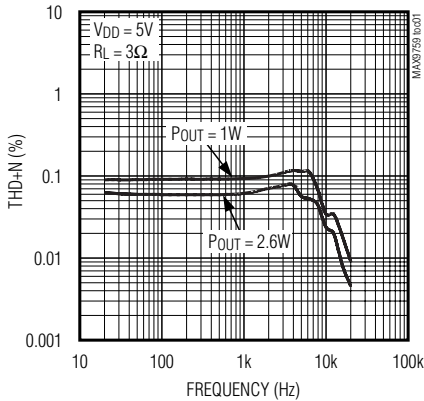

TOTAL HARMONIC DISTORTION PLUS NOISE vs. FREQUENCY

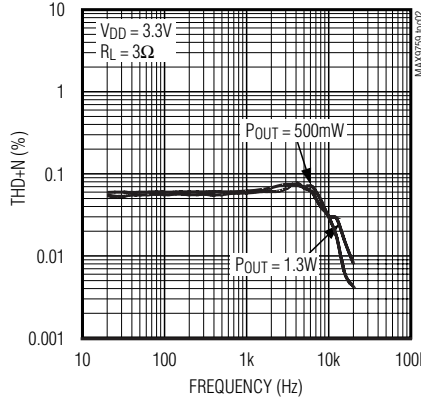

TOTAL HARMONIC DISTORTION PLUS NOISE vs. FREQUENCY

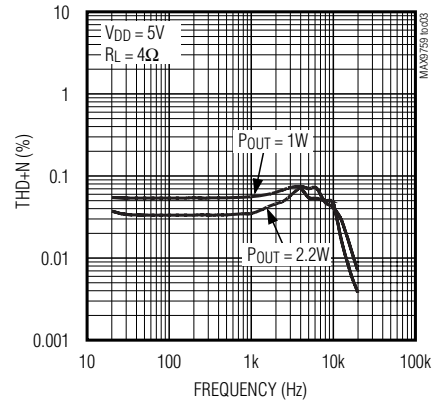

TOTAL HARMONIC DISTORTION PLUS NOISE vs. FREQUENCY

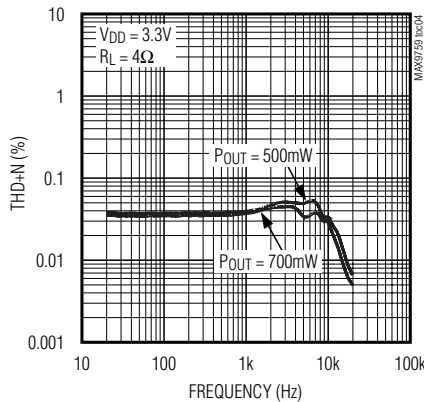

TOTAL HARMONIC DISTORTION PLUS NOISE vs. FREQUENCY

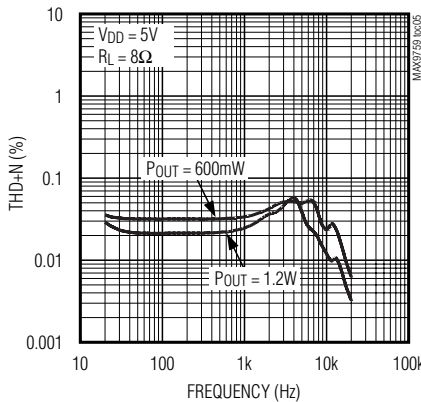

TOTAL HARMONIC DISTORTION PLUS NOISE vs. FREQUENCY

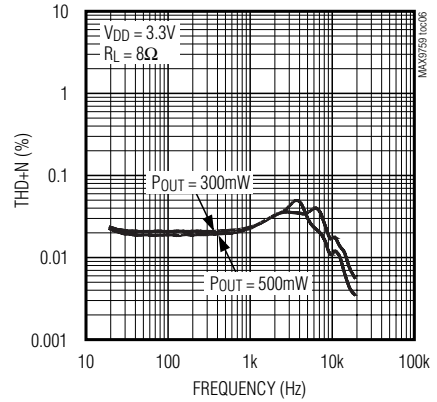

TOTAL HARMONIC DISTORTION PLUS NOISE vs. FREQUENCY

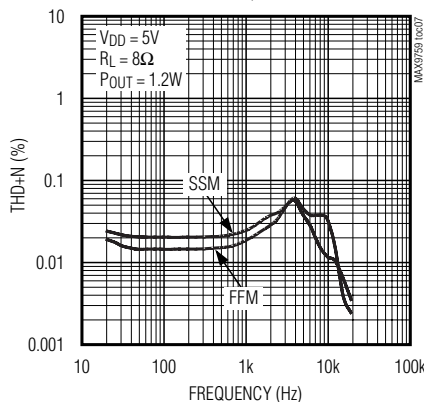

TOTAL HARMONIC DISTORTION PLUS NOISE vs. OUTPUT POWER

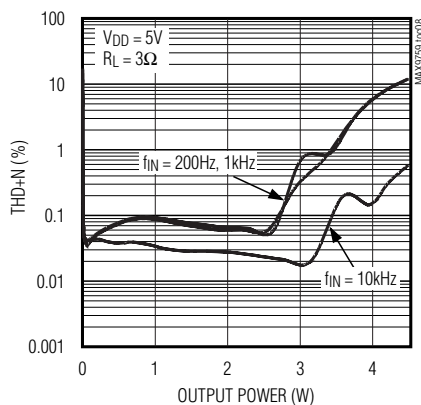

TOTAL HARMONIC DISTORTION PLUS NOISE vs. OUTPUT POWER

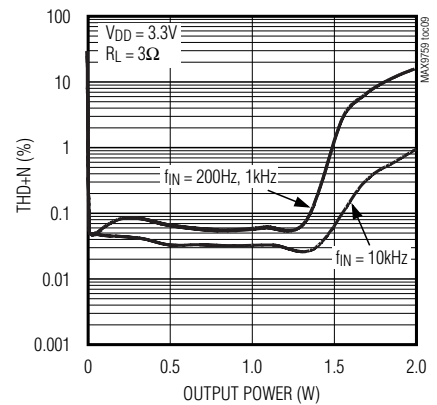

3.2W, High-Efficiency, Low-EMI, Filterless, Class D Audio Amplifier

Typical Operating Characteristics (continued)

($V_{DD} = PV_{DD} = SHDN = MUTE = 5V$, $GND = PGND = 0V$, $SYNC = V_{DD}$ (SSM), unless otherwise noted. Gain = 12dB ($G1 = 0$, $G2 = 1$). THD+N measurement bandwidth: 22Hz to 22kHz. Typical values are at $T_A = +25^\circ C$.) (See *Typical Operating Circuit*)

MAX9759

TOTAL HARMONIC DISTORTION PLUS NOISE vs. OUTPUT POWER

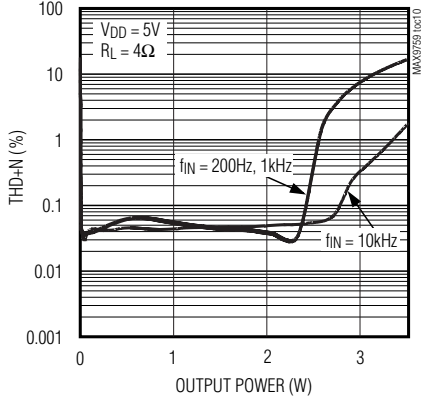

TOTAL HARMONIC DISTORTION PLUS NOISE vs. OUTPUT POWER

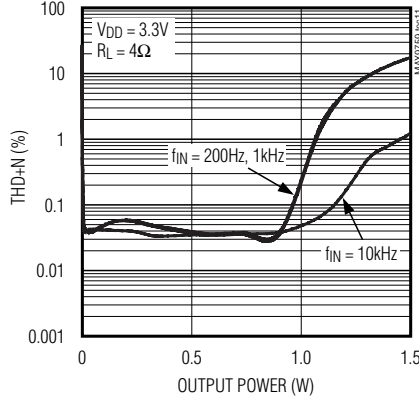

TOTAL HARMONIC DISTORTION PLUS NOISE vs. OUTPUT POWER

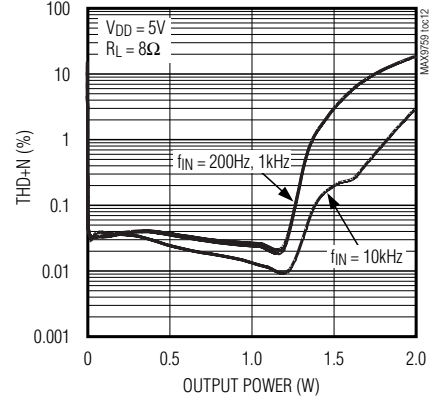

TOTAL HARMONIC DISTORTION PLUS NOISE vs. OUTPUT POWER

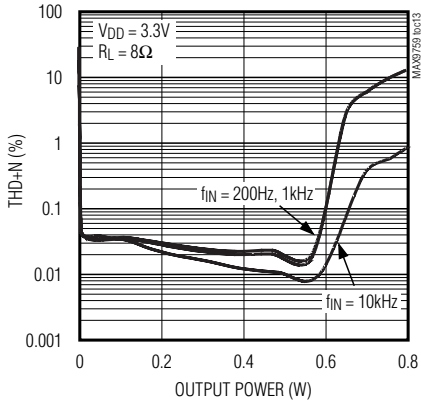

TOTAL HARMONIC DISTORTION PLUS NOISE vs. OUTPUT POWER

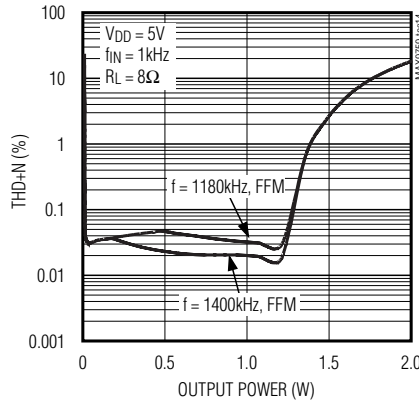

EFFICIENCY vs. OUTPUT POWER

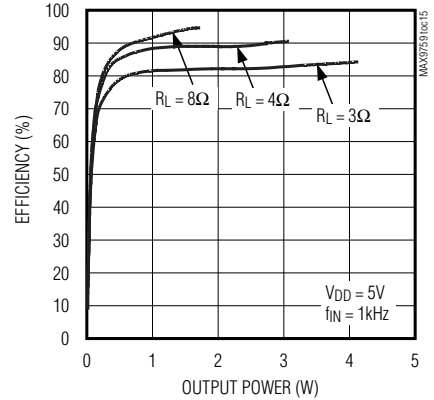

EFFICIENCY vs. OUTPUT POWER

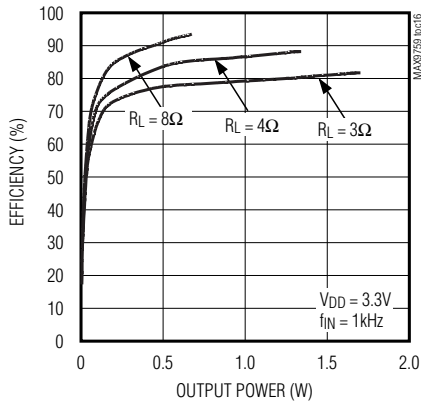

EFFICIENCY vs. SUPPLY VOLTAGE

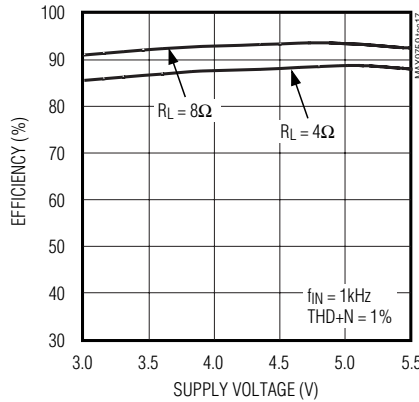

OUTPUT POWER vs. SUPPLY VOLTAGE

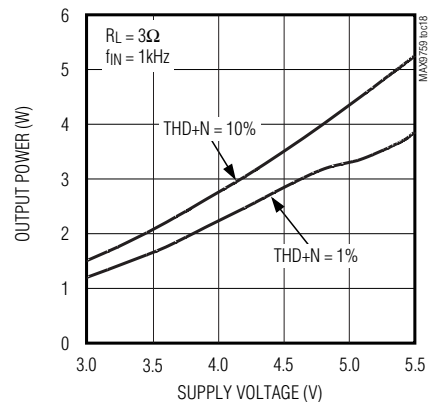

3.2W, High Efficiency, Low-EMI, Filterless, Class D Audio Amplifier

MAX9759

Typical Operating Characteristics (continued)

($V_{DD} = PV_{DD} = \overline{SHDN} = \overline{MUTE} = 5V$, $GND = PGND = 0V$, $SYNC = V_{DD}$ (SSM), unless otherwise noted. Gain = 12dB ($G1 = 0$, $G2 = 1$). THD+N measurement bandwidth: 22Hz to 22kHz. Typical values are at $T_A = +25^\circ C$.) (See *Typical Operating Circuit*)

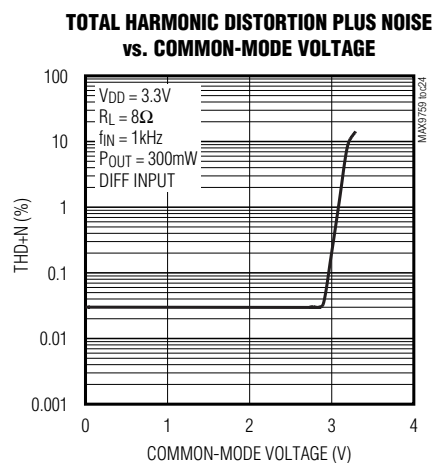
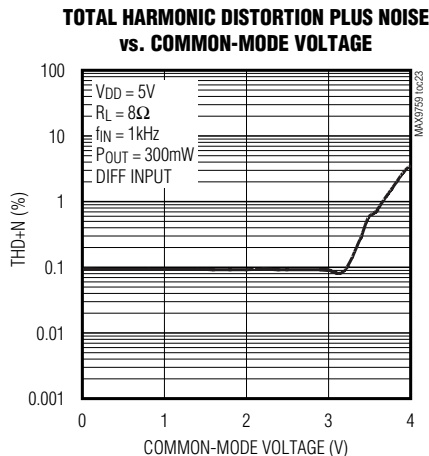
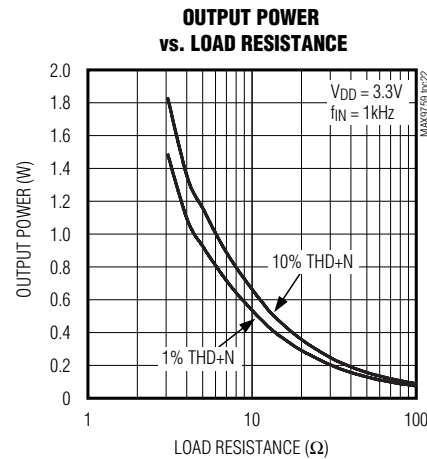
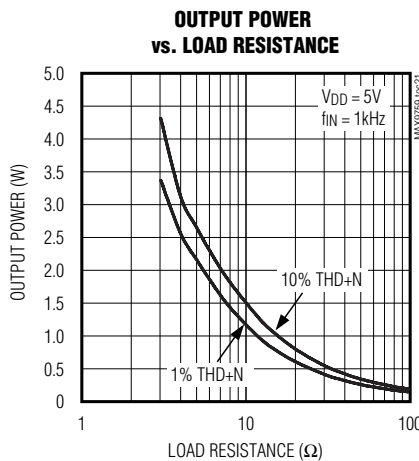
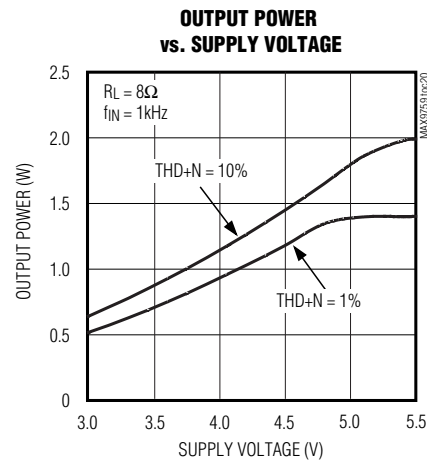
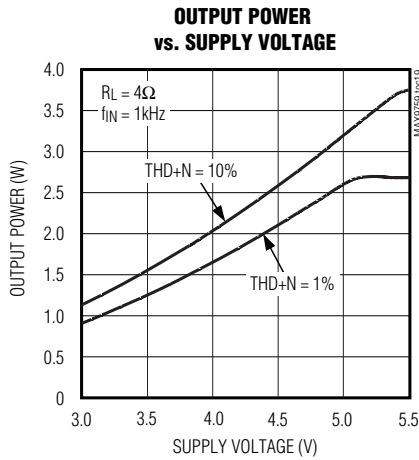

3.2W, High-Efficiency, Low-EMI, Filterless, Class D Audio Amplifier

MAX9759

Typical Operating Characteristics (continued)

($V_{DD} = PV_{DD} = \overline{SHDN} = \overline{MUTE} = 5V$, $GND = PGND = 0V$, $SYNC = V_{DD}$ (SSM), unless otherwise noted. Gain = 12dB ($G1 = 0$, $G2 = 1$). THD+N measurement bandwidth: 22Hz to 22kHz. Typical values are at $T_A = +25^\circ C$.) (See *Typical Operating Circuit*)

COMMON-MODE REJECTION RATIO vs. FREQUENCY

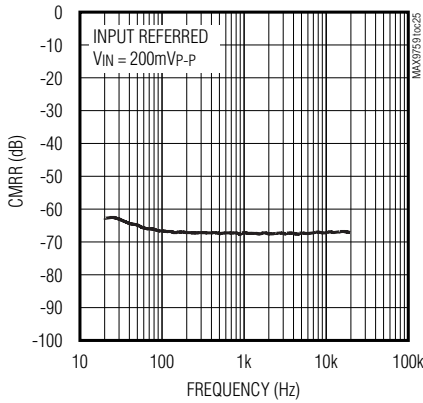

POWER-SUPPLY REJECTION RATIO vs. FREQUENCY

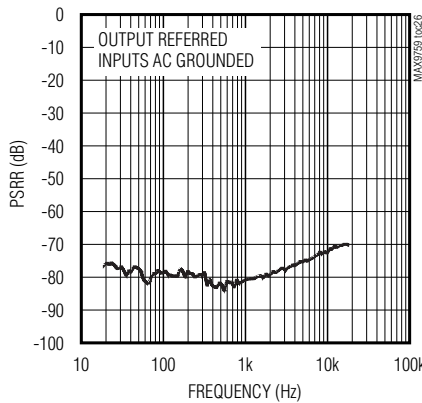

OUTPUT FREQUENCY SPECTRUM

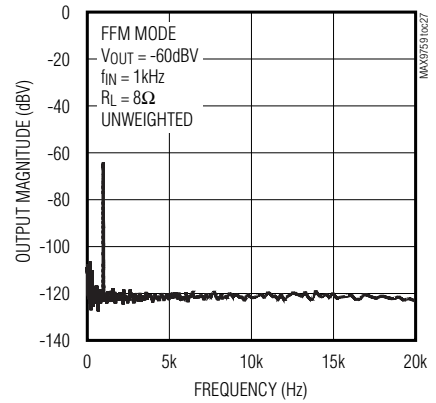

OUTPUT FREQUENCY SPECTRUM

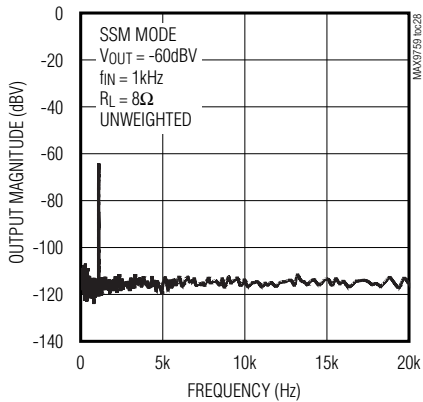

WIDEBAND OUTPUT SPECTRUM (FFM MODE)

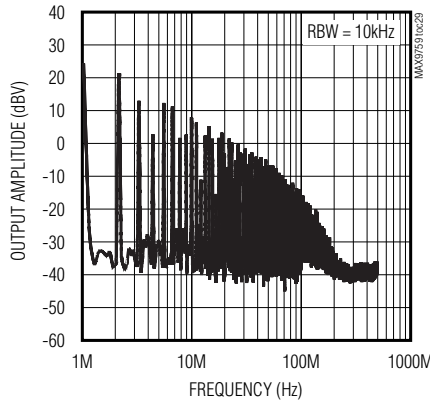

WIDEBAND OUTPUT SPECTRUM (SSM MODE)

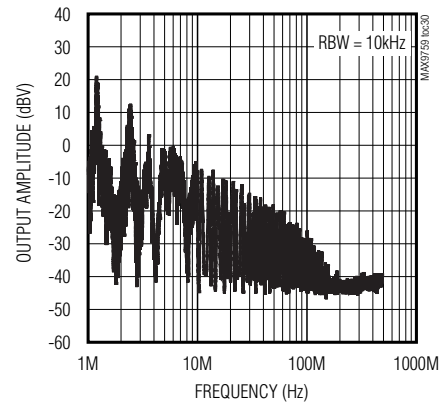

SHUTDOWN RESPONSE

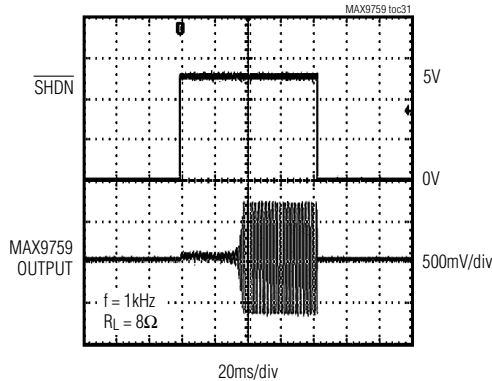

MUTE RESPONSE

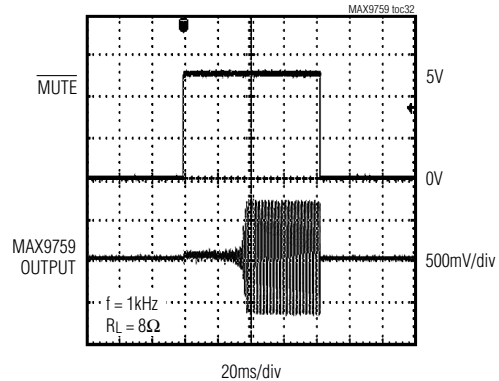

3.2W, High-Efficiency, Low-EMI, Filterless, Class D Audio Amplifier

MAX9759

Typical Operating Characteristics (continued)

($V_{DD} = PV_{DD} = \overline{SHDN} = \overline{MUTE} = 5V$, $GND = PGND = 0V$, $SYNC = V_{DD}$ (SSM), unless otherwise noted. Gain = 12dB ($G1 = 0$, $G2 = 1$). THD+N measurement bandwidth: 22Hz to 22kHz. Typical values are at $T_A = +25^\circ C$.) (See *Typical Operating Circuit*)

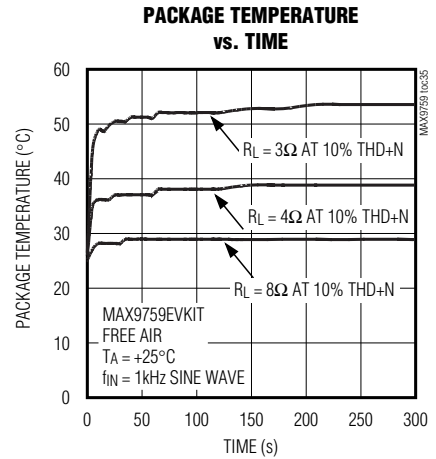
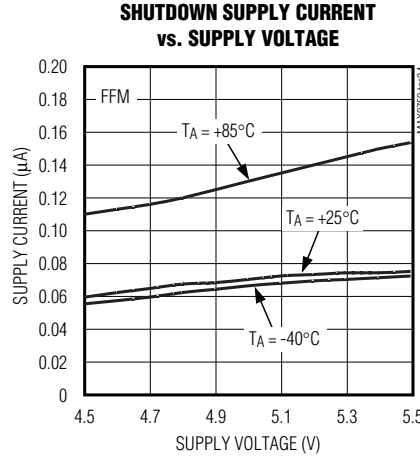
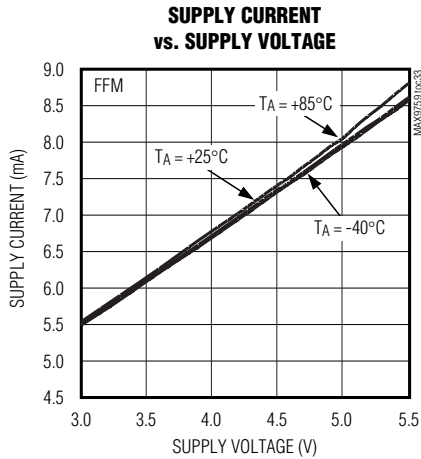

Typical Operating Circuit/Functional Diagram

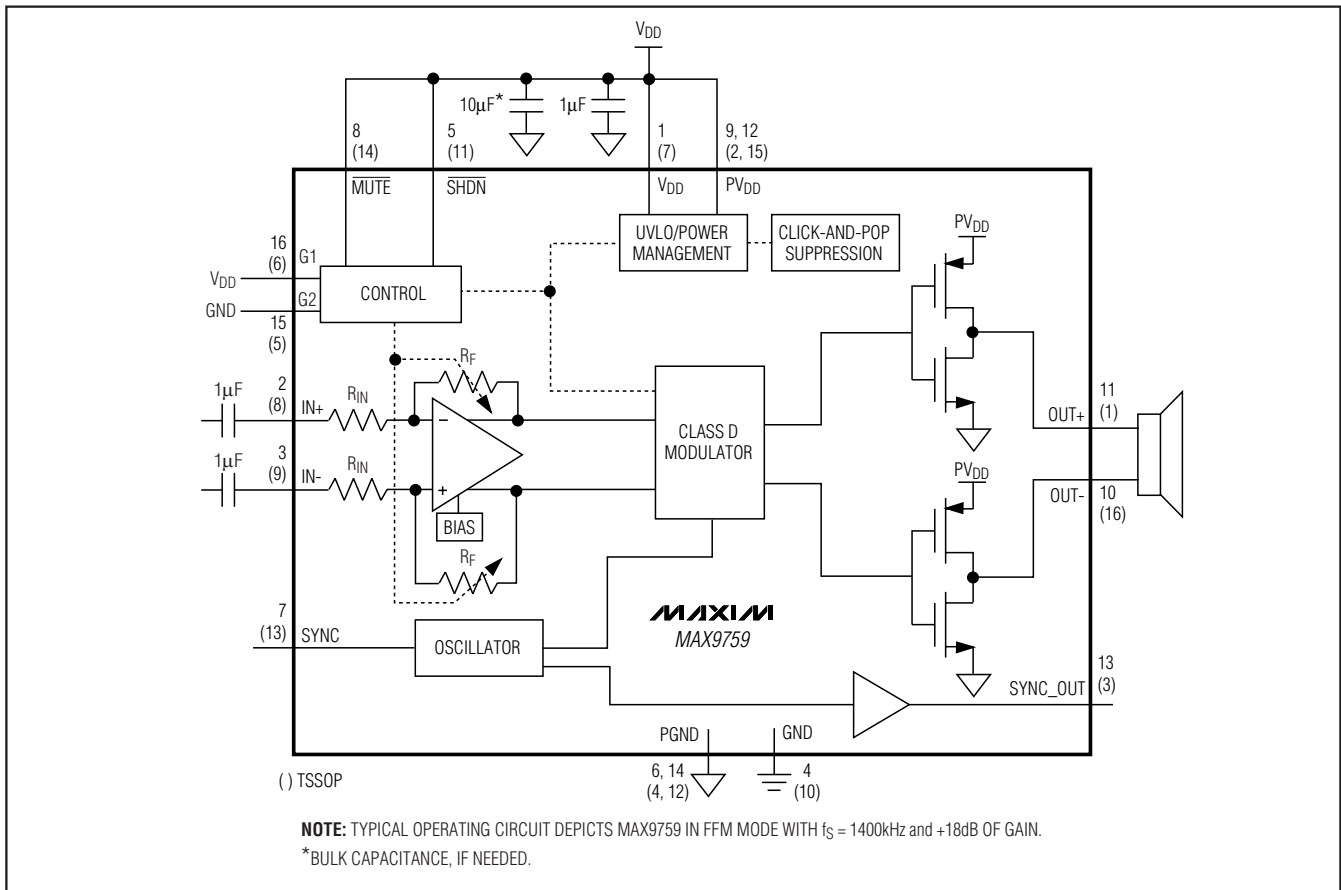

3.2W, High-Efficiency, Low-EMI, Filterless, Class D Audio Amplifier

MAX9759

Pin Description

PIN		NAME	FUNCTION
TQFN	TSSOP		
1	7	V _{DD}	Analog Power Supply. Bypass to GND with a 1μF ceramic capacitor.
2	8	IN+	Noninverting Audio Input
3	9	IN-	Inverting Audio Input
4	10	GND	Analog Ground
5	11	$\overline{\text{SHDN}}$	Active-Low Shutdown Input. Drive $\overline{\text{SHDN}}$ low to shut down the MAX9759. Connect to V _{DD} for normal operation.
6, 14	4, 12	PGND	Power Ground
7	13	SYNC	Frequency Select and External Clock Input: SYNC = GND: Fixed-frequency mode with f _S = 1100kHz. SYNC = FLOAT: Fixed-frequency mode with f _S = 1500kHz. SYNC = V _{DD} : Spread-spectrum mode with f _S = 1200kHz ±70kHz. SYNC = Clocked: Fixed-frequency mode with f _S = external clock frequency.
8	14	$\overline{\text{MUTE}}$	Active-Low Mute Function. Drive $\overline{\text{MUTE}}$ low to disable the H-bridge outputs. Connect to V _{DD} for normal operation.
9, 12	2, 15	PV _{DD}	H-Bridge Power Supply. Bypass to PGND with a 10μF ceramic capacitor.
10	16	OUT-	Negative Speaker Output
11	1	OUT+	Positive Speaker Output
13	3	SYNC_OUT	Internal Clock Output. Connect SYNC_OUT to the clock input of cascaded Maxim class D amplifiers. Float SYNC_OUT if unused.
15	5	G2	Gain Control 2 (See the <i>Gain Selection</i> Section)
16	6	G1	Gain Control 1 (See the <i>Gain Selection</i> Section)
EP	EP	EP	Exposed Paddle. Can be left floating or tied to GND.

Detailed Description

Operating Modes

The MAX9759 filterless, Class D audio power amplifier features several improvements to switch-mode amplifier technology. The MAX9759 offers Class AB performance with Class D efficiency, while occupying minimal board space. A unique modulation scheme, synchronizable switching frequency, and SSM mode create a compact, flexible, low-noise, efficient audio power amplifier. The differential input architecture reduces common-mode noise pickup, and can be used without input-coupling capacitors. The device can also be configured as a single-ended input amplifier.

Comparators monitor the MAX9759 inputs and compare the complementary input voltages to the sawtooth waveform. The comparators trip when the input magnitude of the sawtooth exceeds their corresponding input voltage. Both comparators reset at a fixed time after the rising edge of the second comparator trip point, gener-

ating a minimum-width pulse t_{ON(MIN)} at the output of the second comparator (Figure 1). As the input voltage increases or decreases, the duration of the pulse at one output increases (the first comparator to trip) while the other output pulse duration remains at t_{ON(MIN)}. This causes the net voltage across the speaker (V_{OUT+} - V_{OUT-}) to change.

Fixed-Frequency Modulation (FFM) Mode

The MAX9759 features two FFM modes. The FFM modes are selected by setting SYNC = GND for a 1.1MHz switching frequency, and SYNC = FLOAT for a 1.5MHz switching frequency. In FFM mode, the frequency spectrum of the class D output consists of the fundamental switching frequency and its associated harmonics (see the Wideband FFT graph in the *Typical Operating Characteristics*). The MAX9759 allows the switching frequency to be changed, should the frequency of one or more of the harmonics fall in a sensitive band. This can be done at any time and does not affect audio reproduction.

3.2W, High Efficiency, Low-EMI, Filterless, Class D Audio Amplifier

MAX9759

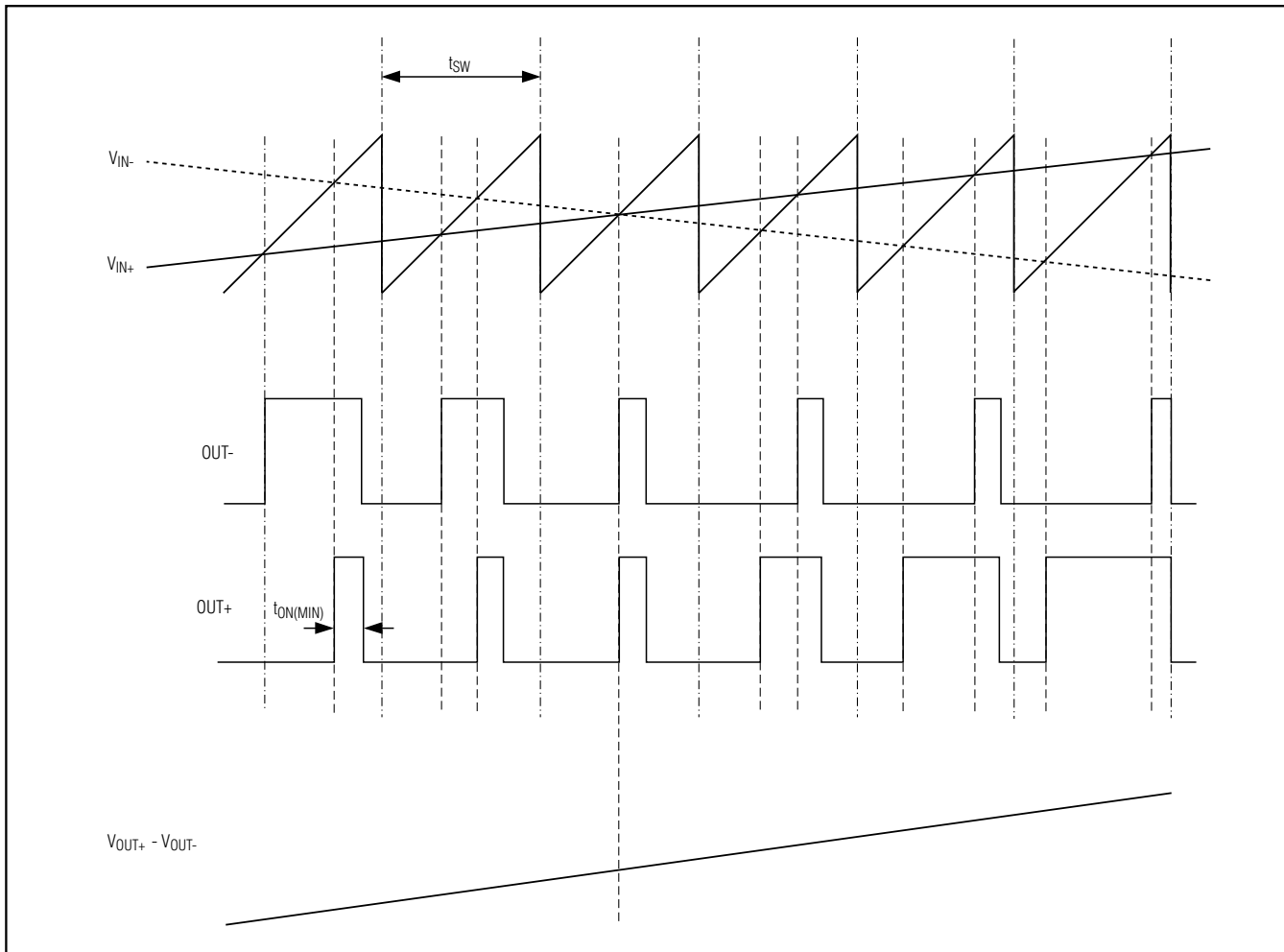

Figure 1. MAX9759 Outputs with an Input Signal Applied

Table 1. Operating Modes

SYNC INPUT	MODE
GND	FFM with $f_S = 1100\text{kHz}$
FLOAT	FFM with $f_S = 1500\text{kHz}$
V_{DD}	SSM with $f_S = 1200\text{kHz} \pm 70\text{kHz}$
Clocked	FFM with $f_S = \text{external clock frequency}$

Spread-Spectrum Modulation (SSM) Mode

The MAX9759 features a unique, patented spread-spectrum mode that reduces peak component energy in the wideband spectrum, improving EMI emissions that may be radiated by the speaker and cables by 5dB.

Proprietary techniques ensure that the cycle-to-cycle variation of the switching period does not degrade audio reproduction or efficiency (see the *Typical Operating Characteristics*). Select SSM mode by setting SYNC = V_{DD} . In SSM mode, the switching frequency varies by $\pm 70\text{kHz}$ around the center frequency (1.2MHz). The modulation scheme remains the same, but the period of the sawtooth waveform changes from cycle to cycle (Figure 2). Instead of a large amount of spectral energy present at multiples of the switching frequency, the energy is now spread over a bandwidth that increases with frequency. Above a few megahertz, the wideband spectrum looks like white noise for EMI purposes (Figure 3).

3.2W, High-Efficiency, Low-EMI, Filterless, Class D Audio Amplifier

MAX9759

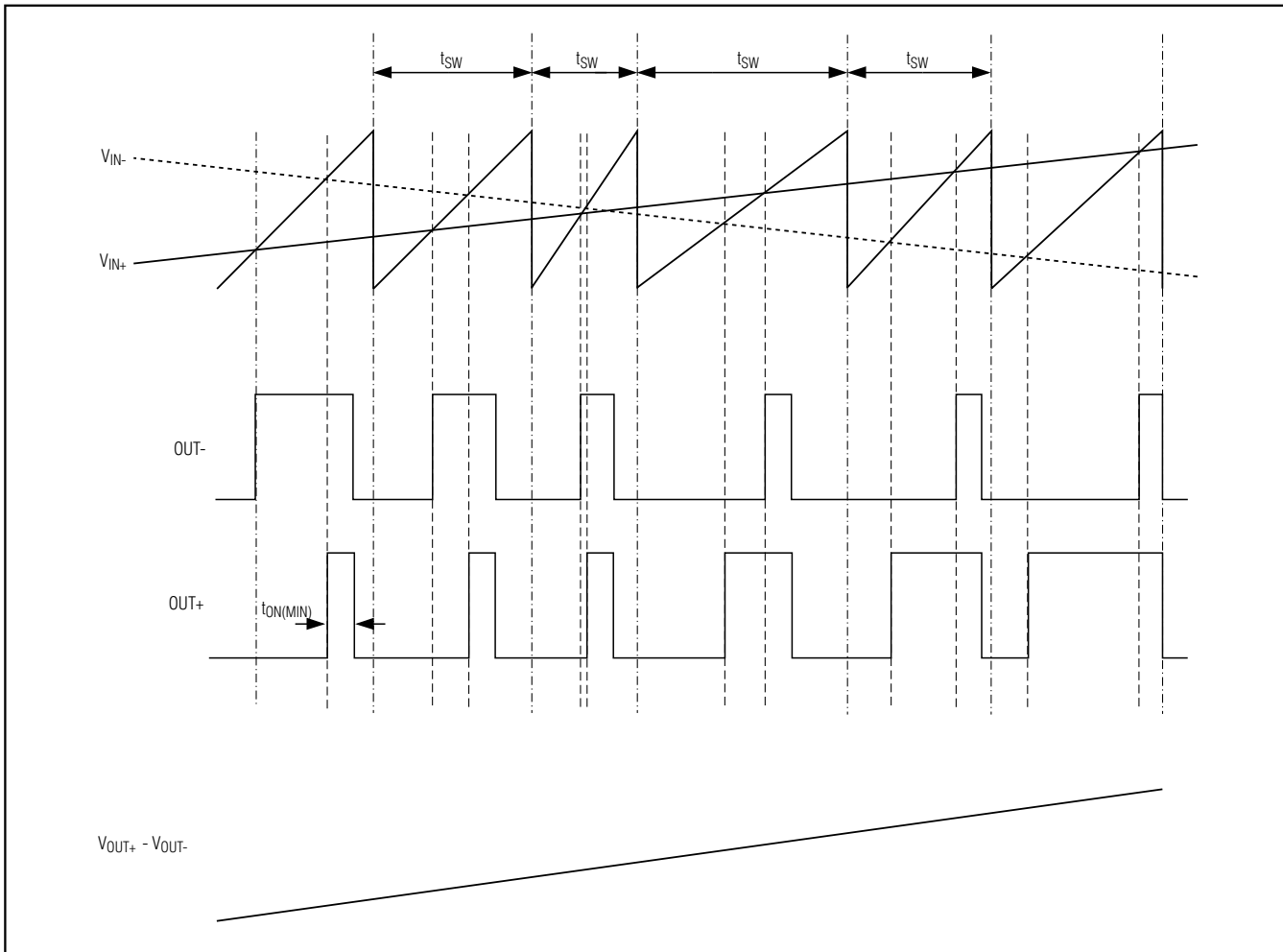

Figure 2. MAX9759 Outputs with an Input Signal Applied (SSM Mode)

External Synchronization

The SYNC function allows the MAX9759 to allocate spectral components of the switching harmonics to insensitive frequency bands and facilitates synchronization to a system clock (allowing for a fully synchronous system). Applying an external TTL clock of 1000kHz to 1600kHz to SYNC synchronizes the switching frequency of the MAX9759. The period of the SYNC clock can be randomized, enabling the MAX9759 to be synchronized to another MAX9759 operating in SSM mode.

Cascading Amplifiers

The SYNC_OUT function of the MAX9759 allows for multiple Maxim class D amplifiers to be cascaded and frequency locked. Synchronizing multiple class D amplifiers ensures that no beat frequencies within the

audio spectrum occur on the power-supply rails. Any intermodulation distortion due to the interference of several modulation frequencies is minimized as a result. Leave the SYNC_OUT pin of the MAX9759 floating if the SYNC_OUT function is not applicable.

Filterless Modulation/Common-Mode Idle

The MAX9759 uses Maxim's unique, patented modulation scheme that eliminates the LC filter required by traditional class D amplifiers, improving efficiency, reducing component count, and conserving board space and system cost. Conventional class D amplifiers output a 50% duty-cycle square wave when no signal is present. With no filter, the square wave appears across the load as a DC voltage, resulting in finite load current, increasing power consumption. When no signal is pre-

3.2W, High Efficiency, Low-EMI, Filterless, Class D Audio Amplifier

MAX9759

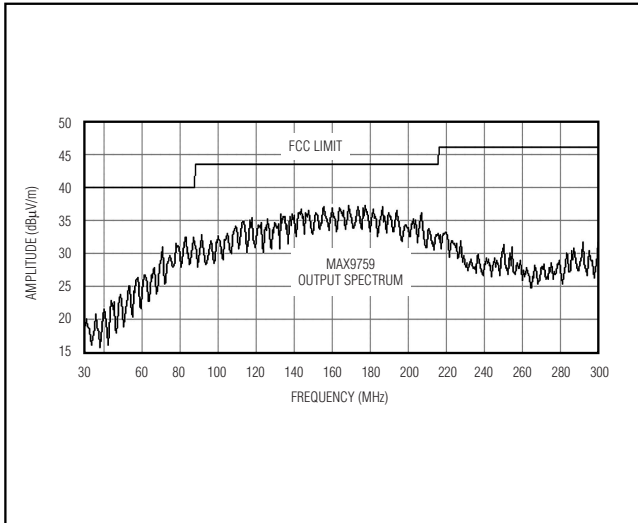

Figure 3. MAX9759 EMI Spectrum

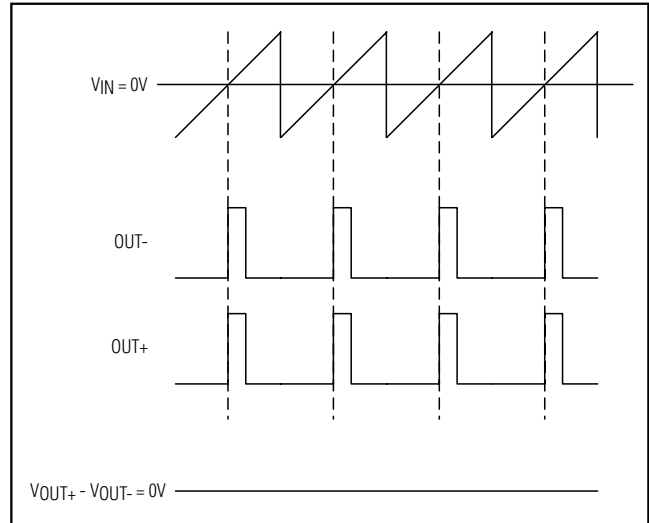

Figure 4. MAX9759 Outputs with No Input Signal

sent at the input of the MAX9759, the outputs switch as shown in Figure 4. Because the MAX9759 drives the speaker differentially, the two outputs cancel each other, resulting in no net Idle Mode™ voltage across the speaker and minimal power consumption.

Efficiency

Efficiency of a class D amplifier is mostly associated with the region of operation of the output stage transistors. In a class D amplifier, the output transistors act as current-steering switches and consume negligible additional power. Any power loss associated with the class D output stage is mostly due to the $I \times R$ loss of the MOSFET on-resistance and quiescent current overhead.

The theoretical best efficiency of a linear amplifier is 78%; however, that efficiency is only exhibited at peak output powers. Under normal operating levels (i.e., typical music reproduction levels), efficiency of a linear amplifier can fall below 30%. The MAX9759 class D amplifier still exhibits >90% efficiencies under the same conditions (Figure 5).

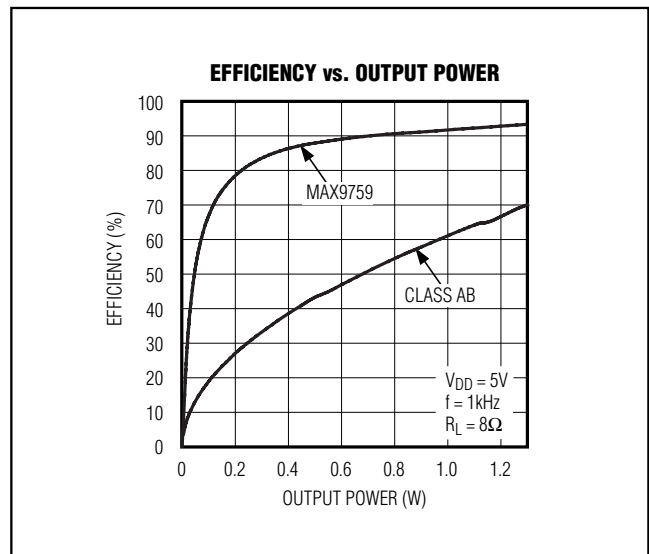

Figure 5. MAX9759 Efficiency vs. Output Power

Gain Selection

The MAX9759 features an internally set, logic-selectable gain. The G1 and G2 logic inputs set the gain of the MAX9759 speaker amplifier (Table 2).

Shutdown

The MAX9759 features a shutdown mode that reduces power consumption and extends battery life. Driving SHDN low places the MAX9759 in a low-power (0.1µA) shutdown mode. Drive SHDN high for normal operation.

Idle Mode is a trademark of Maxim Integrated Products, Inc.

Table 2. Gain Selection

G2	G1	GAIN (dB)
0	0	+24
0	1	+18
1	0	+12
1	1	+6

3.2W, High-Efficiency, Low-EMI, Filterless, Class D Audio Amplifier

MAX9759

Mute

The MAX9759 features a mute function that disables the H-bridge outputs of the switching amplifier. The mute function only affects the power amplifiers of the MAX9759; it does not shut down the device. Driving $\overline{\text{MUTE}}$ low places the MAX9759 in a disabled output mode. Drive $\overline{\text{MUTE}}$ high for normal operation.

Click-and-Pop Suppression

The MAX9759 features comprehensive click-and-pop suppression that eliminates audible transients on startup and shutdown. While in shutdown, the H-bridge is in a high-impedance state. During startup or power-up, the input amplifiers are muted and an internal loop sets the modulator bias voltages to the correct levels, preventing clicks and pops when the H-bridge is subsequently enabled. For 40ms following startup, a soft-start function gradually unmutes the input amplifiers.

For improved click-and-pop performance, sequence the digital inputs of the $\overline{\text{SHDN}}$ and $\overline{\text{MUTE}}$ pins of the MAX9759 during power-up and power-down of the device such that transients are eliminated from each power cycle. Apply power to the MAX9759 with both $\overline{\text{SHDN}}$ and $\overline{\text{MUTE}}$ held low. Release $\overline{\text{SHDN}}$ before $\overline{\text{MUTE}}$ such that minimal transients occur during startup of the device. The mute function allows the MAX9759 to be powered up with the H-bridge outputs of the switching amplifier disabled. For power-down, sequence the power cycle such that the amplifier is muted first and subsequently shut down before power is disconnected from the IC. This power cycle eliminates any audible transients on power-up and power-down of the MAX9759.

Applications Information

Filterless Operation

Traditional class D amplifiers require an output filter to recover the audio signal from the amplifier's output. The filters add cost, increase the solution size of the amplifier, and can decrease efficiency. The traditional PWM scheme uses large differential output swings ($2 \times V_{\text{DD}}$ peak-to-peak) and causes large ripple currents. Any parasitic resistance in the filter components results in a loss of power, lowering the efficiency.

The MAX9759 does not require an output filter for the short speaker cable. The device relies on the inherent inductance of the speaker coil and the natural filtering of both the speaker and the human ear to recover the audio component of the square-wave output. Eliminating the output filter results in a smaller, less costly, more efficient solution.

Because the frequency of the MAX9759 output is well beyond the bandwidth of most speakers, voice coil movement due to the switching frequency is very small.

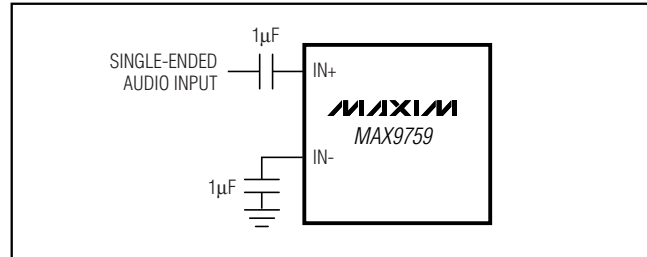

Figure 6. Single-Ended Input

Although this movement is small, a speaker not designed to handle the additional power can be damaged. For optimum results, use a speaker with a series inductance $> 10\mu\text{H}$ to $100\mu\text{H}$ range.

Power-Conversion Efficiency

Unlike a class AB amplifier, the output offset voltage of a class D amplifier does not noticeably increase quiescent current draw when a load is applied. This is due to the power conversion of the class D amplifier. For example, an 8mV DC offset across an 8Ω load results in 1mA extra current consumption in a class AB device. In the class D case, an 8mV offset into an 8Ω load equates to an additional power drain of $8\mu\text{W}$. Due to the high efficiency of the class D amplifier, this represents an additional quiescent current draw of $8\mu\text{W}/(V_{\text{DD}}/100\eta)$, which is on the order of a few microamps.

Input Amplifier

Differential Input

The MAX9759 features a differential input structure, making it compatible with many CODECs, and offers improved noise immunity over a single-ended input amplifier. High-frequency signals can be picked up by the amplifier's input traces and can appear at the amplifier's inputs as common-mode noise. A differential input amplifier amplifies the difference of the two inputs; any signal common to both inputs is cancelled.

Single-Ended Input

The MAX9759 can be configured as a single-ended input amplifier by capacitively coupling one input to GND while simultaneously driving the other input (Figure 6).

DC-Coupled Input

The input amplifier can accept DC-coupled inputs that are biased within the amplifier's common-mode range (see the *Typical Operating Characteristics*). DC coupling eliminates the input-coupling capacitors, reducing component count to potentially one external component (see the *System Diagram*). However, the low-frequency rejection of the capacitors is lost, allowing low-frequency signals to feedthrough to the load.

3.2W, High-Efficiency, Low-EMI, Filterless, Class D Audio Amplifier

MAX9759

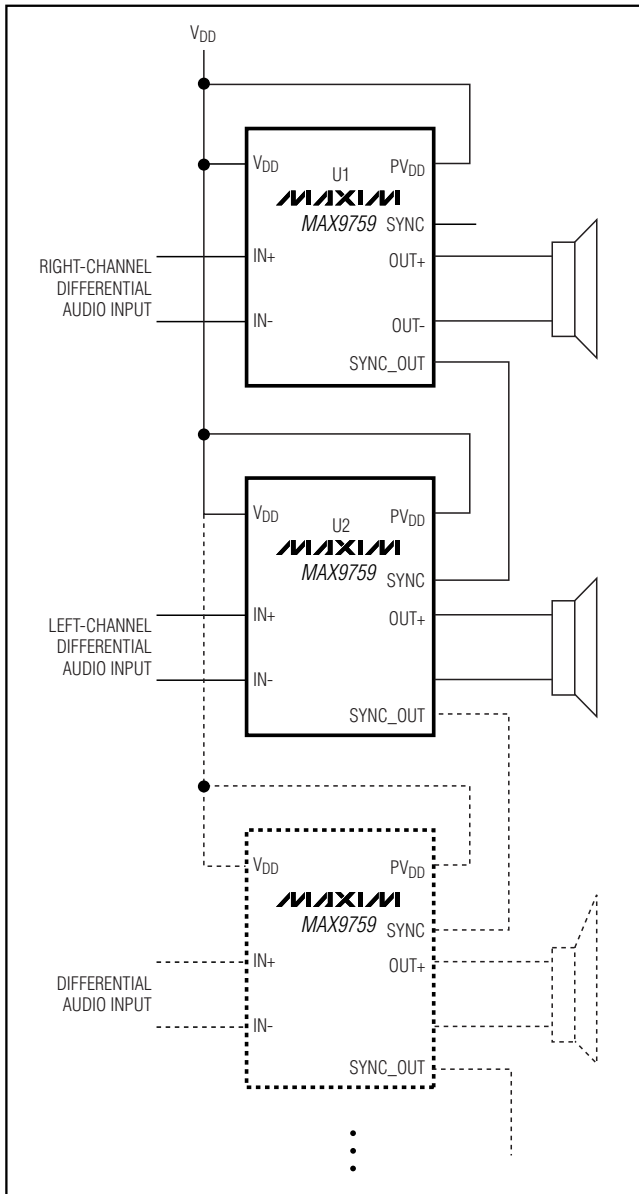

Figure 7. Master-Slave Configuration

Component Selection

Input Filter

An input capacitor, C_{IN} , in conjunction with the input impedance of the MAX9759 forms a highpass filter that removes the DC bias from an incoming signal. The AC-coupling capacitor allows the amplifier to bias the signal to an optimum DC level. Assuming zero source impedance, the -3dB point of the highpass filter is given by:

$$f_{-3dB} = 1/(2\pi R_{IN}C_{IN})$$

Choose C_{IN} such that f_{-3dB} is well below the lowest frequency of interest. Setting f_{-3dB} too high affects the low-frequency response of the amplifier. Use capacitors whose dielectrics have low-voltage coefficients, such as tantalum or aluminum electrolytic. Capacitors with high-voltage coefficients, such as ceramics, may result in increased distortion at low frequencies.

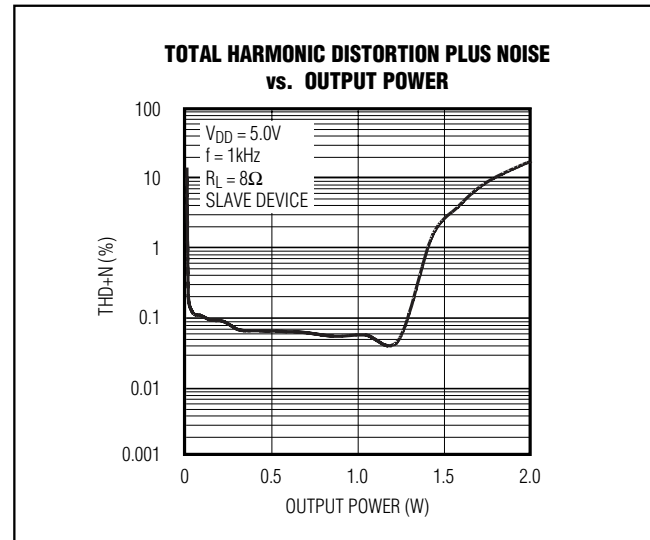

Figure 8. Total Harmonic Distortion Plus Noise vs. Output Voltage

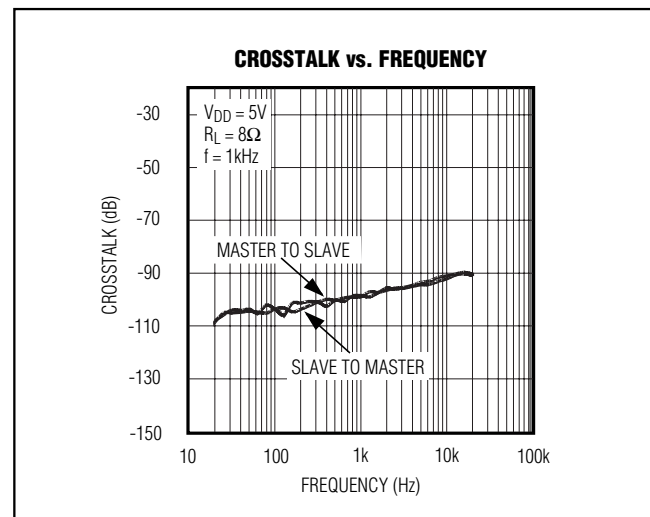

Figure 9. Crosstalk vs. Frequency

3.2W, High-Efficiency, Low-EMI, Filterless, Class D Audio Amplifier

MAX9759

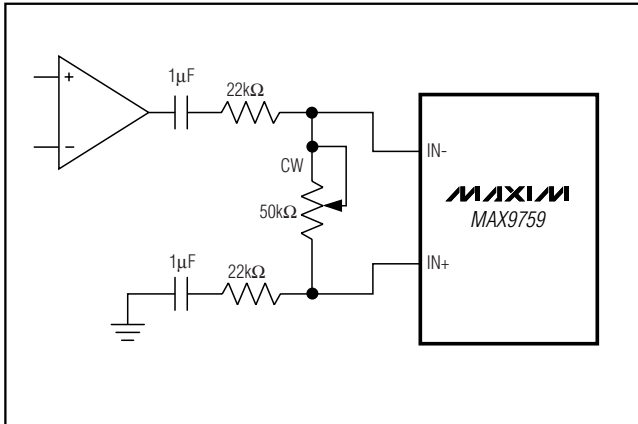

Figure 10. Single-Ended Drive of MAX9759 Plus Volume Control

Output Filter

The MAX9759 does not require an output filter for the short speaker cable. The device passes FCC emissions standards with 7.6cm of unshielded speaker cables. However, output filtering can be used if a design is failing radiated emissions due to board layout, cable length, or the circuit's close proximity to EMI-sensitive devices. Use an LC filter when radiated emissions are a concern, or when long leads are used to connect the amplifier to the speaker.

Supply Bypassing, Layout, and Grounding

Proper power-supply bypassing ensures low-distortion operation. For optimum performance, bypass V_{DD} to GND and PV_{DD} to PGND with separate 0.1µF capacitors as close to each pin as possible. A low-impedance, high-current, power-supply connection to PV_{DD} is assumed. Additional bulk capacitance should be added as required depending on the application and power-supply characteristics. GND and PGND should be star-connected to system ground.

Use wide, low-resistance output traces. As load impedance decreases, the current drawn from the device outputs increase. At higher current, the resistance of the output traces decrease the power delivered to the load. Wide output, supply, and GND traces also improve the power dissipation of the device.

The MAX9759 thin QFN package features an exposed thermal pad on its underside. This pad lowers the package's thermal resistance by providing a direct heat conduction path. Due to the high efficiency of the MAX9759's Class D Amplifier, additional heatsinking is not required. If additional heatsinking is required, connect the exposed paddle to GND.

Stereo Configuration

Two MAX9759s can be configured as a stereo amplifier (Figure 7). Device U1 is the master amplifier; its oscillator output, SYNC_OUT, drives the SYNC input of the slave device (U2), synchronizing the switching frequencies of the two devices. Synchronizing two MAX9759s ensures that no beat frequencies within the audio spectrum occur on the power-supply rails. This stereo configuration works when the master device is in either FFM or SSM mode. There is excellent THD+N performance and minimal crosstalk between devices due to the SYNC and SYNC_OUT connection (Figures 8, 9).

Multiple MAX9759s can be cascaded and frequency locked in a similar fashion (Figure 7). Repeat the stereo configuration outlined in Figure 7 for multiple cascading amplifier applications.

Volume Control

If volume control is required, connect a potentiometer between the differential inputs of the MAX9759, as seen in Figure 10. In this configuration, each input "sees" identical RC paths when the device is powered up. The variable resistive element appears between the two inputs, meaning the setting affects both inputs the same way. This configuration significantly improves transient performance on power-up or release from SHDN.

MAX9759

3.2W, High-Efficiency, Low-EMI, Filterless, Class D Audio Amplifier

System Diagram

MAX9759

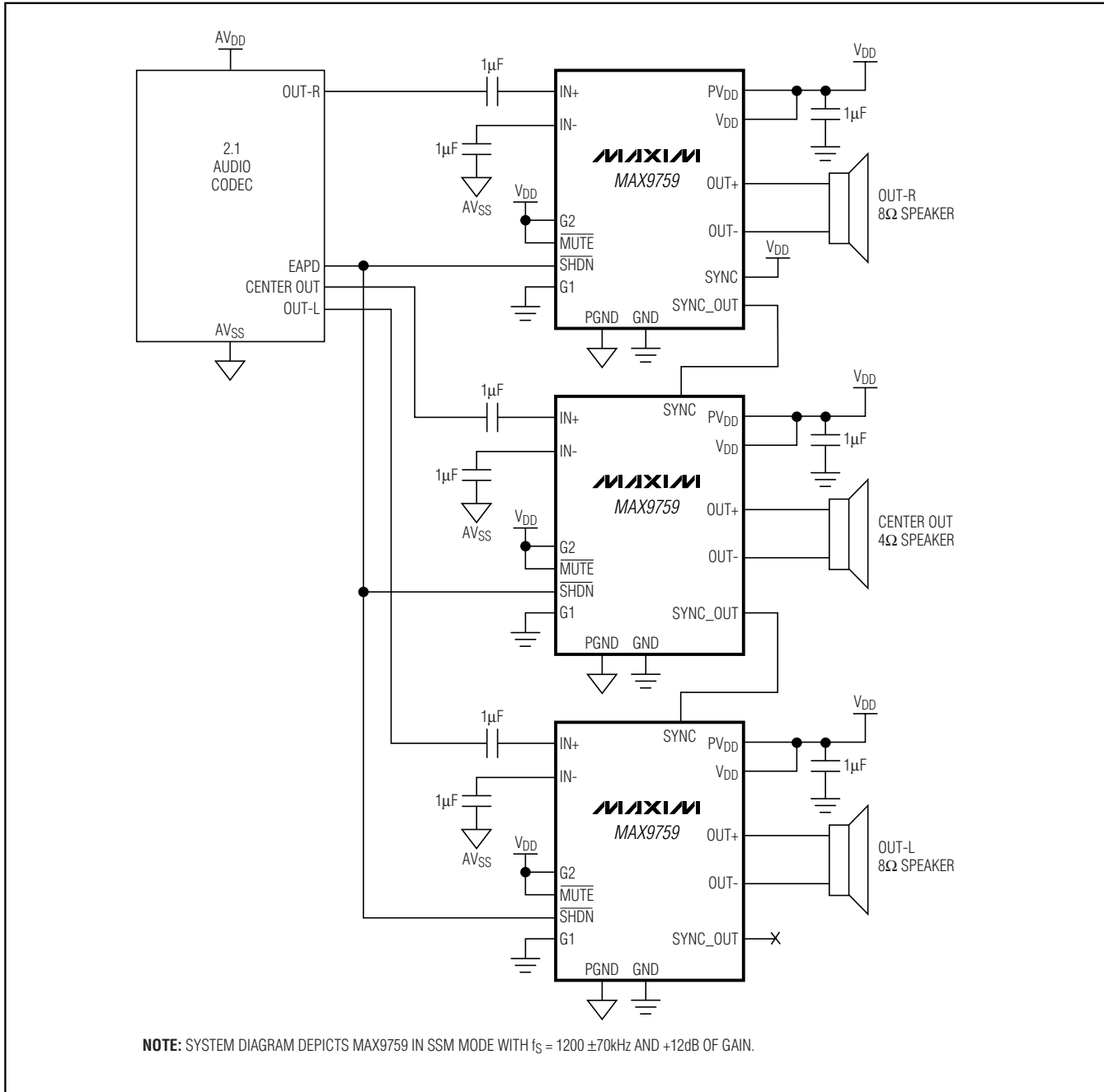

3.2W, High-Efficiency, Low-EMI, Filterless, Class D Audio Amplifier

MAX9759

Pin Configurations

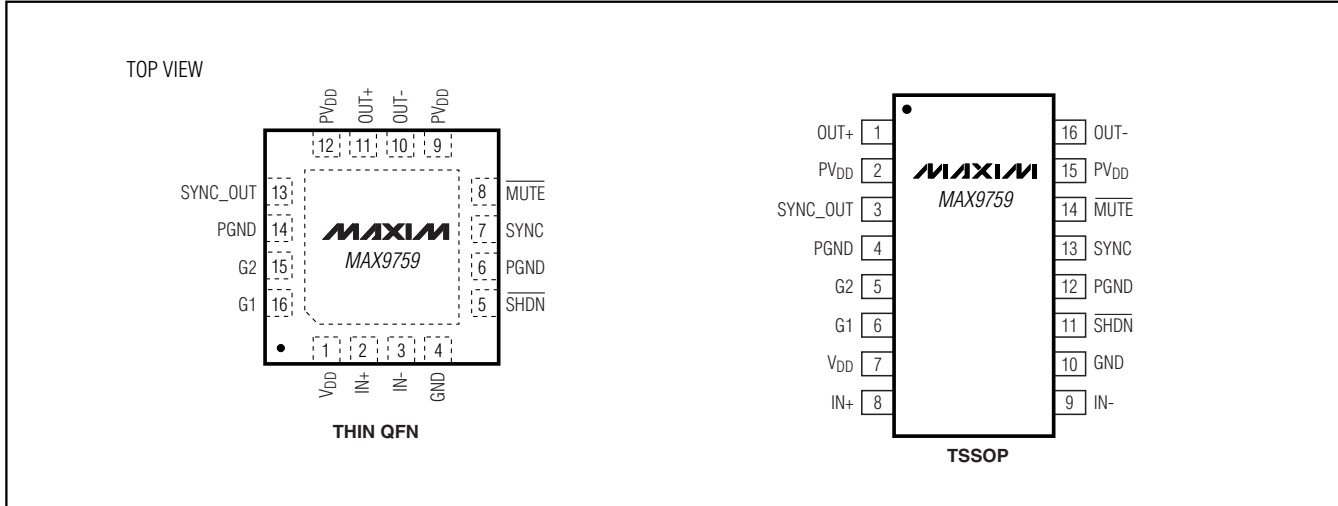

Chip Information

TRANSISTOR COUNT: 4219

PROCESS: BiCMOS

3.2W, High-Efficiency, Low-EMI, Filterless, Class D Audio Amplifier

Package Information

(The package drawing(s) in this data sheet may not reflect the most current specifications. For the latest package outline information, go to www.maxim-ic.com/packages.)

MAX9759

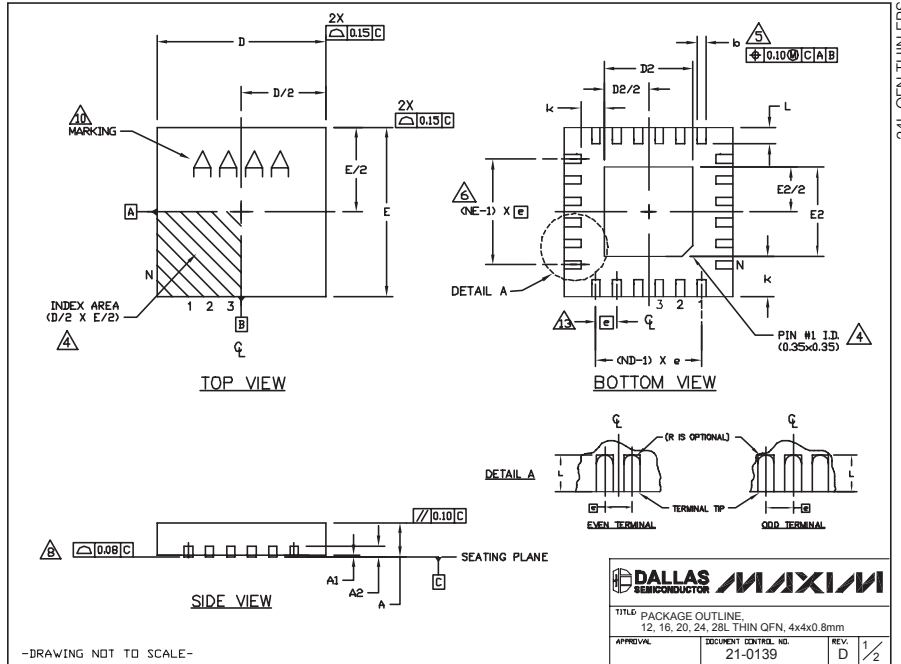

-DRAWING NOT TO SCALE-

COMMON DIMENSIONS															
PKG	12L 4x4			16L 4x4			20L 4x4			24L 4x4			28L 4x4		
REF.	MIN.	NDM.	MAX.	MIN.	NDM.	MAX.	MIN.	NDM.	MAX.	MIN.	NDM.	MAX.	MIN.	NDM.	MAX.
A	0.70	0.75	0.90	0.70	0.75	0.90	0.70	0.75	0.90	0.70	0.75	0.90	0.70	0.75	0.90
A1	0.0	0.02	0.05	0.0	0.02	0.05	0.0	0.02	0.05	0.0	0.02	0.05	0.0	0.02	0.05
A2	0.20	REF.		0.20	REF.		0.20	REF.		0.20	REF.		0.20	REF.	
b	0.25	0.30	0.35	0.25	0.30	0.35	0.20	0.25	0.30	0.18	0.23	0.30	0.15	0.20	0.25
D	3.90	4.00	4.10	3.90	4.00	4.10	3.90	4.00	4.10	3.90	4.00	4.10	3.90	4.00	4.10
E	3.90	4.00	4.10	3.90	4.00	4.10	3.90	4.00	4.10	3.90	4.00	4.10	3.90	4.00	4.10
e	0.80	BSC.		0.65	BSC.		0.50	BSC.		0.50	BSC.		0.40	BSC.	
k	0.25	-	-	0.25	-	-	0.25	-	-	0.25	-	-	0.25	-	-
L	0.45	0.55	0.65	0.45	0.55	0.65	0.45	0.55	0.65	0.30	0.40	0.50	0.30	0.40	0.50
N	12			16			20			24			28		
ND	3			4			5			6			7		
NE	3			4			5			6			7		
JEDEC Vgr.	VGG8			VGGC			VGGD-1			VGGD-2			VGGE		

EXPOSED PAD VARIATIONS												
PKG CODES	D2			E2			DOWN BONDS ALLOWED					
	MIN.	NDM.	MAX.	MIN.	NDM.	MAX.						
T1244-2	1.95	2.10	2.25	1.95	2.10	2.25	ND					
T1244-3	1.95	2.10	2.25	1.95	2.10	2.25	YES					
T1244-4	1.95	2.10	2.25	1.95	2.10	2.25	ND					
T1644-2	1.95	2.10	2.25	1.95	2.10	2.25	ND					
T1644-3	1.95	2.10	2.25	1.95	2.10	2.25	YES					
T1644-4	1.95	2.10	2.25	1.95	2.10	2.25	ND					
T2044-1	1.95	2.10	2.25	1.95	2.10	2.25	ND					
T2044-2	1.95	2.10	2.25	1.95	2.10	2.25	YES					
T2044-3	1.95	2.10	2.25	1.95	2.10	2.25	ND					
T2444-1	2.45	2.60	2.63	2.45	2.60	2.63	ND					
T2444-2	1.95	2.10	2.25	1.95	2.10	2.25	YES					
T2444-3	2.45	2.60	2.63	2.45	2.60	2.63	YES					
T2444-4	2.45	2.60	2.63	2.45	2.60	2.63	ND					
T2844-1	2.50	2.60	2.70	2.50	2.60	2.70	ND					

NOTES:

- DIMENSIONING & TOLERANCING CONFORM TO ASME Y14.5M-1994.
- ALL DIMENSIONS ARE IN MILLIMETERS. ANGLES ARE IN DEGREES.
- N IS THE TOTAL NUMBER OF TERMINALS.
- THE TERMINAL #1 IDENTIFIER AND TERMINAL NUMBERING CONVENTION SHALL CONFORM TO JEDEC 95-1 SPP-012. DETAILS OF TERMINAL #1 IDENTIFIER ARE OPTIONAL, BUT MUST BE LOCATED WITHIN THE ZONE INDICATED. THE TERMINAL #1 IDENTIFIER MAY BE EITHER A MOLD OR MARKED FEATURE.
- DIMENSION b APPLIES TO METALLIZED TERMINAL AND IS MEASURED BETWEEN 0.25 mm AND 0.30 mm FROM TERMINAL TIP.
- ND AND NE REFER TO THE NUMBER OF TERMINALS ON EACH D AND E SIDE RESPECTIVELY.
- DEPOPULATION IS POSSIBLE IN A SYMMETRICAL FASHION.
- COPLANARITY APPLIES TO THE EXPOSED HEAT SINK SLUG AS WELL AS THE TERMINALS.
- DRAWING CONFORMS TO JEDEC MO220, EXCEPT FOR T2444-1, T2444-3, T2444-4 AND T2844-1.
- MARKING IS FOR PACKAGE ORIENTATION REFERENCE ONLY.
- COPLANARITY SHALL NOT EXCEED 0.08mm
- WARPAGE SHALL NOT EXCEED 0.10mm
- LEAD CENTERLINES TO BE AT TRUE POSITION AS DEFINED BY BASIC DIMENSION "a", ±0.05.

-DRAWING NOT TO SCALE-

COMMON DIMENSIONS															
PKG	12L 4x4			16L 4x4			20L 4x4			24L 4x4			28L 4x4		
REF.	MIN.	NDM.	MAX.	MIN.	NDM.	MAX.	MIN.	NDM.	MAX.	MIN.	NDM.	MAX.	MIN.	NDM.	MAX.
A	0.70	0.75	0.90	0.70	0.75	0.90	0.70	0.75	0.90	0.70	0.75	0.90	0.70	0.75	0.90
A1	0.0	0.02	0.05	0.0	0.02	0.05	0.0	0.02	0.05	0.0	0.02	0.05	0.0	0.02	0.05
A2	0.20	REF.		0.20	REF.		0.20	REF.		0.20	REF.		0.20	REF.	
b	0.25	0.30	0.35	0.25	0.30	0.35	0.20	0.25	0.30	0.18	0.23	0.30	0.15	0.20	0.25
D	3.90	4.00	4.10	3.90	4.00	4.10	3.90	4.00	4.10	3.90	4.00	4.10	3.90	4.00	4.10
E	3.90	4.00	4.10	3.90	4.00	4.10	3.90	4.00	4.10	3.90	4.00	4.10	3.90	4.00	4.10
e	0.80	BSC.		0.65	BSC.		0.50	BSC.		0.50	BSC.		0.40	BSC.	
k	0.25	-	-	0.25	-	-	0.25	-	-	0.25	-	-	0.25	-	-
L	0.45	0.55	0.65	0.45	0.55	0.65	0.45	0.55	0.65	0.30	0.40	0.50	0.30	0.40	0.50
N	12			16			20			24			28		
ND	3			4			5			6			7		
NE	3			4			5			6			7		
JEDEC Vgr.	VGG8			VGGC			VGGD-1			VGGD-2			VGGE		

EXPOSED PAD VARIATIONS												
PKG CODES	D2			E2			DOWN BONDS ALLOWED					
	MIN.	NDM.	MAX.	MIN.	NDM.	MAX.						
T1244-2	1.95	2.10	2.25	1.95	2.10	2.25	ND					
T1244-3	1.95	2.10	2.25	1.95	2.10	2.25	YES					
T1244-4	1.95	2.10	2.25	1.95	2.10	2.25	ND					
T1644-2	1.95	2.10	2.25	1.95	2.10	2.25	ND					
T1644-3	1.95	2.10	2.25	1.95	2.10	2.25	YES					
T1644-4	1.95	2.10	2.25	1.95	2.10	2.25	ND					
T2044-1	1.95	2.10	2.25	1.95	2.10	2.25	ND					
T2044-2	1.95	2.10	2.25	1.95	2.10	2.25	YES					
T2044-3	1.95	2.10	2.25	1.95	2.10	2.25	ND					
T2444-1	2.45	2.60	2.63	2.45	2.60	2.63	ND					
T2444-2	1.95	2.10	2.25	1.95	2.10	2.25	YES					
T2444-3	2.45	2.60	2.63	2.45	2.60	2.63	YES					
T2444-4	2.45	2.60	2.63	2.45	2.60	2.63	ND					
T2844-1	2.50	2.60	2.70	2.50	2.60	2.70	ND					

NOTES:

- DIMENSIONING & TOLERANCING CONFORM TO ASME Y14.5M-1994.
- ALL DIMENSIONS ARE IN MILLIMETERS. ANGLES ARE IN DEGREES.
- N IS THE TOTAL NUMBER OF TERMINALS.
- THE TERMINAL #1 IDENTIFIER AND TERMINAL NUMBERING CONVENTION SHALL CONFORM TO JEDEC 95-1 SPP-012. DETAILS OF TERMINAL #1 IDENTIFIER ARE OPTIONAL, BUT MUST BE LOCATED WITHIN THE ZONE INDICATED. THE TERMINAL #1 IDENTIFIER MAY BE EITHER A MOLD OR MARKED FEATURE.
- DIMENSION b APPLIES TO METALLIZED TERMINAL AND IS MEASURED BETWEEN 0.25 mm AND 0.30 mm FROM TERMINAL TIP.
- ND AND NE REFER TO THE NUMBER OF TERMINALS ON EACH D AND E SIDE RESPECTIVELY.
- DEPOPULATION IS POSSIBLE IN A SYMMETRICAL FASHION.
- COPLANARITY APPLIES TO THE EXPOSED HEAT SINK SLUG AS WELL AS THE TERMINALS.
- DRAWING CONFORMS TO JEDEC MO220, EXCEPT FOR T2444-1, T2444-3, T2444-4 AND T2844-1.
- MARKING IS FOR PACKAGE ORIENTATION REFERENCE ONLY.
- COPLANARITY SHALL NOT EXCEED 0.08mm
- WARPAGE SHALL NOT EXCEED 0.10mm
- LEAD CENTERLINES TO BE AT TRUE POSITION AS DEFINED BY BASIC DIMENSION "a", ±0.05.

-DRAWING NOT TO SCALE-

3.2W, High-Efficiency, Low-EMI, Filterless, Class D Audio Amplifier

MAX9759

MAX9759

Package Information (continued)

(The package drawing(s) in this data sheet may not reflect the most current specifications. For the latest package outline information, go to www.maxim-ic.com/packages.)

Symbol	COMMON DIMENSIONS			
	MILLIMETERS		INCHES	
	MIN.	MAX.	MIN.	MAX.
A	—	1.10	—	.043
A ₁	0.05	0.15	.002	.006
A ₂	0.85	0.95	.033	.037
b	0.19	0.30	.007	.012
b ₁	0.19	0.25	.007	.010
c	0.09	0.20	.004	.008
c ₁	0.09	0.14	.004	.006
D	SEE VARIATIONS		SEE VARIATIONS	
E	4.30	4.50	.169	.177
e	0.65 BSC		.026 BSC	
H	6.25	6.55	.246	.258
L	0.50	0.70	.020	.028
N	SEE VARIATIONS		SEE VARIATIONS	
α	0°	8°	0°	8°

JEDEC	N	VARIATIONS			
		MILLIMETERS		INCHES	
		MIN.	MAX.	MIN.	MAX.
AB-1	14 D	4.90	5.10	.193	.201
AB	16 D	4.90	5.10	.193	.201
AC	20 D	6.40	6.60	.252	.260
AD	24 D	7.70	7.90	.303	.311
AE	28 D	9.60	9.80	.378	.386

NOTES:

- DIMENSIONS D AND E DO NOT INCLUDE FLASH
- MOLD FLASH OR PROTRUSIONS NOT TO EXCEED 0.15mm PER SIDE
- CONTROLLING DIMENSION: MILLIMETER
- MEETS JEDEC OUTLINE MD-153. SEE JEDEC VARIATIONS TABLE
- "N" REFERS TO NUMBER OF LEADS
- THE LEAD TIPS MUST LIE WITHIN A SPECIFIED ZONE. THIS TOLERANCE ZONE IS DEFINED BY TWO PARALLEL PLANES. ONE PLANE IS THE SEATING PLANE, DATUM [-C-]; THE OTHER PLANE IS AT THE SPECIFIED DISTANCE FROM [-C-] IN THE DIRECTION INDICATED

-DRAWING NOT TO SCALE-

DALLAS SEMICONDUCTOR **MAXIM**

TITLE: PACKAGE OUTLINE, TSSOP 4.40mm BODY

APPROVAL	DOCUMENT CONTROL NO. 21-0066	REV. G	1/1
----------	---------------------------------	-----------	-----

TSSOP4.40mm:EPS

Maxim cannot assume responsibility for use of any circuitry other than circuitry entirely embodied in a Maxim product. No circuit patent licenses are implied. Maxim reserves the right to change the circuitry and specifications without notice at any time.

20 **Maxim Integrated Products, 120 San Gabriel Drive, Sunnyvale, CA 94086 408-737-7600**