

10W Stereo/15W Mono, Filterless, Spread-Spectrum, Class D Amplifiers

General Description

The MAX9703/MAX9704 mono/stereo Class D audio power amplifiers provide Class AB amplifier performance with Class D efficiency, conserving board space and eliminating the need for a bulky heatsink. Using a Class D architecture, these devices deliver up to 15W while offering up to 78% efficiency. Proprietary and patent-protected modulation and switching schemes render the traditional Class D output filter unnecessary.

The MAX9703/MAX9704 offer two modulation schemes: a fixed-frequency mode (FFM), and a spread-spectrum mode (SSM) that reduces EMI-radiated emissions due to the modulation frequency. The device utilizes a fully differential architecture, a full bridged output, and comprehensive click-and-pop suppression.

The MAX9703/MAX9704 feature high 80dB PSRR, low 0.07% THD+N, and SNR in excess of 95dB. Short-circuit and thermal-overload protection prevent the devices from being damaged during a fault condition. The MAX9703 is available in a 32-pin TQFN (5mm x 5mm x 0.8mm) package. The MAX9704 is available in a 32-pin TQFN (7mm x 7mm x 0.8mm) package. Both devices are specified over the extended -40°C to +85°C temperature range.

Applications

LCD TVs	Hands-Free Car
LCD Monitors	Phone Adaptors
Desktop PCs	Automotive
LCD Projectors	

Features

- ◆ Filterless Class D Amplifier
- ◆ Unique Spread-Spectrum Mode Offers 5dB Emissions Improvement Over Conventional Methods
- ◆ Up to 78% Efficient ($R_L = 8\Omega$)
- ◆ Up to 88% Efficient ($R_L = 16\Omega$)
- ◆ 15W Continuous Output Power into 8Ω (MAX9703)
- ◆ 2x10W Continuous Output Power into 8Ω (MAX9704)
- ◆ Low 0.07% THD+N
- ◆ High PSRR (80dB at 1kHz)
- ◆ 10V to 25V Single-Supply Operation
- ◆ Differential Inputs Minimize Common-Mode Noise
- ◆ Pin-Selectable Gain Reduces Component Count
- ◆ Industry-Leading Click-and-Pop Suppression
- ◆ Low Quiescent Current (24mA)
- ◆ Low-Power Shutdown Mode (0.2 μ A)
- ◆ Short-Circuit and Thermal-Overload Protection
- ◆ Available in Thermally Efficient, Space-Saving Packages

32-Pin TQFN (5mm x 5mm x 0.8mm)—MAX9703
32-Pin TQFN (7mm x 7mm x 0.8mm)—MAX9704

Ordering Information

PART	TEMP RANGE	PIN-PACKAGE	AMP
MAX9703ETJ+	-40°C to +85°C	32 TQFN-EP*	Mono
MAX9704ETJ+	-40°C to +85°C	32 TQFN-EP*	Stereo

*EP = Exposed paddle.

+Denotes lead-free package.

Block Diagrams

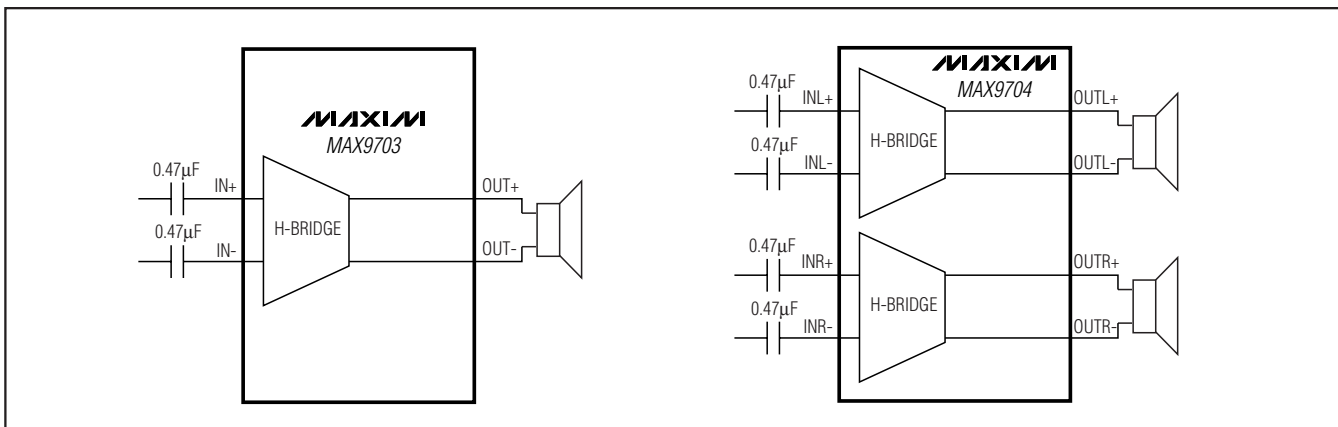

Pin Configurations appear at end of data sheet.

For pricing, delivery, and ordering information, please contact Maxim/Dallas Direct! at

888-629-4642, or visit Maxim's website at www.maxim-ic.com.

10W Stereo/15W Mono, Filterless, Spread-Spectrum, Class D Amplifiers

MAX9703/MAX9704

ABSOLUTE MAXIMUM RATINGS

(All voltages referenced to GND.)

V _{DD} to PGND, AGND	30V
OUTR ₋ , OUTL ₋ , C1N	-0.3V to (V _{DD} + 0.3V)
C1P	(V _{DD} - 0.3V) to (CHOLD + 0.3V)
CHOLD	(V _{DD} - 0.3V) to +40V
All Other Pins to GND	-0.3V to +12V
Duration of OUTR ₋ /OUTL ₋ Short Circuit to GND, V _{DD}	10s
Continuous Input Current (V _{DD} , PGND)	1.6A
Continuous Input Current	0.8A
Continuous Input Current (all other pins)	±20mA

Continuous Power Dissipation (T_A = +70°C)

Single-Layer Board:

MAX9703 32-Pin TQFN (derate 21.3mW/°C above +70°C)	1702.1mW
MAX9704 32-Pin TQFN (derate 27mW/°C above +70°C)	2162.2mW

Multilayer Board:

MAX9703 32-Pin TQFN (derate 34.5mW/°C above +70°C)	2758.6mW
MAX9704 32-Pin TQFN (derate 37mW/°C above +70°C)	2963.0mW

Junction Temperature

Operating Temperature Range

Storage Temperature Range

Lead Temperature (soldering, 10s)

Stresses beyond those listed under "Absolute Maximum Ratings" may cause permanent damage to the device. These are stress ratings only, and functional operation of the device at these or any other conditions beyond those indicated in the operational sections of the specifications is not implied. Exposure to absolute maximum rating conditions for extended periods may affect device reliability.

ELECTRICAL CHARACTERISTICS

(V_{DD} = 15V, GND = PGND = 0V, $\overline{\text{SHDN}} \geq V_{IH}$, A_V = 16dB, C_{SS} = C_{IN} = 0.47μF, C_{REG} = 0.01μF, C1 = 100nF, C2 = 1μF, FS1 = FS2 = GND (f_S = 660kHz), R_L connected between OUTL+ and OUTL- and OUTR+ and OUTR-, T_A = T_{MIN} to T_{MAX}, unless otherwise noted. Typical values are at T_A = +25°C.) (Notes 1, 2)

PARAMETER	SYMBOL	CONDITIONS	MIN	TYP	MAX	UNITS	
GENERAL							
Supply Voltage Range	V _{DD}	Inferred from PSRR test	10		25	V	
Quiescent Current	I _{DD}	R _L = OPEN	MAX9703	14	22	mA	
			MAX9704	24	34		
Shutdown Current	I _{SHDN}			0.2	1.5	μA	
Turn-On Time	t _{ON}	C _{SS} = 470nF		100		ms	
		C _{SS} = 180nF		50			
Amplifier Output Resistance in Shutdown		$\overline{\text{SHDN}} = \text{GND}$	150	330		kΩ	
Input Impedance	R _{IN}	A _V = 13dB	35	58	80	kΩ	
		A _V = 16dB	30	48	65		
		A _V = 19.1dB	23	39	55		
		A _V = 29.6dB	10	15	22		
Voltage Gain	A _V	G1 = L, G2 = L	29.4	29.6	29.8	dB	
		G1 = L, G2 = H	18.9	19.1	19.3		
		G1 = H, G2 = L	12.8	13	13.2		
		G1 = H, G2 = H	15.9	16	16.3		
Gain Matching		Between channels (MAX9704)		0.5		%	
Output Offset Voltage	V _{OS}			±6	±30	mV	
Common-Mode Rejection Ratio	CMRR	f _{IN} = 1kHz, input referred		60		dB	
Power-Supply Rejection Ratio (Note 3)	PSRR	V _{DD} = 10V to 25V	54	80		dB	
		200mV _{P-P} ripple	f _{RIPPLE} = 1kHz		80		
			f _{RIPPLE} = 20kHz		66		

10W Stereo/15W Mono, Filterless, Spread-Spectrum, Class D Amplifiers

MAX9703/MAX9704

ELECTRICAL CHARACTERISTICS (continued)

($V_{DD} = 15V$, $GND = PGND = 0V$, $\overline{SHDN} \geq V_{IH}$, $A_V = 16dB$, $C_{SS} = C_{IN} = 0.47\mu F$, $C_{REG} = 0.01\mu F$, $C_1 = 100nF$, $C_2 = 1\mu F$, $FS_1 = FS_2 = GND$ ($f_S = 660kHz$), R_L connected between $OUTL+$ and $OUTL-$ and $OUTR+$ and $OUTR-$, $T_A = T_{MIN}$ to T_{MAX} , unless otherwise noted. Typical values are at $T_A = +25^\circ C$.) (Notes 1, 2)

PARAMETER	SYMBOL	CONDITIONS		MIN	TYP	MAX	UNITS
Continuous Output Power (MAX9703)	P_{CONT}	THD+N = 10%, $V_{DD} = 16V$, $f = 1kHz$, $T_A = +25^\circ C$, $t_{CONT} = 15min$ (Note 4)	$R_L = 4\Omega$		10		W
			$R_L = 8\Omega$		15		
			$R_L = 16\Omega$, $V_{DD} = 24V$		18		
Continuous Output Power (MAX9704)	P_{CONT}	THD+N = 10%, $V_{DD} = 16V$, $f = 1kHz$, $T_A = +25^\circ C$, $t_{CONT} = 15min$ (Note 4)	$R_L = 4\Omega$		2x5		W
			$R_L = 8\Omega$		2x10		
			$R_L = 16\Omega$, $V_{DD} = 24V$		2x16		
Total Harmonic Distortion Plus Noise	THD+N	$f_{IN} = 1kHz$, either FFM or SSM, $R_L = 8\Omega$, $P_{OUT} = 4W$			0.07		%
Signal-to-Noise Ratio	SNR	$R_L = 8\Omega$, $P_{OUT} = 10W$, $f = 1kHz$	BW = 22Hz to 22kHz	FFM	94		dB
				SSM	88		
			A-weighted	FFM	97		
				SSM	91		
Crosstalk		Left to right, right to left, 8Ω load, $f_{IN} = 10kHz$			65		dB
Oscillator Frequency	f_{OSC}	$FS_1 = L$, $FS_2 = L$		560	670	800	kHz
		$FS_1 = L$, $FS_2 = H$		940			
		$FS_1 = H$, $FS_2 = L$		470			
		$FS_1 = H$, $FS_2 = H$ (spread-spectrum mode)		670	$\pm 7\%$		
Efficiency	η	$P_{OUT} = 15W$, $f = 1kHz$, $R_L = 8\Omega$			78		%
		$P_{OUT} = 10W$, $f = 1kHz$, $R_L = 16\Omega$			88		
Regulator Output	V_{REG}				6		V
DIGITAL INPUTS (\overline{SHDN}, FS_+, G_+)							
Input Thresholds		V_{IH}		2.5			V
		V_{IL}				0.8	
Input Leakage Current					± 1		μA

Note 1: All devices are 100% production tested at $+25^\circ C$. All temperature limits are guaranteed by design.

Note 2: Testing performed with a resistive load in series with an inductor to simulate an actual speaker load. For $R_L = 8\Omega$, $L = 68\mu H$. For $R_L = 4\Omega$, $L = 33\mu H$.

Note 3: PSRR is specified with the amplifier inputs connected to GND through C_{IN} .

Note 4: The MAX9704 continuous 8Ω and 16Ω power measurements account for thermal limitations of the 32-pin TQFN-EP package. Continuous 4Ω power measurements account for short-circuit protection of the MAX9703/MAX9704 devices.

10W Stereo/15W Mono, Filterless, Spread-Spectrum, Class D Amplifiers

MAX9703/MAX9704

Typical Operating Characteristics

(33μH with 4Ω, 68μH with 8Ω, part in SSM mode, 136μH with 16Ω, measurement BW = 22Hz to 22kHz, unless otherwise noted.)

TOTAL HARMONIC DISTORTION PLUS NOISE vs. FREQUENCY

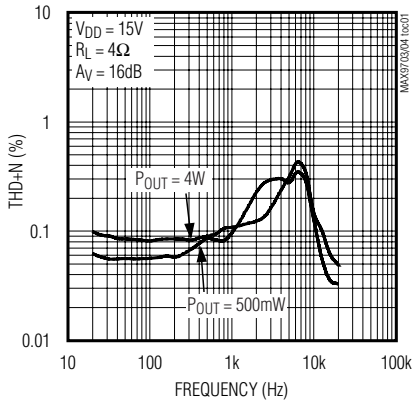

TOTAL HARMONIC DISTORTION PLUS NOISE vs. FREQUENCY

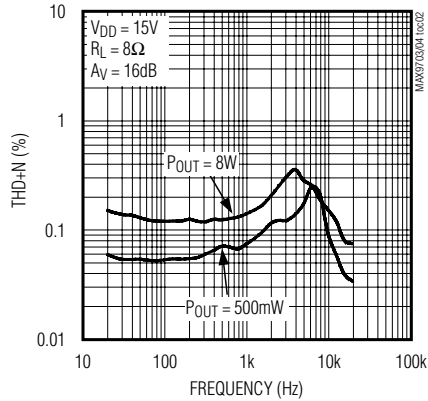

TOTAL HARMONIC DISTORTION PLUS NOISE vs. FREQUENCY

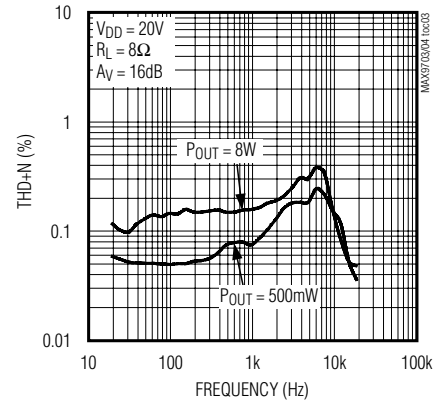

TOTAL HARMONIC DISTORTION PLUS NOISE vs. FREQUENCY

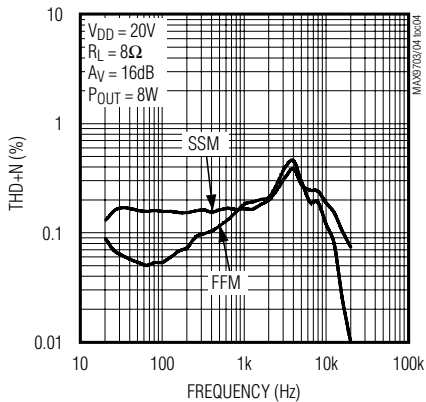

TOTAL HARMONIC DISTORTION PLUS NOISE vs. OUTPUT POWER

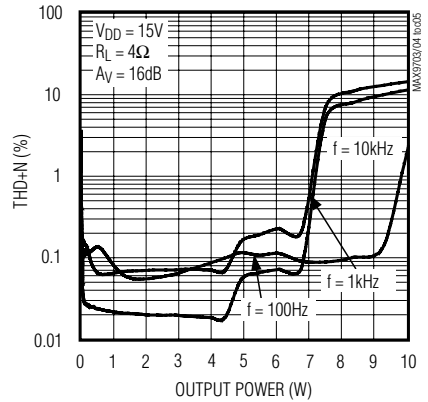

TOTAL HARMONIC DISTORTION PLUS NOISE vs. OUTPUT POWER

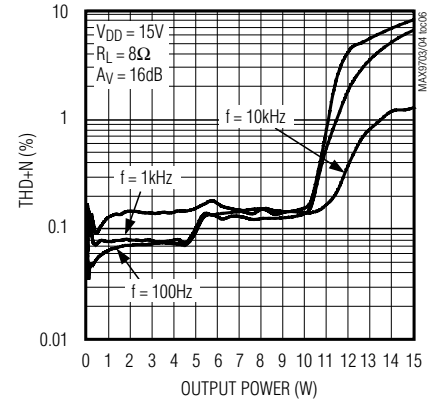

TOTAL HARMONIC DISTORTION PLUS NOISE vs. OUTPUT POWER

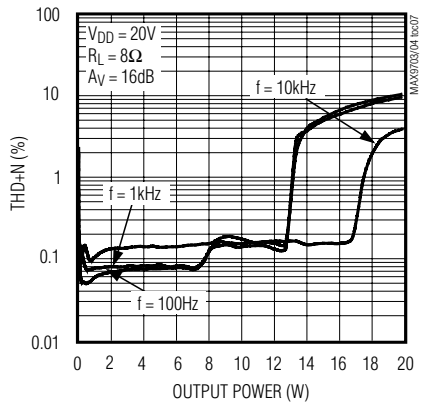

TOTAL HARMONIC DISTORTION PLUS NOISE vs. OUTPUT POWER

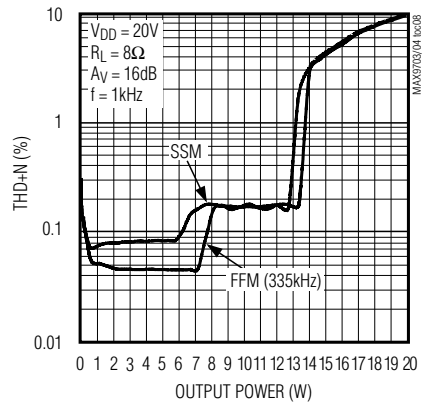

EFFICIENCY vs. OUTPUT POWER

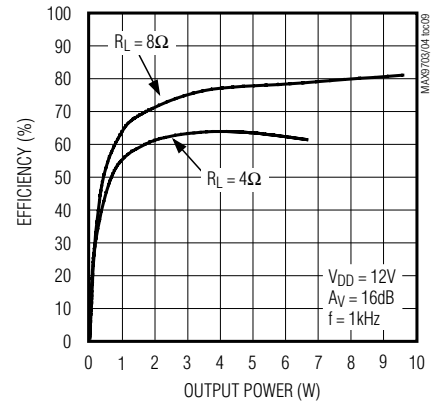

10W Stereo/15W Mono, Filterless, Spread-Spectrum, Class D Amplifiers

Typical Operating Characteristics (continued)

(33μH with 4Ω, 68μH with 8Ω, part in SSM mode, 136μH with 16Ω, measurement BW = 22Hz to 22kHz, unless otherwise noted.)

MAX9703/MAX9704

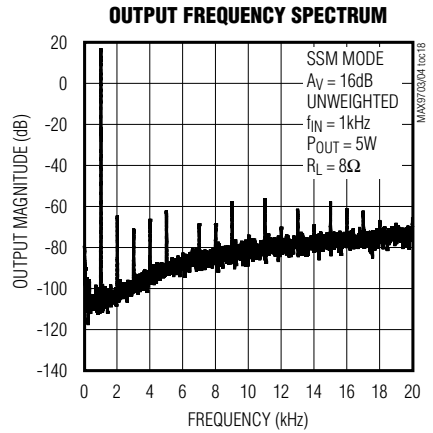
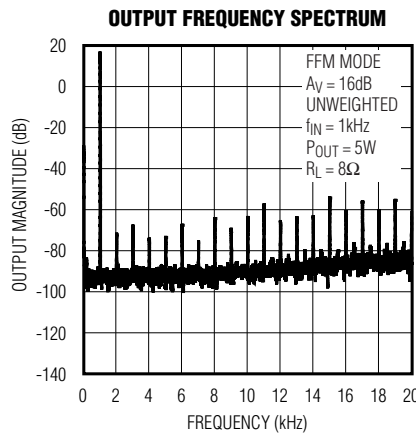
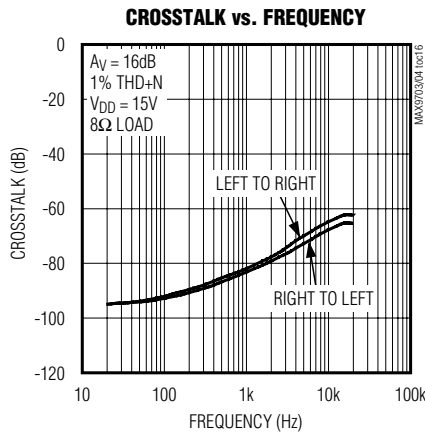
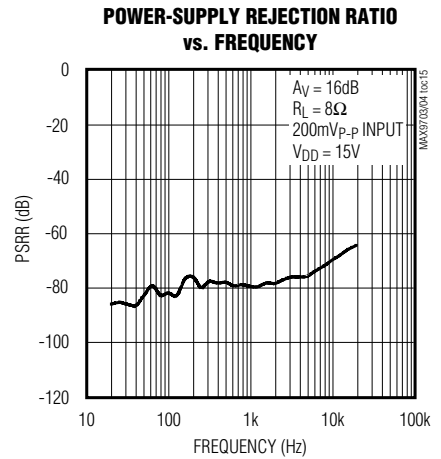
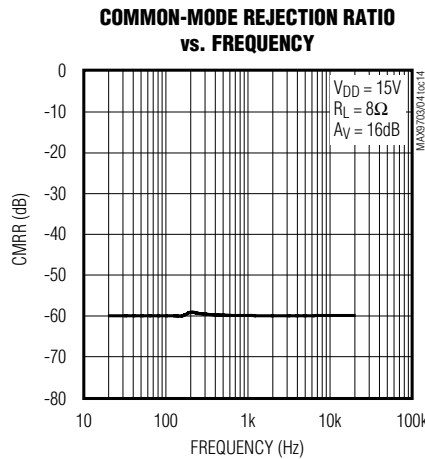
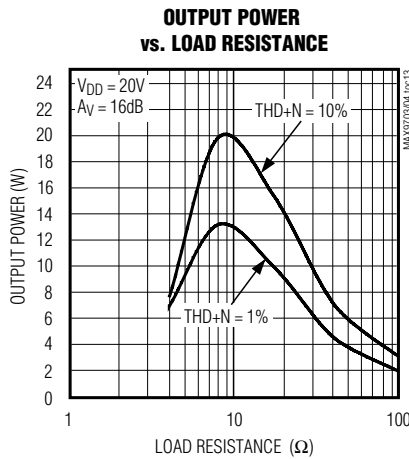
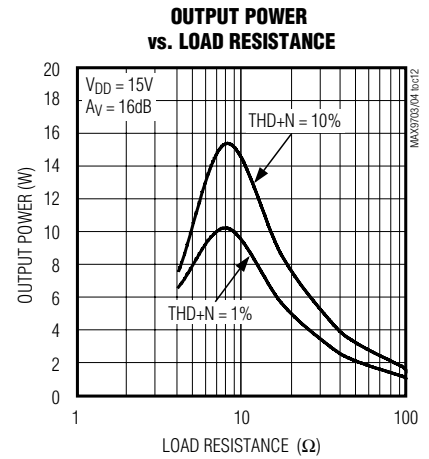
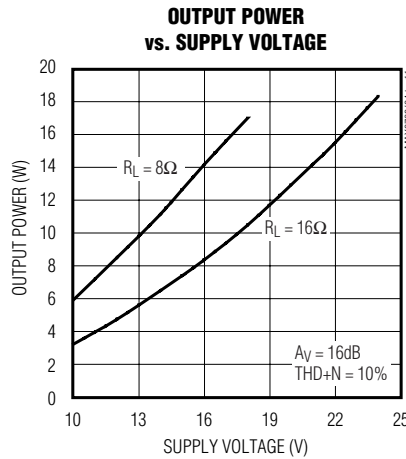
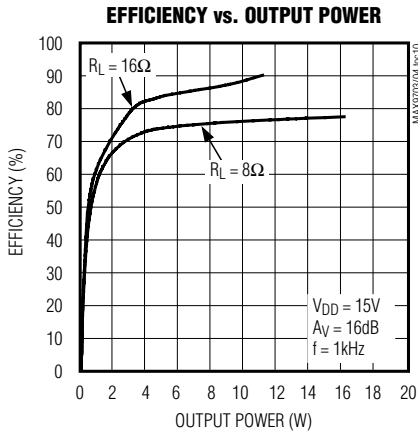

10W Stereo/15W Mono, Filterless, Spread-Spectrum, Class D Amplifiers

MAX9703/MAX9704

Typical Operating Characteristics (continued)

(33 μ H with 4 Ω , 68 μ H with 8 Ω , part in SSM mode, 136 μ H with 16 Ω , measurement BW = 22Hz to 22kHz, unless otherwise noted.)

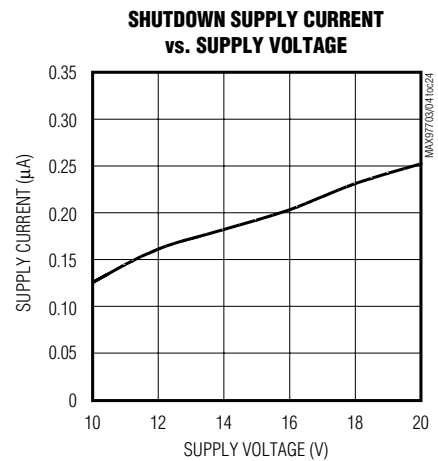
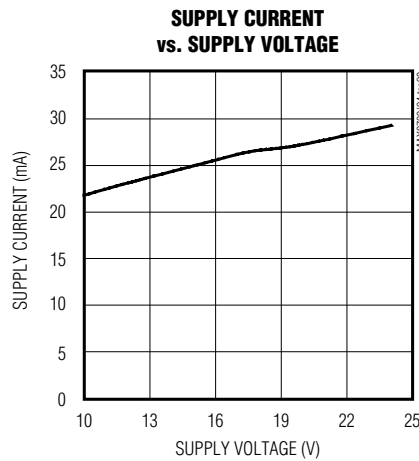
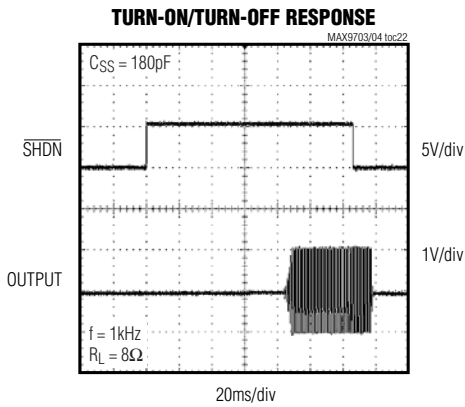
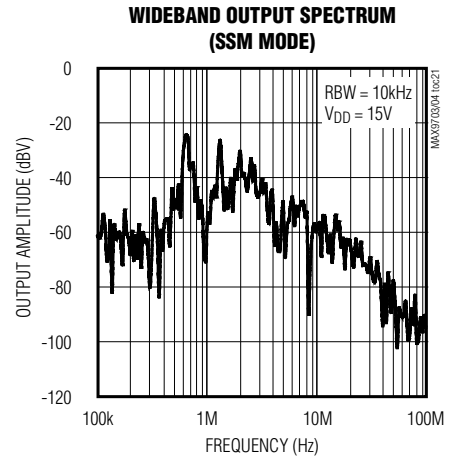
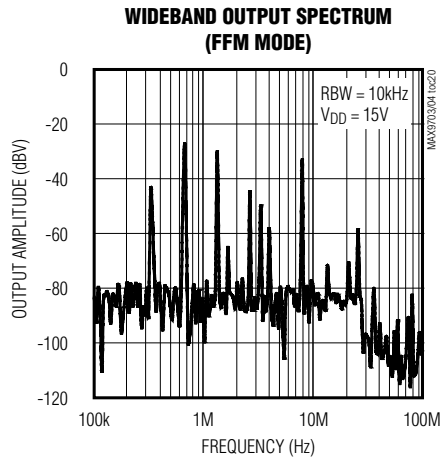
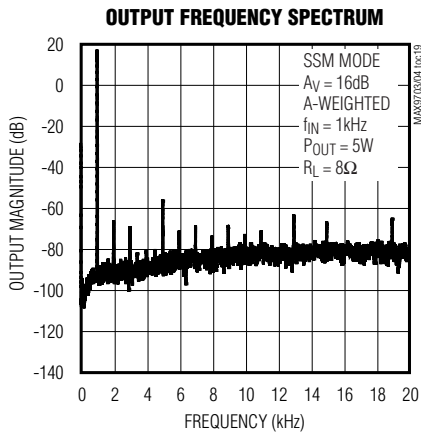

10W Stereo/15W Mono, Filterless, Spread-Spectrum, Class D Amplifiers

Pin Description

PIN		NAME	FUNCTION
MAX9703	MAX9704		
1, 2, 23, 24	1, 2, 23, 24	PGND	Power Ground
3, 4, 21, 22	3, 4, 21, 22	V _{DD}	Power-Supply Input
5	5	C1N	Charge-Pump Flying Capacitor Negative Terminal
6	6	C1P	Charge-Pump Flying Capacitor Positive Terminal
7	7	CHOLD	Charge-Pump Hold Capacitor. Connect a 1 μ F capacitor from CHOLD to V _{DD} .
8, 17, 20, 25, 26, 31, 32	8	N.C.	No Connection. Not internally connected.
9	14	REG	6V Internal Regulator Output. Bypass with a 0.01 μ F capacitor to PGND.
10	13	AGND	Analog Ground
11	—	IN-	Negative Input
12	—	IN+	Positive Input
13	12	SS	Soft-Start. Connect a 0.47 μ F capacitor from SS to GND to enable soft-start feature.
14	11	$\overline{\text{SHDN}}$	Active-Low Shutdown. Connect $\overline{\text{SHDN}}$ to GND to disable the device. Connect to V _{DD} for normal operation.
15	17	G1	Gain-Select Input 1
16	18	G2	Gain-Select Input 2
18	19	FS1	Frequency-Select Input 1
19	20	FS2	Frequency-Select Input 2
27, 28	—	OUT-	Negative Audio Output
29, 30	—	OUT+	Positive Audio Output
—	9	INL-	Left-Channel Negative Input
—	10	INL+	Left-Channel Positive Input
—	15	INR-	Right-Channel Negative Input
—	16	INR+	Right-Channel Positive Input
—	25, 26	OUTR-	Right-Channel Negative Audio Output
—	27, 28	OUTR+	Right-Channel Positive Audio Output
—	29, 30	OUTL-	Left-Channel Negative Audio Output
—	31, 32	OUTL+	Left-Channel Positive Audio Output
—	—	EP	Exposed Paddle. Connect to GND.

MAX9703/MAX9704

10W Stereo/15W Mono, Filterless, Spread-Spectrum, Class D Amplifiers

MAX9703/MAX9704

Detailed Description

The MAX9703/MAX9704 filterless, Class D audio power amplifiers feature several improvements to switch-mode amplifier technology. The MAX9703 is a mono amplifier, the MAX9704 is a stereo amplifier. These devices offer Class AB performance with Class D efficiency, while occupying minimal board space. A unique filterless modulation scheme and spread-spectrum switching mode create a compact, flexible, low-noise, efficient audio power amplifier. The differential input architecture reduces common-mode noise pickup, and can be used without input-coupling capacitors. The devices can also be configured as a single-ended input amplifier.

Comparators monitor the device inputs and compare the complementary input voltages to the triangle waveform. The comparators trip when the input magnitude of the triangle exceeds their corresponding input voltage.

Operating Modes

Fixed-Frequency Modulation (FFM) Mode

The MAX9703/MAX9704 feature three FFM modes with different switching frequencies (Table 1). In FFM mode, the frequency spectrum of the Class D output consists of the fundamental switching frequency and its associated harmonics (see the Wideband FFT graph in the *Typical Operating Characteristics*). The MAX9703/MAX9704 allow the switching frequency to be changed by $\pm 35\%$, should the frequency of one or more of the harmonics fall in a sensitive band. This can be done at any time and does not affect audio reproduction.

Spread-Spectrum Modulation (SSM) Mode

The MAX9703/MAX9704 feature a unique, patented spread-spectrum mode that flattens the wideband spectral components, improving EMI emissions that

Table 1. Operating Modes

FS1	FS2	SWITCHING MODE (kHz)
L	L	670
L	H	940
H	L	470
H	H	670 $\pm 7\%$

may be radiated by the speaker and cables. This mode is enabled by setting FS1 = FS2 = H. In SSM mode, the switching frequency varies randomly by $\pm 7\%$ around the center frequency (670kHz). The modulation scheme remains the same, but the period of the triangle waveform changes from cycle to cycle. Instead of a large amount of spectral energy present at multiples of the switching frequency, the energy is now spread over a bandwidth that increases with frequency. Above a few megahertz, the wideband spectrum looks like white noise for EMI purposes (see Figure 1).

Efficiency

Efficiency of a Class D amplifier is attributed to the region of operation of the output stage transistors. In a Class D amplifier, the output transistors act as current-steering switches and consume negligible additional power. Any power loss associated with the Class D output stage is mostly due to the I^2R loss of the MOSFET on-resistance, and quiescent current overhead.

The theoretical best efficiency of a linear amplifier is 78%; however, that efficiency is only exhibited at peak output powers. Under normal operating levels (typical music reproduction levels), efficiency falls below 30%, whereas the MAX9704 still exhibits $>78\%$ efficiency under the same conditions (Figure 2).

10W Stereo/15W Mono, Filterless, Spread-Spectrum, Class D Amplifiers

MAX9703/MAX9704

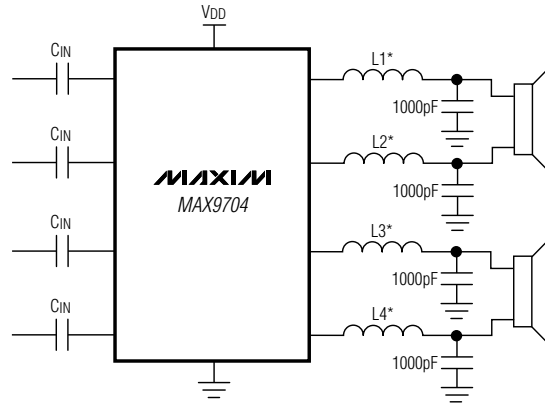

*L1-L4 = 0.05Ω DCR, 70Ω AT 100MHz, 3A FAIR RITE FERRITE BEAD (2512067007Y3).

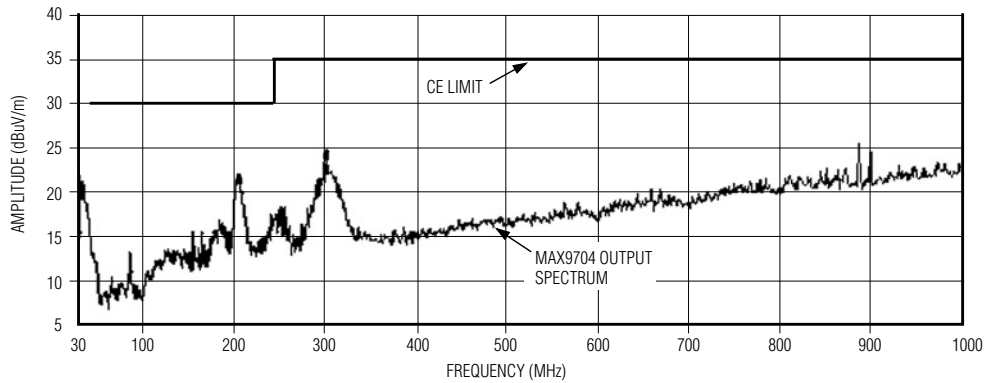

Figure 1. MAX9704 EMI Spectrum, 9in PC Board trace, 3in Twisted-Pair Speaker Cable

10W Stereo/15W Mono, Filterless, Spread-Spectrum, Class D Amplifiers

MAX9703/MAX9704

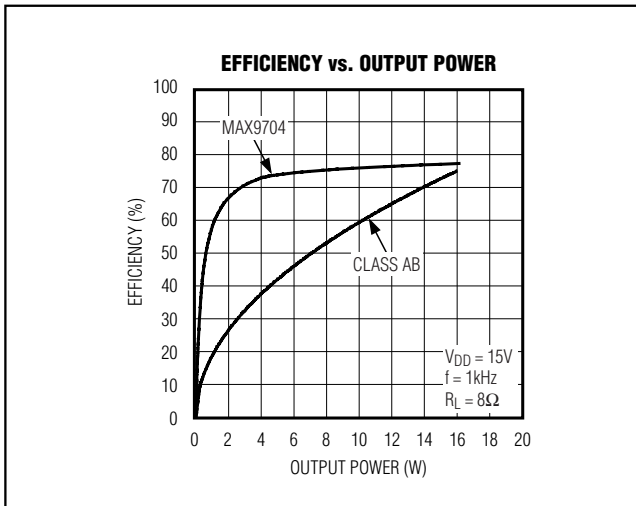

Figure 2. MAX9704 Efficiency vs. Class AB Efficiency

Shutdown

The MAX9703/MAX9704 have a shutdown mode that reduces power consumption and extends battery life. Driving $\overline{\text{SHDN}}$ low places the device in low-power (0.2 μA) shutdown mode. Connect $\overline{\text{SHDN}}$ to a logic high for normal operation.

Click-and-Pop Suppression

The MAX9703/MAX9704 feature comprehensive click-and-pop suppression that eliminates audible transients on startup and shutdown. While in shutdown, the H-bridge is pulled to GND through 330k Ω . During startup, or power-up, the input amplifiers are muted and an internal loop sets the modulator bias voltages to the correct levels, preventing clicks and pops when the H-bridge is subsequently enabled. Following startup, a soft-start function gradually unmutes the input amplifiers. The value of the soft-start capacitor has an impact on the click/pop levels. For optimum performance, C_{SS} should be at least 0.18 μF with a voltage rating of at least 7V.

Mute Function

The MAX9703/MAX9704 features a clickless/popless mute mode. When the device is muted, the outputs stop switching, muting the speaker. Mute only affects the output stage and does not shut down the device. To mute the MAX9703/MAX9704, drive SS to GND by using a MOSFET pulldown (Figure 3). Driving SS to GND during the power-up/down or shutdown/turn-on cycle optimizes click-and-pop suppression.

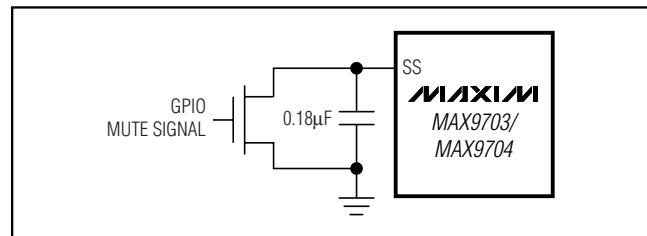

Figure 3. MAX9703/MAX9704 Mute Circuit

Applications Information

Filterless Operation

Traditional class D amplifiers require an output filter to recover the audio signal from the amplifier's PWM output. The filters add cost, increase the solution size of the amplifier, and can decrease efficiency. The traditional PWM scheme uses large differential output swings ($2 \times V_{\text{DD}}$ peak-to-peak) and causes large ripple currents. Any parasitic resistance in the filter components results in a loss of power, lowering the efficiency.

The MAX9703/MAX9704 do not require an output filter. The devices rely on the inherent inductance of the speaker coil and the natural filtering of both the speaker and the human ear to recover the audio component of the square-wave output. Eliminating the output filter results in a smaller, less-costly, more-efficient solution.

Because the frequency of the MAX9703/MAX9704 output is well beyond the bandwidth of most speakers, voice coil movement due to the square-wave frequency is very small. Although this movement is small, a speaker not designed to handle the additional power can be damaged. For optimum results, use a speaker with a series inductance $> 30\mu\text{H}$. Typical 8 Ω speakers exhibit series inductances in the range of 30 μH to 100 μH . Optimum efficiency is achieved with speaker inductances $> 60\mu\text{H}$.

Internal Regulator Output (VREG)

The MAX9703/MAX9704 feature an internal, 6V regulator output (VREG). The MAX9703/MAX9704 REG output pin simplifies system design and reduces system cost by providing a logic voltage high for the MAX9703/MAX9704 logic pins ($G_{\text{--}}$, $\text{FS}_{\text{--}}$). VREG is not available as a logic voltage high in shutdown mode. Do not apply VREG as a 6V potential to surrounding system components. Bypass REG with a 6.3V, 0.01 μF capacitor to GND.

10W Stereo/15W Mono, Filterless, Spread-Spectrum, Class D Amplifiers

Gain Selection

The MAX9703/MAX9704 feature an internally set, logic-selectable gain. The G1 and G2 logic inputs set the gain of the MAX9703/MAX9704 speaker amplifier (Table 2).

Table 2. Gain Selection

G1	G2	GAIN (dB)
0	0	29.6
0	1	19.1
1	0	13
1	1	16

Output Offset

Unlike a Class AB amplifier, the output offset voltage of Class D amplifiers does not noticeably increase quiescent current draw when a load is applied. This is due to the power conversion of the Class D amplifier. For example, an 8mVDC offset across an 8Ω load results in 1mA extra current consumption in a class AB device. In the Class D case, an 8mV offset into 8Ω equates to an additional power drain of 8μW. Due to the high efficiency of the Class D amplifier, this represents an additional quiescent current draw of: $8\mu\text{W}/(V_{\text{DD}}/100 \times \eta)$, which is in the order of a few microamps.

Input Amplifier

Differential Input

The MAX9703/MAX9704 feature a differential input structure, making them compatible with many CODECs, and offering improved noise immunity over a single-ended input amplifier. In devices such as PCs, noisy digital signals can be picked up by the amplifier's input traces. The signals appear at the amplifiers' inputs as common-mode noise. A differential input amplifier amplifies the difference of the two inputs, any signal common to both inputs is canceled.

Single-Ended Input

The MAX9703/MAX9704 can be configured as single-ended input amplifiers by capacitively coupling either input to GND and driving the other input (Figure 4).

Component Selection

Input Filter

An input capacitor, C_{IN} , in conjunction with the input impedance of the MAX9703/MAX9704, forms a high-pass filter that removes the DC bias from an incoming signal. The AC-coupling capacitor allows the amplifier to bias the signal to an optimum DC level. Assuming

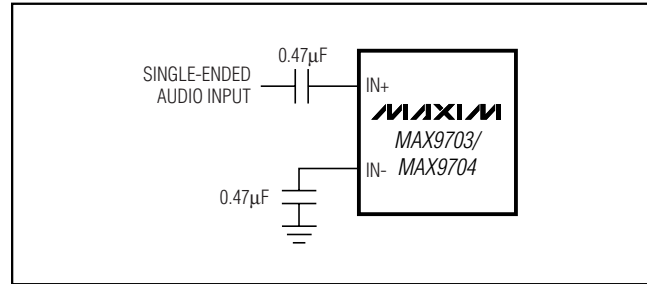

Figure 4. Single-Ended Input

zero-source impedance, the -3dB point of the highpass filter is given by:

$$f_{-3\text{dB}} = \frac{1}{2\pi R_{\text{IN}} C_{\text{IN}}}$$

Choose C_{IN} so $f_{-3\text{dB}}$ is well below the lowest frequency of interest. Setting $f_{-3\text{dB}}$ too high affects the low-frequency response of the amplifier. Use capacitors with dielectrics that have low-voltage coefficients, such as tantalum or aluminum electrolytic. Capacitors with high-voltage coefficients, such as ceramics, may result in increased distortion at low frequencies.

Charge-Pump Capacitor Selection

Use capacitors with an ESR less than 100mΩ for optimum performance. Low-ESR ceramic capacitors minimize the output resistance of the charge pump. For best performance over the extended temperature range, select capacitors with an X7R dielectric.

Flying Capacitor (C1)

The value of the flying capacitor (C_1) affects the load regulation and output resistance of the charge pump. A C_1 value that is too small degrades the device's ability to provide sufficient current drive. Increasing the value of C_1 improves load regulation and reduces the charge-pump output resistance to an extent. Above 1μF, the on-resistance of the switches and the ESR of C_1 and C_2 dominate.

Hold Capacitor (C2)

The output capacitor value and ESR directly affect the ripple at CHOLD. Increasing C_2 reduces output ripple. Likewise, decreasing the ESR of C_2 reduces both ripple and output resistance. Lower capacitance values can be used in systems with low maximum output power levels.

Output Filter

The MAX9703/MAX9704 do not require an output filter and can pass FCC emissions standards with unshielded speaker cables. However, output filtering can be

10W Stereo/15W Mono, Filterless, Spread-Spectrum, Class D Amplifiers

MAX9703/MAX9704

used if a design is failing radiated emissions due to board layout or cable length, or the circuit is near EMI-sensitive devices. Use a ferrite bead filter when radiated frequencies above 10MHz are of concern. Use an LC filter when radiated frequencies below 10MHz are of concern, or when long leads connect the amplifier to the speaker. Refer to the MAX9704 Evaluation Kit schematic for details of this filter.

Sharing Input Sources

In certain systems, a single audio source can be shared by multiple devices (speaker and headphone amplifiers). When sharing inputs, it is common to mute the unused device, rather than completely shutting it down, preventing the unused device inputs from distorting the input signal. Mute the MAX9703/MAX9704 by driving SS low through an open-drain output or MOSFET (see the *System Diagram*). Driving SS low turns off the Class D output stage, but does not affect the input bias levels of the MAX9703/MAX9704. Be aware that during normal operation, the voltage at SS can be up to 7V, depending on the MAX9703/MAX9704 supply.

Supply Bypassing/Layout

Proper power-supply bypassing ensures low distortion operation. For optimum performance, bypass VDD to PGND with a 0.1 μ F capacitor as close to each VDD pin as possible. A low-impedance, high-current power-supply connection to VDD is assumed. Additional bulk capacitance should be added as required depending on the application and power-supply characteristics. AGND and PGND should be star connected to system ground. Refer to the MAX9704 Evaluation Kit for layout guidance.

Class D Amplifier Thermal Considerations

Class D amplifiers provide much better efficiency and thermal performance than a comparable Class AB amplifier. However, the system's thermal performance must be considered with realistic expectations and include consideration of many parameters. This section examines Class D amplifiers using general examples to illustrate good design practices.

Continuous Sine Wave vs. Music

When a Class D amplifier is evaluated in the lab, often a continuous sine wave is used as the signal source. While this is convenient for measurement purposes, it represents a worst-case scenario for thermal loading on the amplifier. It is not uncommon for a Class D amplifier to enter thermal shutdown if driven near maximum output power with a continuous sine wave.

Audio content, both music and voice, has a much lower RMS value relative to its peak output power. Figure 5 shows a sine wave and an audio signal in the time domain. Both are measured for RMS value by the oscilloscope. Although the audio signal has a slightly higher peak value than the sine wave, its RMS value is almost half that of the sine wave. Therefore, while an audio signal may reach similar peaks as a continuous sine wave, the actual thermal impact on the Class D amplifier is highly reduced. If the thermal performance of a system is being evaluated, it is important to use actual audio signals instead of sine waves for testing. If sine waves must be used, the thermal performance will be less than the system's actual capability.

PC Board Thermal Considerations

The exposed pad is the primary route of keeping heat away from the IC. With a bottom-side exposed pad, the PC board and its copper becomes the primary heatsink for the Class D amplifier. Solder the exposed pad to a large copper polygon. Add as much copper as possible from this polygon to any adjacent pin on the Class D amplifier as well as to any adjacent components, provided these connections are at the same potential. These copper paths must be as wide as possible. Each of these paths contributes to the overall thermal capabilities of the system.

The copper polygon to which the exposed pad is attached should have multiple vias to the opposite side of the PC board, where they connect to another copper polygon. Make this polygon as large as possible within the system's constraints for signal routing.

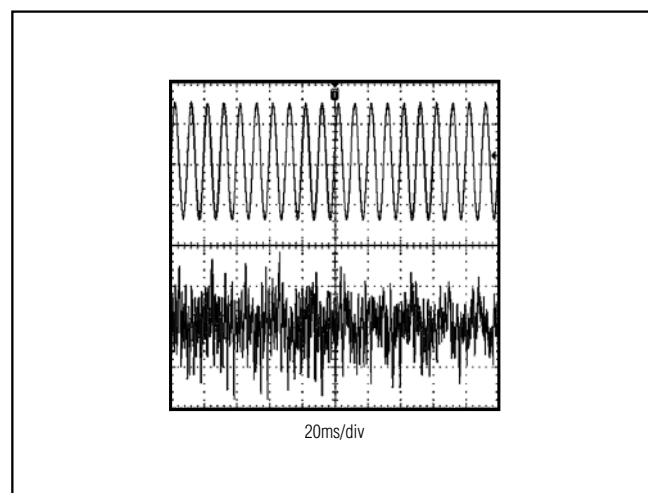

Figure 5. RMS Comparison of Sine Wave vs. Audio Signal

10W Stereo/15W Mono, Filterless, Spread-Spectrum, Class D Amplifiers

MAX9703/MAX9704

Additional improvements are possible if all the traces from the device are made as wide as possible. Although the IC pins are not the primary thermal path of the package, they do provide a small amount. The total improvement would not exceed about 10%, but it could make the difference between acceptable performance and thermal problems.

Auxiliary Heatsinking

If operating in higher ambient temperatures, it is possible to improve the thermal performance of a PC board with the addition of an external heatsink. The thermal resistance to this heatsink must be kept as low as possible to maximize its performance. With a bottom-side exposed pad, the lowest resistance thermal path is on the bottom of the PC board. The topside of the IC is not a significant thermal path for the device, and therefore is not a cost-effective location for a heatsink.

Thermal Calculations

The die temperature of a Class D amplifier can be estimated with some basic calculations. For example, the die temperature is calculated for the below conditions:

- $T_A = +40^\circ\text{C}$
- $P_{\text{OUT}} = 2 \times 8\text{W} = 16\text{W}$
- $R_L = 16\Omega$
- Efficiency (η) = 87%
- $\theta_{\text{JA}} = 27^\circ\text{C/W}$

First, the Class D amplifier's power dissipation must be calculated.

$$P_{\text{DISS}} = \frac{P_{\text{OUT}}}{\eta} - P_{\text{OUT}} = \frac{16\text{W}}{0.87} - 16\text{W} = 2.4\text{W}$$

Then the power dissipation is used to calculate the die temperature, T_C , as follows:

$$\begin{aligned} T_C &= T_A + P_{\text{DISS}} \times \theta_{\text{JA}} \\ &= 40^\circ\text{C} + 2.4\text{W} \times 27^\circ\text{C/W} \\ &= 104.8^\circ\text{C} \end{aligned}$$

Decreasing the ambient temperature or reducing θ_{JA} will improve the die temperature of the MAX9704. θ_{JA} can be reduced by increasing the copper size/weight of the ground plane connected to the exposed paddle of the MAX9704 TQFN package. Additionally, θ_{JA} can be reduced by attaching a heatsink, adding a fan, or mounting a vertical PC board.

Load Impedance

The on-resistance of the MOSFET output stage in Class D amplifiers affects both the efficiency and the peak-current capability. Reducing the peak current into the load reduces the I^2R losses in the MOSFETs, thereby increasing efficiency. To keep the peak currents lower, choose the highest impedance speaker which can still deliver the desired output power within the voltage swing limits of the Class D amplifier and its supply voltage.

Although most loudspeakers are either 4Ω or 8Ω , there are other impedances available which can provide a more thermally efficient solution.

Another consideration is the load impedance across the audio frequency band. A loudspeaker is a complex electromechanical system with a variety of resonances. In other words, an 8Ω speaker is usually only 8Ω impedance within a very narrow range, and often extends well below 8Ω , reducing the thermal efficiency below what is expected. This lower-than-expected impedance can be further reduced when a crossover network is used in a multi-driver audio system.

Optimize MAX9704 Efficiency with Load Impedance and Supply Voltage

To optimize the efficiency of the MAX9703/MAX9704, load the output stage with 12Ω to 16Ω speakers. The MAX9703/MAX9704 exhibits highest efficiency performance when driving higher load impedance (see the *Typical Operating Characteristics*). If a 12Ω to 16Ω load is not available, select a lower supply voltage when driving 6Ω to 10Ω loads.

10W Stereo/15W Mono, Filterless, Spread-Spectrum, Class D Amplifiers

MAX9703/MAX9704

Functional Diagrams

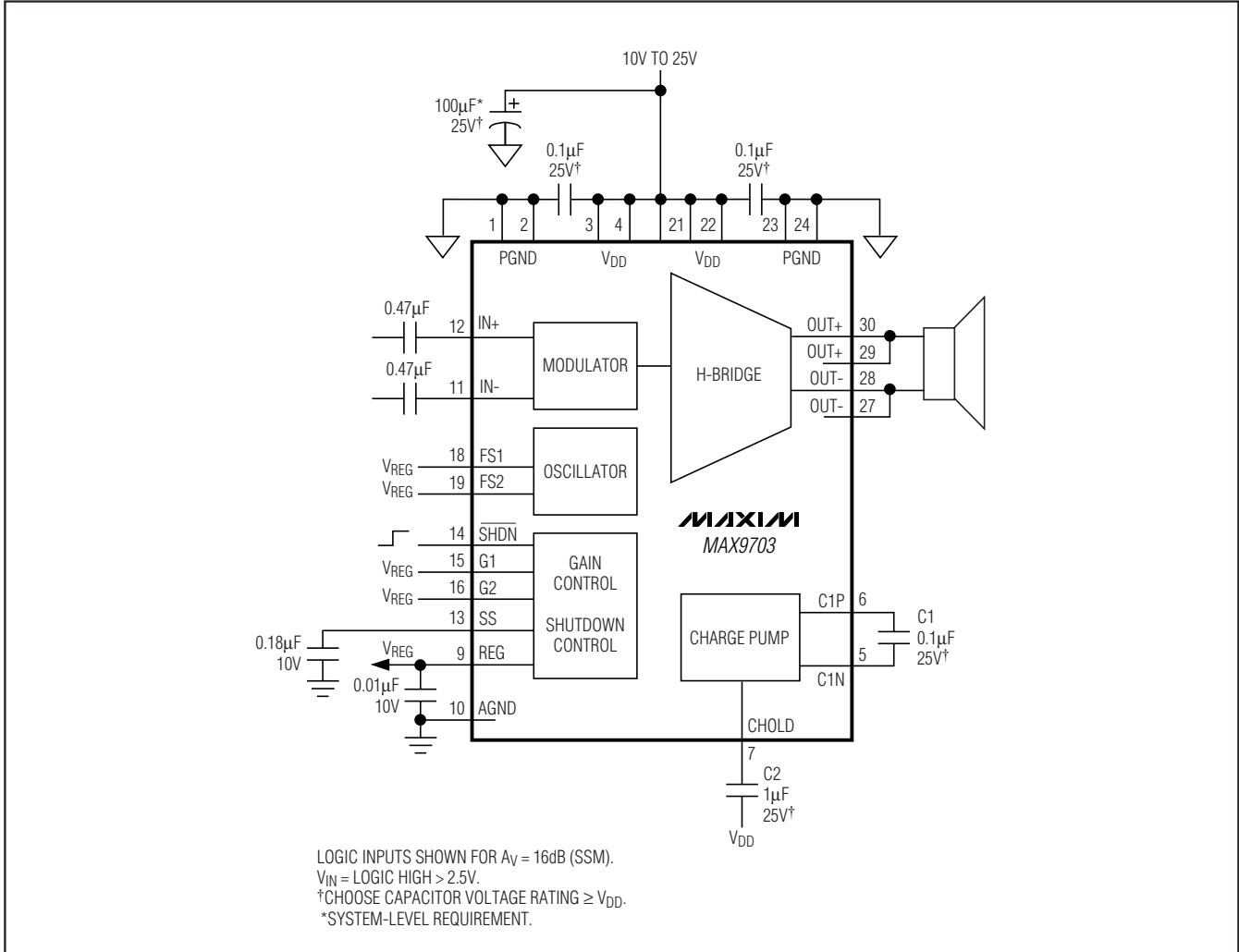

10W Stereo/15W Mono, Filterless, Spread-Spectrum, Class D Amplifiers

Functional Diagrams (continued)

MAX9703/MAX9704

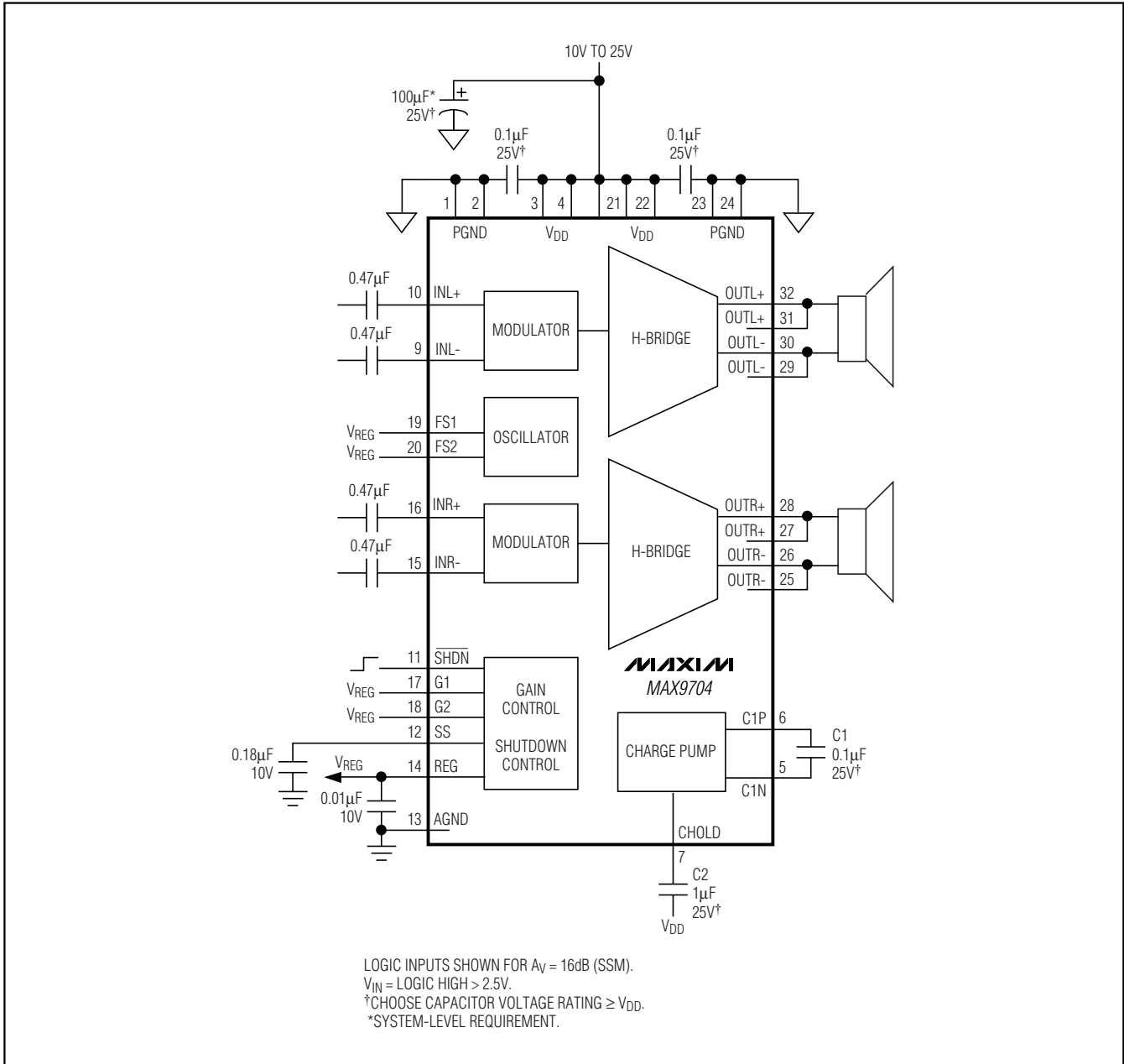

10W Stereo/15W Mono, Filterless, Spread-Spectrum, Class D Amplifiers

MAX9703/MAX9704

System Diagram

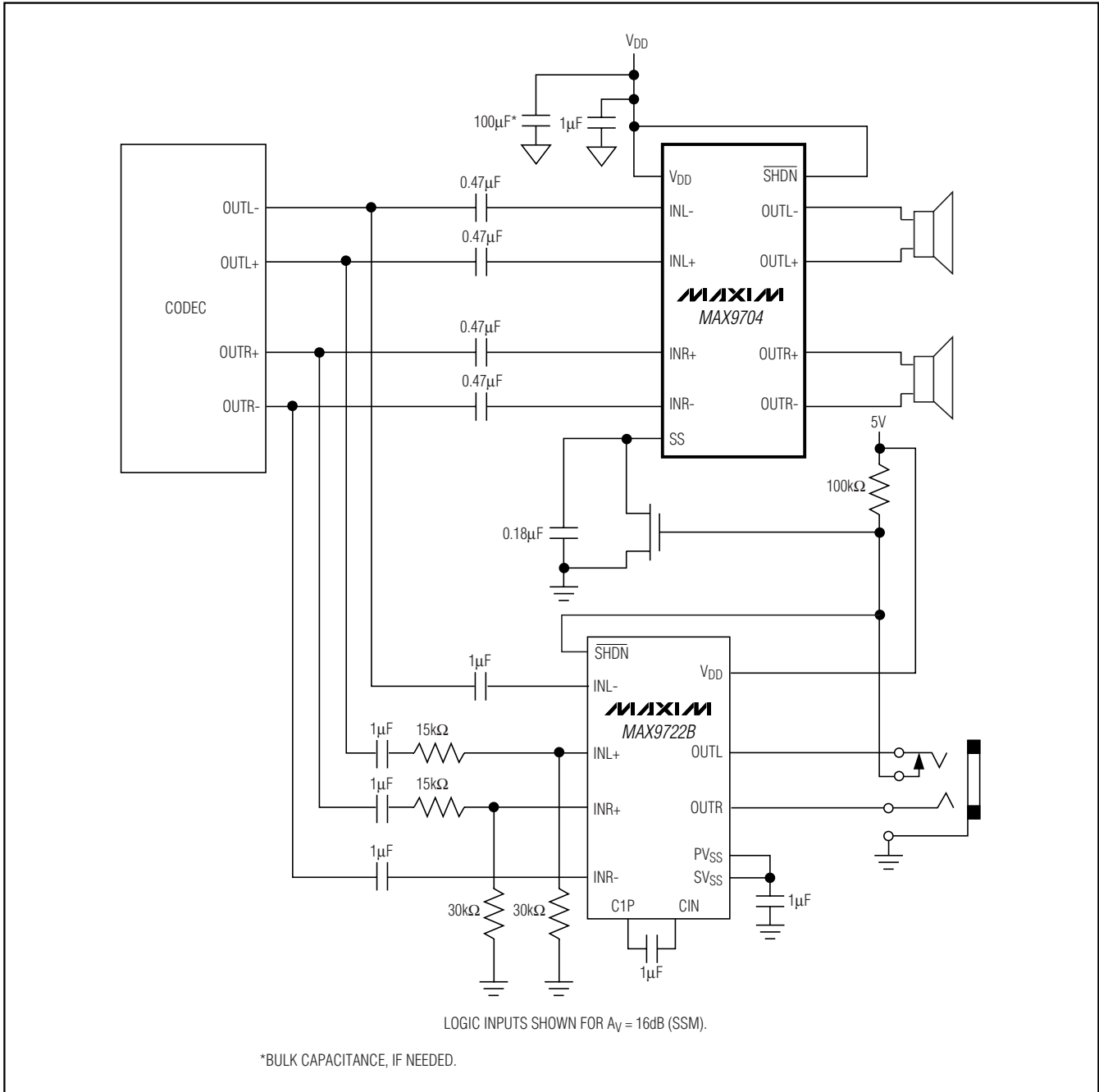

10W Stereo/15W Mono, Filterless, Spread-Spectrum, Class D Amplifiers

Pin Configurations

MAX9703/MAX9704

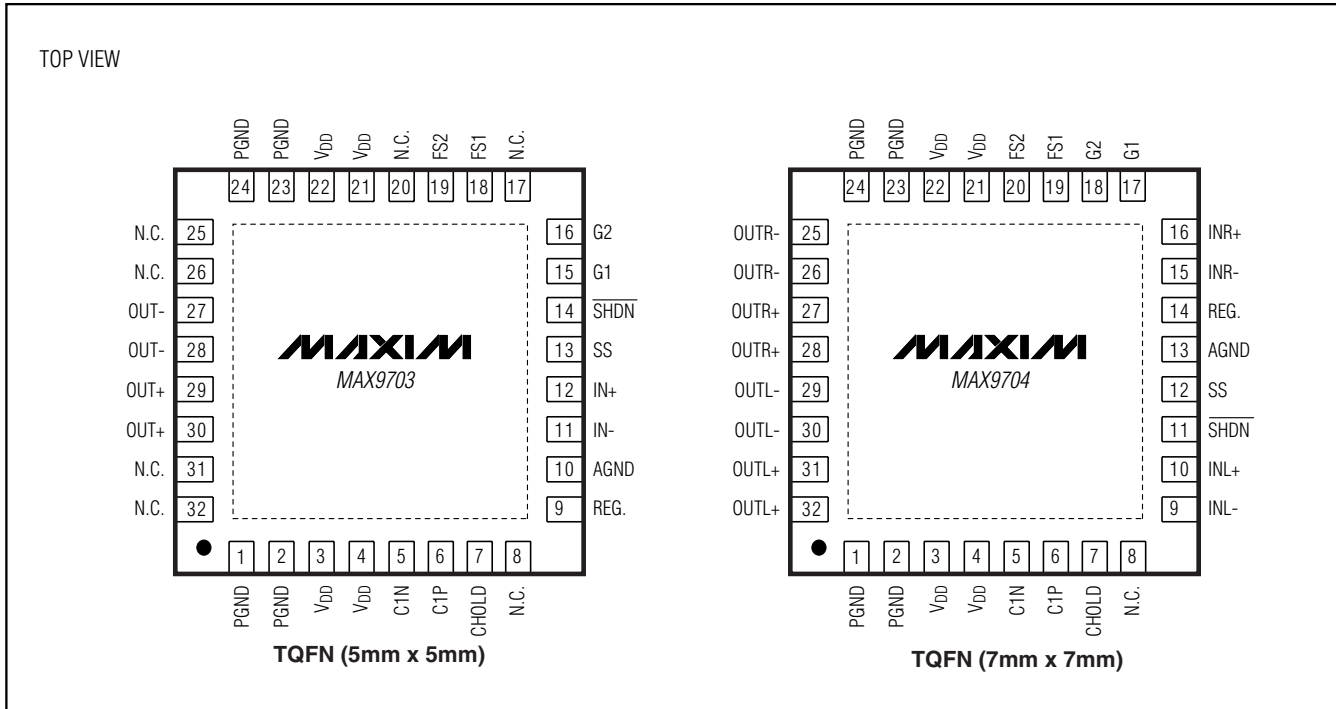

Chip Information

MAX9703 TRANSISTOR COUNT: 3093
 MAX9704 TRANSISTOR COUNT: 4630
 PROCESS: BiCMOS

10W Stereo/15W Mono, Filterless, Spread-Spectrum, Class D Amplifiers

MAX9703/MAX9704

Package Information

(The package drawing(s) in this data sheet may not reflect the most current specifications. For the latest package outline information, go to www.maxim-ic.com/packages.)

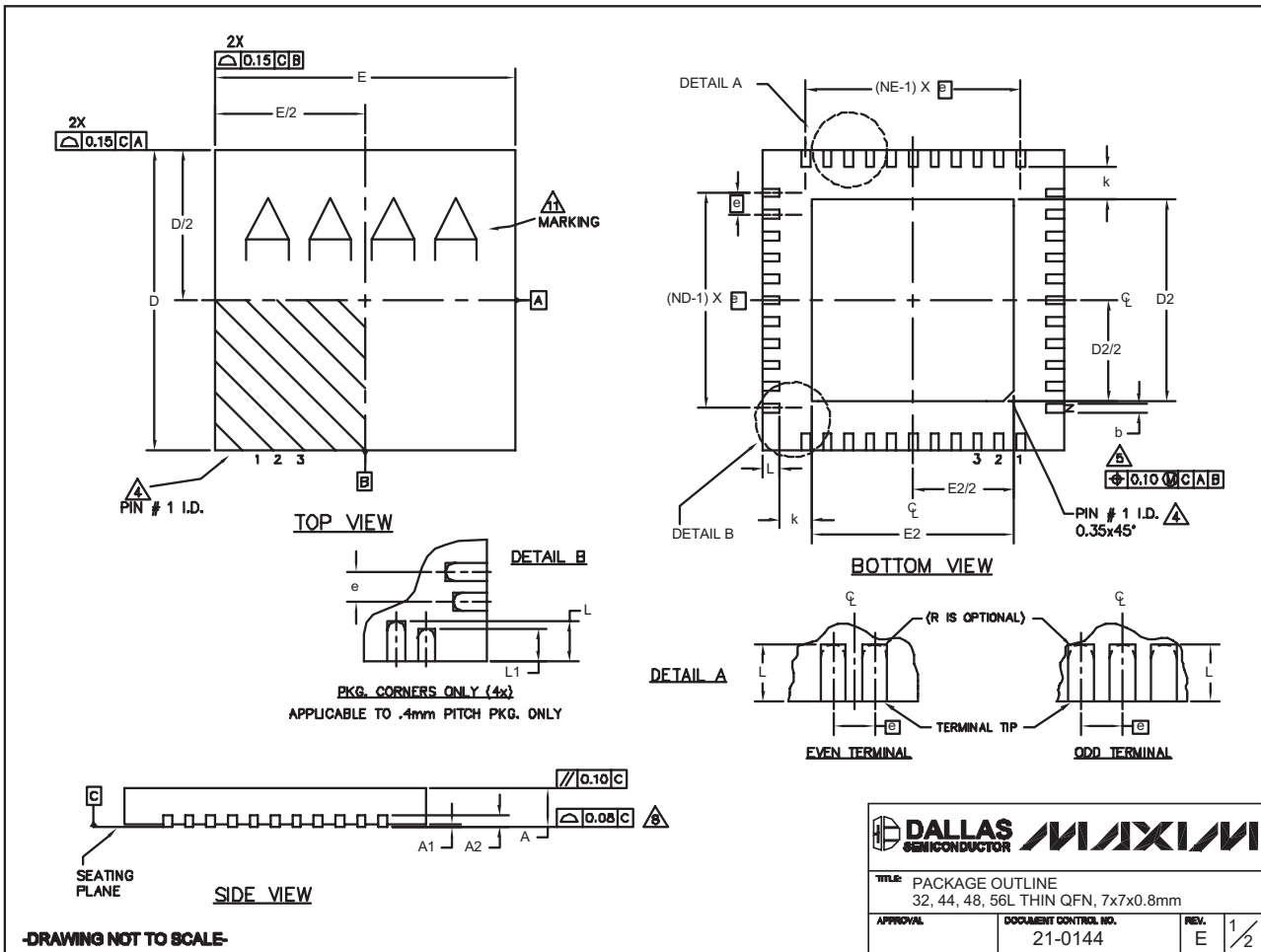

32, 44, 48L QFN.EPS

10W Stereo/15W Mono, Filterless, Spread-Spectrum, Class D Amplifiers

Package Information (continued)

(The package drawing(s) in this data sheet may not reflect the most current specifications. For the latest package outline information, go to www.maxim-ic.com/packages.)

MAX9703/MAX9704

COMMON DIMENSIONS														EXPOSED PAD VARIATIONS													
PKG	32L 7x7			44L 7x7			48L 7x7			CUSTOM PKG. (T4877-1) 48L 7x7			56L 7x7			PKG. CODES	DEPOPULATED LEADS	D2			EZ			JEDEC MO220 REV. C	DOWN BONDS ALLOWED		
	MIN.	NOM.	MAX.	MIN.	NOM.	MAX.	MIN.	NOM.	MAX.	MIN.	NOM.	MAX.	MIN.	NOM.	MAX.			MIN.	NOM.	MAX.	MIN.	NOM.	MAX.				
SYMBOL	MIN.	NOM.	MAX.	MIN.	NOM.	MAX.	MIN.	NOM.	MAX.	MIN.	NOM.	MAX.	MIN.	NOM.	MAX.												
A	0.70	0.75	0.80	0.70	0.75	0.80	0.70	0.75	0.80	0.70	0.75	0.80	0.70	0.75	0.80												
A1	0	0.02	0.05	0	0.02	0.05	0	0.02	0.05	0	0.02	0.05	0	0.02	0.05												
A2	0.20 REF.			0.20 REF.			0.20 REF.			0.20 REF.			0.20 REF.														
b	0.25	0.30	0.35	0.20	0.25	0.30	0.20	0.25	0.30	0.20	0.25	0.30	0.15	0.20	0.25												
D	6.90	7.00	7.10	6.90	7.00	7.10	6.90	7.00	7.10	6.90	7.00	7.10	6.90	7.00	7.10												
E	6.90	7.00	7.10	6.90	7.00	7.10	6.90	7.00	7.10	6.90	7.00	7.10	6.90	7.00	7.10												
e	0.65 BSC.			0.50 BSC.			0.50 BSC.			0.50 BSC.			0.40 BSC.														
k	0.25	-	-	0.25	-	-	0.25	-	-	0.25	-	-	0.25	0.35	0.45												
L	0.45	0.55	0.65	0.45	0.55	0.65	0.30	0.40	0.50	0.45	0.55	0.65	0.40	0.50	0.60												
L1	-	-	-	-	-	-	-	-	-	-	-	-	0.30	0.40	0.50												
N	32			44			48			44			56														
ND	8			11			12			10			14														
NE	8			11			12			12			14														

PKG. CODES	DEPOPULATED LEADS	MIN.	NOM.	MAX.	MIN.	NOM.	MAX.	MIN.	NOM.	MAX.	MIN.	NOM.	MAX.	MIN.	NOM.	MAX.	JEDEC MO220 REV. C	DOWN BONDS ALLOWED
T3277-2	-	4.55	4.70	4.85	4.55	4.70	4.85	-	-	-	-	-	-	-	-	-	-	YES
T3277-3	-	4.55	4.70	4.85	4.55	4.70	4.85	-	-	-	-	-	-	-	-	-	-	NO
T4477-2	-	4.55	4.70	4.85	4.55	4.70	4.85	WKKD-1										YES
T4477-3	-	4.55	4.70	4.85	4.55	4.70	4.85	WKKD-1										YES
T4877-1**	13,24,37,48	4.20	4.30	4.40	4.20	4.30	4.40	-	-	-	-	-	-	-	-	-	-	NO
T4877-3	-	4.95	5.10	5.25	4.95	5.10	5.25	-	-	-	-	-	-	-	-	-	-	YES
T4877-4	-	5.45	5.60	5.63	5.45	5.60	5.63	-	-	-	-	-	-	-	-	-	-	YES
T4877-5	-	2.40	2.50	2.60	2.40	2.50	2.60	-	-	-	-	-	-	-	-	-	-	NO
T4877-6	-	5.45	5.60	5.63	5.45	5.60	5.63	-	-	-	-	-	-	-	-	-	-	NO
T4877-7	-	4.95	5.10	5.25	4.95	5.10	5.25	-	-	-	-	-	-	-	-	-	-	YES
T5677-1	-	5.20	5.30	5.40	5.20	5.30	5.40	-	-	-	-	-	-	-	-	-	-	YES

** NOTE: T4877-1 IS A CUSTOM 48L PKG. WITH 4 LEADS DEPOPULATED. TOTAL NUMBER OF LEADS ARE 44.

NOTES:

- DIMENSIONING & TOLERANCING CONFORM TO ASME Y14.5M-1994.
- ALL DIMENSIONS ARE IN MILLIMETERS. ANGLES ARE IN DEGREES.
- N IS THE TOTAL NUMBER OF TERMINALS.
- THE TERMINAL #1 IDENTIFIER AND TERMINAL NUMBERING CONVENTION SHALL CONFORM TO JESD 95-1 SPP-D12. DETAILS OF TERMINAL #1 IDENTIFIER ARE OPTIONAL, BUT MUST BE LOCATED WITHIN THE ZONE INDICATED. THE TERMINAL #1 IDENTIFIER MAY BE EITHER A MOLD OR MARKED FEATURE.
- DIMENSION b APPLIES TO METALLIZED TERMINAL AND IS MEASURED BETWEEN 0.25 mm AND 0.30 mm FROM TERMINAL TIP.
- ND AND NE REFER TO THE NUMBER OF TERMINALS ON EACH D AND E SIDE RESPECTIVELY.
- DEPOPULATION IS POSSIBLE IN A SYMMETRICAL FASHION.
- COPLANARITY APPLIES TO THE EXPOSED HEAT SINK SLUG AS WELL AS THE TERMINALS.
- DRAWING CONFORMS TO JEDEC MO220 EXCEPT THE EXPOSED PAD DIMENSIONS OF T4877-1/-3/-4/-5/-6 & T5677-1.
- WARPAGE SHALL NOT EXCEED 0.10 mm.
- MARKING IS FOR PACKAGE ORIENTATION REFERENCE ONLY
- NUMBER OF LEADS SHOWN ARE FOR REFERENCE ONLY

-DRAWING NOT TO SCALE-

TITLE: PACKAGE OUTLINE 32, 44, 48, 56L THIN QFN, 7x7x0.8mm	
APPROVAL	DOCUMENT CONTROL NO. 21-0144
REV.	E 2/2

10W Stereo/15W Mono, Filterless, Spread-Spectrum, Class D Amplifiers

MAX9703/MAX9704

Package Information (continued)

(The package drawing(s) in this data sheet may not reflect the most current specifications. For the latest package outline information, go to www.maxim-ic.com/packages.)

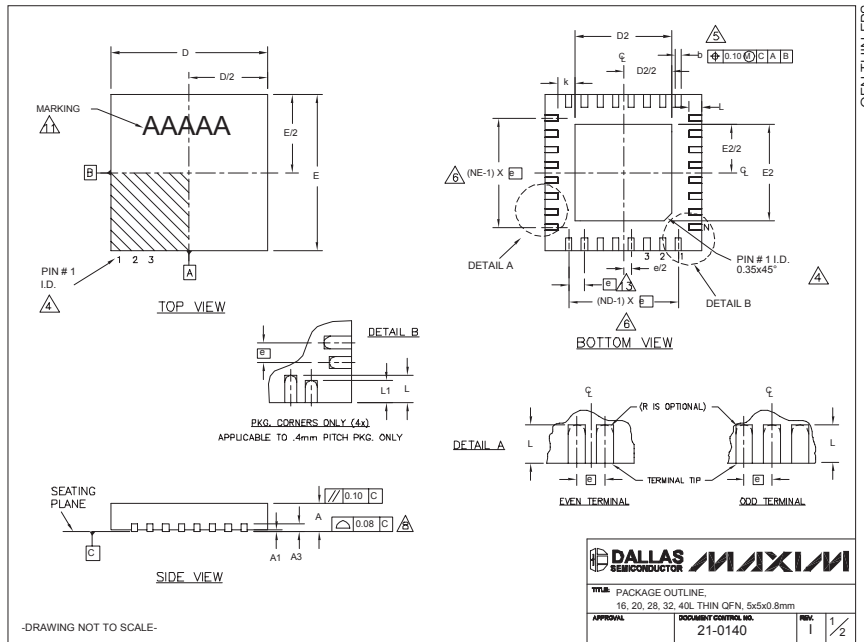

COMMON DIMENSIONS

PKG. SYMBOL	16L 5x5			20L 5x5			28L 5x5			32L 5x5			40L 5x5		
	MIN.	NOM.	MAX.	MIN.	NOM.	MAX.	MIN.	NOM.	MAX.	MIN.	NOM.	MAX.	MIN.	NOM.	MAX.
A	0.70	0.75	0.80	0.70	0.75	0.80	0.70	0.75	0.80	0.70	0.75	0.80	0.70	0.75	0.80
A1	0	0.02	0.05	0	0.02	0.05	0	0.02	0.05	0	0.02	0.05	0	0.02	0.05
A3	0.20 REF.			0.20 REF.			0.20 REF.			0.20 REF.			0.20 REF.		
b	0.25	0.30	0.35	0.25	0.30	0.35	0.20	0.25	0.30	0.20	0.25	0.30	0.15	0.20	0.25
D	4.90	5.00	5.10	4.90	5.00	5.10	4.90	5.00	5.10	4.90	5.00	5.10	4.90	5.00	5.10
E	4.90	5.00	5.10	4.90	5.00	5.10	4.90	5.00	5.10	4.90	5.00	5.10	4.90	5.00	5.10
e	0.80 BSC.			0.65 BSC.			0.50 BSC.			0.50 BSC.			0.40 BSC.		
k	0.25	-	-	0.25	-	-	0.25	-	-	0.25	-	-	0.25	0.35	0.45
L	0.30	0.40	0.50	0.45	0.55	0.65	0.45	0.55	0.65	0.30	0.40	0.50	0.40	0.50	0.60
L1	-	-	-	-	-	-	-	-	-	-	-	-	0.30	0.40	0.50
N	16			20			28			32			40		
ND	4			5			7			8			10		
NE	4			5			7			8			10		
JEDEC	WHHB			WHHC			WHHD-1			WHHD-2			----		

EXPOSED PAD VARIATIONS

PKG. CODES	D2			E2			L	DOWN BONDS ALLOWED
	MIN.	NOM.	MAX.	MIN.	NOM.	MAX.		
T1655-2	3.00	3.10	3.20	3.00	3.10	3.20	±0.15	YES
T1655-3	3.00	3.10	3.20	3.00	3.10	3.20	**	NO
T1655N-1	3.00	3.10	3.20	3.00	3.10	3.20	**	NO
T2055-3	3.00	3.10	3.20	3.00	3.10	3.20	**	YES
T2055-4	3.00	3.10	3.20	3.00	3.10	3.20	**	NO
T2055-5	3.15	3.25	3.35	3.15	3.25	3.35	0.40	YES
T2855-3	3.15	3.25	3.35	3.15	3.25	3.35	**	YES
T2855-4	2.80	2.70	2.80	2.80	2.70	2.80	**	YES
T2855-5	2.80	2.70	2.80	2.80	2.70	2.80	**	NO
T2855-6	3.15	3.25	3.35	3.15	3.25	3.35	**	NO
T2855-7	2.80	2.70	2.80	2.80	2.70	2.80	**	YES
T2855-8	3.15	3.25	3.35	3.15	3.25	3.35	0.40	YES
T2855N-1	3.15	3.25	3.35	3.15	3.25	3.35	**	NO
T3255-3	3.00	3.10	3.20	3.00	3.10	3.20	**	YES
T3255-4	3.00	3.10	3.20	3.00	3.10	3.20	**	NO
T3255-5	3.00	3.10	3.20	3.00	3.10	3.20	**	YES
T3255N-1	3.00	3.10	3.20	3.00	3.10	3.20	**	NO
T4055-1	3.20	3.30	3.40	3.20	3.30	3.40	**	YES

- NOTES:
- DIMENSIONING & TOLERANCING CONFORM TO ASME Y14.5M-1994.
 - ALL DIMENSIONS ARE IN MILLIMETERS. ANGLES ARE IN DEGREES.
 - N IS THE TOTAL NUMBER OF TERMINALS.
 - THE TERMINAL #1 IDENTIFIER AND TERMINAL NUMBERING CONVENTION SHALL CONFORM TO JEDEC 95-1 SPP-012. DETAILS OF TERMINAL #1 IDENTIFIER ARE OPTIONAL, BUT MUST BE LOCATED WITHIN THE ZONE INDICATED. THE TERMINAL #1 IDENTIFIER MAY BE EITHER A MOLD OR MARKED FEATURE.
 - DIMENSION b APPLIES TO METALLIZED TERMINAL AND IS MEASURED BETWEEN 0.25 mm AND 0.30 mm FROM TERMINAL TIP.
 - ND AND NE REFER TO THE NUMBER OF TERMINALS ON EACH D AND E SIDE RESPECTIVELY.
 - DEPOPULATION IS POSSIBLE IN A SYMMETRICAL FASHION.
 - COPLANARITY APPLIES TO THE EXPOSED HEAT SINK SLUG AS WELL AS THE TERMINALS.
 - DRAWING CONFORMS TO JEDEC MO220, EXCEPT EXPOSED PAD DIMENSION FOR T2855-3 AND T2855-6.
 - WARPAGE SHALL NOT EXCEED 0.10 mm.
 - MARKING IS FOR PACKAGE ORIENTATION REFERENCE ONLY.
 - NUMBER OF LEADS SHOWN ARE FOR REFERENCE ONLY.
 - LEAD CENTERLINES TO BE AT TRUE POSITION AS DEFINED BY BASIC DIMENSION "e", ±0.05.

DALLAS SEMICONDUCTOR MAXIM

TITLE: PACKAGE OUTLINE.
16, 20, 28, 32, 40L THIN OFN, 5x5x0.8mm

APPROVAL: _____ DOCUMENT CONTROL NO. 21-0140 REV. I 2/2

10W Stereo/15W Mono, Filterless, Spread-Spectrum, Class D Amplifiers

Package Information (continued)

(The package drawing(s) in this data sheet may not reflect the most current specifications. For the latest package outline information, go to www.maxim-ic.com/packages.)

MAX9703/MAX9704

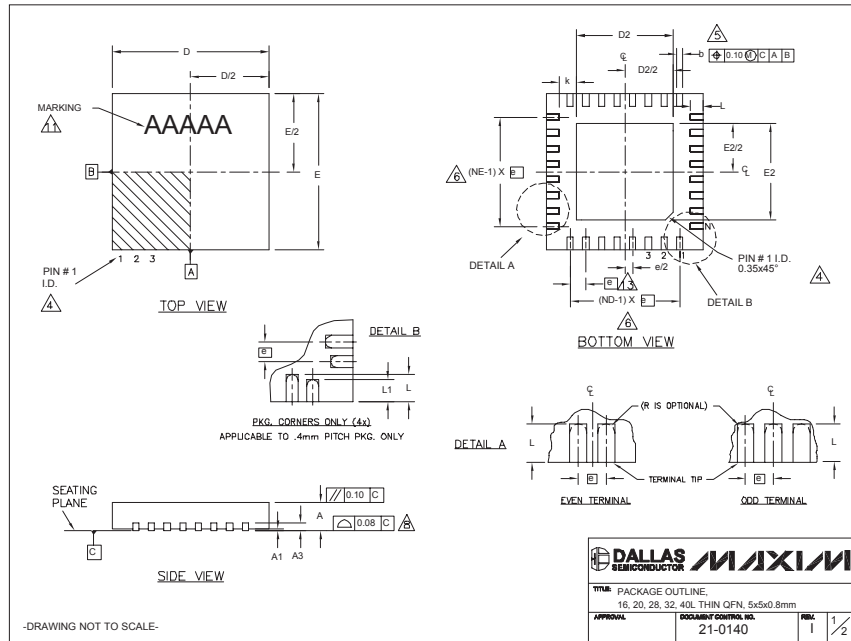

COMMON DIMENSIONS															
PKG.	16L 5x5			20L 5x5			28L 5x5			32L 5x5			40L 5x5		
SYMBOL	MIN.	NOM.	MAX.	MIN.	NOM.	MAX.	MIN.	NOM.	MAX.	MIN.	NOM.	MAX.	MIN.	NOM.	MAX.
A	0.70	0.75	0.80	0.70	0.75	0.80	0.70	0.75	0.80	0.70	0.75	0.80	0.70	0.75	0.80
A1	0	0.02	0.05	0	0.02	0.05	0	0.02	0.05	0	0.02	0.05	0	0.02	0.05
A3	0.20 REF.			0.20 REF.			0.20 REF.			0.20 REF.			0.20 REF.		
b	0.25	0.30	0.35	0.25	0.30	0.35	0.20	0.25	0.30	0.20	0.25	0.30	0.15	0.20	0.25
D	4.90	5.00	5.10	4.90	5.00	5.10	4.90	5.00	5.10	4.90	5.00	5.10	4.90	5.00	5.10
E	4.90	5.00	5.10	4.90	5.00	5.10	4.90	5.00	5.10	4.90	5.00	5.10	4.90	5.00	5.10
e	0.80 BSC.			0.65 BSC.			0.50 BSC.			0.50 BSC.			0.40 BSC.		
k	0.25	-	0.25	-	0.25	-	0.25	-	0.25	-	0.25	-	0.25	0.35	0.45
L	0.30	0.40	0.50	0.45	0.55	0.65	0.45	0.55	0.65	0.30	0.40	0.50	0.40	0.50	0.60
L1	-	-	-	-	-	-	-	-	-	-	-	-	0.30	0.40	0.50
N	16			20			28			32			40		
ND	4			5			7			8			10		
NE	4			5			7			8			10		
JEDEC	WHHB			WHHC			WHHD-1			WHHD-2			---		

EXPOSED PAD VARIATIONS												
PKG. CODES	D2			E2			L	DOWN BONDS ALLOWED				
	MIN.	NOM.	MAX.	MIN.	NOM.	MAX.			±0.15			
T1655-2	3.00	3.10	3.20	3.00	3.10	3.20	**	YES				
T1655-3	3.00	3.10	3.20	3.00	3.10	3.20	**	NO				
T1655N-1	3.00	3.10	3.20	3.00	3.10	3.20	**	NO				
T2055-3	3.00	3.10	3.20	3.00	3.10	3.20	**	YES				
T2055-4	3.00	3.10	3.20	3.00	3.10	3.20	**	NO				
T2055-5	3.15	3.25	3.35	3.15	3.25	3.35	0.40	YES				
T2855-3	3.15	3.25	3.35	3.15	3.25	3.35	**	YES				
T2855-4	2.60	2.70	2.80	2.60	2.70	2.80	**	YES				
T2855-5	2.60	2.70	2.80	2.60	2.70	2.80	**	NO				
T2855-6	3.15	3.25	3.35	3.15	3.25	3.35	**	NO				
T2855-7	2.60	2.70	2.80	2.60	2.70	2.80	**	YES				
T2855-8	3.15	3.25	3.35	3.15	3.25	3.35	0.40	YES				
T2855N-1	3.15	3.25	3.35	3.15	3.25	3.35	**	NO				
T3255-3	3.00	3.10	3.20	3.00	3.10	3.20	**	YES				
T3255-4	3.00	3.10	3.20	3.00	3.10	3.20	**	NO				
T3255-5	3.00	3.10	3.20	3.00	3.10	3.20	**	YES				
T3255N-1	3.00	3.10	3.20	3.00	3.10	3.20	**	NO				
T4055-1	3.20	3.30	3.40	3.20	3.30	3.40	**	YES				

**SEE COMMON DIMENSIONS TABLE

- NOTES:
- DIMENSIONING & TOLERANCING CONFORM TO ASME Y14.5M-1994.
 - ALL DIMENSIONS ARE IN MILLIMETERS, ANGLES ARE IN DEGREES.
 - N IS THE TOTAL NUMBER OF TERMINALS.
- ▲ THE TERMINAL #1 IDENTIFIER AND TERMINAL NUMBERING CONVENTION SHALL CONFORM TO JEDEC 95-1 SPP-012. DETAILS OF TERMINAL #1 IDENTIFIER ARE OPTIONAL, BUT MUST BE LOCATED WITHIN THE ZONE INDICATED. THE TERMINAL #1 IDENTIFIER MAY BE EITHER A MOLD OR MARKED FEATURE.
- ▲ DIMENSION b APPLIES TO METALLIZED TERMINAL AND IS MEASURED BETWEEN 0.25 mm AND 0.30 mm FROM TERMINAL TIP.
- ▲ ND AND NE REFER TO THE NUMBER OF TERMINALS ON EACH D AND E SIDE RESPECTIVELY.
7. DEPOPULATION IS POSSIBLE IN A SYMMETRICAL FASHION.
- ▲ COPLANARITY APPLIES TO THE EXPOSED HEAT SINK SLUG AS WELL AS THE TERMINALS.
9. DRAWING CONFORMS TO JEDEC MO220, EXCEPT EXPOSED PAD DIMENSION FOR T2855-3 AND T2855-6.
- ▲ WARPAGE SHALL NOT EXCEED 0.10 mm.
11. MARKING IS FOR PACKAGE ORIENTATION REFERENCE ONLY.
12. NUMBER OF LEADS SHOWN ARE FOR REFERENCE ONLY.
- ▲ LEAD CENTERLINES TO BE AT TRUE POSITION AS DEFINED BY BASIC DIMENSION "e", ±0.05.

Maxim cannot assume responsibility for use of any circuitry other than circuitry entirely embodied in a Maxim product. No circuit patent licenses are implied. Maxim reserves the right to change the circuitry and specifications without notice at any time.

Maxim Integrated Products, 120 San Gabriel Drive, Sunnyvale, CA 94086 408-737-7600 _____ 21