

Dual, Triple, and Quad Standard-Definition Video Filter Amplifiers with DC-Coupled Input Buffers

General Description

The MAX9583/MAX9584/MAX9585 are small, low-power, multichannel video amplifiers with integrated reconstruction filters. Specially suited for standard-definition video signals, these devices are ideal for a wide range of television, set-top box, and portable applications.

The MAX9583/MAX9584/MAX9585 inputs can be directly connected to the outputs of a video digital-to-analog converter (DAC). The reconstruction filter typically has ± 1 dB passband flatness at 7MHz and 40dB attenuation at 27MHz. The amplifiers have a 2V/V gain and the outputs can be DC-coupled to a 75 Ω load which is the equivalent of two video loads, or AC-coupled to a 150 Ω load.

The MAX9583/MAX9584/MAX9585 operate from a 2.7V to 3.6V single supply and are specified over the -40°C to +125°C automotive temperature range. The MAX9583 is offered in a small, 6-pin thin SOT23 package. The MAX9584 is offered in a small, 8-pin μ MAX[®] package, and the MAX9585 is offered in a small, 10-pin μ MAX package.

Applications

Set-Top Boxes
Televisions
Portable

Pin Configurations and Selector Guide located at end of data sheet.

μ MAX is a registered trademark of Maxim Integrated Products, Inc.

Features

- ◆ Dual- (MAX9583), Triple- (MAX9584), and Quad- (MAX9585) Channel Devices
- ◆ 7MHz, ± 1 dB Passband
- ◆ 40dB Attenuation at 27MHz
- ◆ Fixed Gain of 2V/V
- ◆ Low Power: 3.5mA per Channel
- ◆ 2.7V to 3.6V Single-Supply Operation
- ◆ Small SOT23 and μ MAX Packages

Ordering Information

PART	PIN-PACKAGE	CHANNELS	PKG CODE
MAX9583AZT+T*	6 Thin SOT23-6	2	Z6+1
MAX9583ALT+T*	6 μ DFN-6	2	L622+1
MAX9584AUA+T	8 μ MAX-8	3	U8+1
MAX9584ALA+T*	8 μ DFN-8	3	L822+1
MAX9585AUB+T	10 μ MAX-10	4	U10+2
MAX9585ATC+*	12 TQFN-EP**	4	T1233+4

Note: All devices are specified over the -40°C to +125°C operating temperature range.

+Denotes a lead-free package.

T = Tape and reel.

*Future product—contact factory for availability.

**EP = Exposed paddle.

Block Diagrams

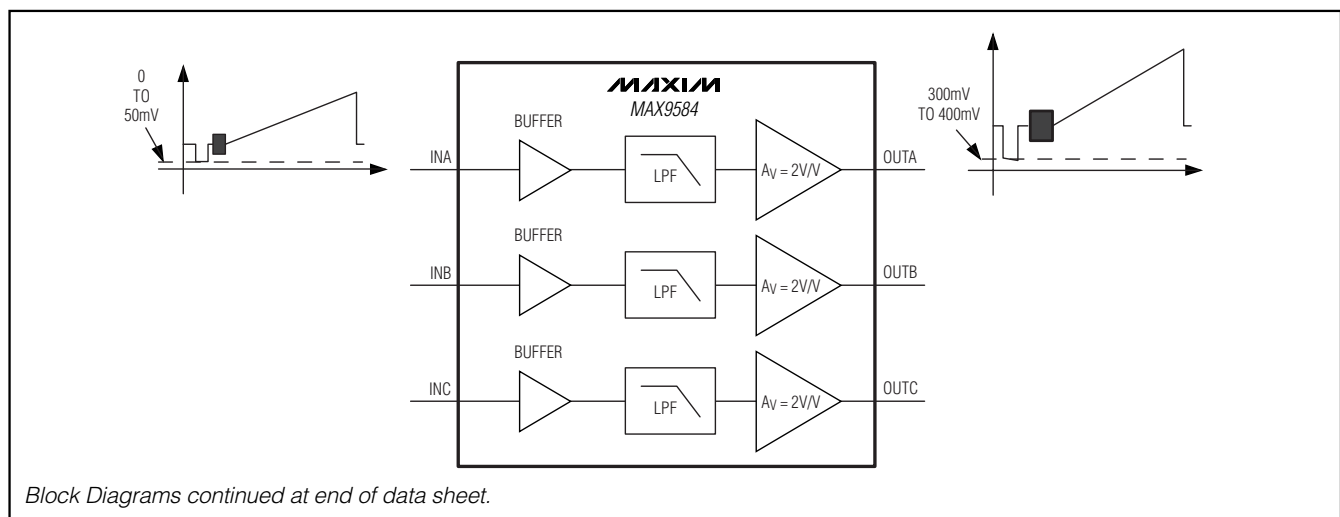

Dual, Triple, and Quad Standard-Definition Video Filter Amplifiers with DC-Coupled Input Buffers

ABSOLUTE MAXIMUM RATINGS

V _{DD} to GND	-0.3V to +4V	8-Pin μ DFN (derate 4.8mW/°C above +70°C)	381mW
IN ₋ to GND	-0.3V to +4V	10-Pin μ MAX (derate 5.6mW/°C above +70°C)	444mW
OUT ₋ Short-Circuit Duration to V _{DD} , GND	Continuous	12-Pin, 3mm x 3mm TQFN (derate 14.7mW/°C above +70°C)	1177mW
Continuous Input Current		Operating Temperature Range	-40°C to +125°C
IN ₋	± 20 mA	Junction Temperature	+150°C
Continuous Power Dissipation (T _A = +70°C)		Storage Temperature Range	-65°C to +150°C
6-Pin Thin SOT23 (derate 9.1mW/°C above +70°C)	727mW	Lead Temperature (soldering, 10s)	+300°C
6-Pin μ DFN (derate 4.5mW/°C above +70°C)	358mW		
8-Pin μ MAX (derate 4.5mW/°C above +70°C)	362mW		

Stresses beyond those listed under "Absolute Maximum Ratings" may cause permanent damage to the device. These are stress ratings only, and functional operation of the device at these or any other conditions beyond those indicated in the operational sections of the specifications is not implied. Exposure to absolute maximum rating conditions for extended periods may affect device reliability.

ELECTRICAL CHARACTERISTICS

(V_{DD} = 3.3V, GND = 0V, R_L = no load, T_A = T_{MIN} to T_{MAX}, unless otherwise noted. Typical values are at T_A = +25°C) (Note 1)

PARAMETER	SYMBOL	CONDITIONS	MIN	TYP	MAX	UNITS	
Supply Voltage Range	V _{DD}	Guaranteed by PSRR	2.7		3.6	V	
Supply Current	I _{DD}	Per channel		3.5	7	mA	
Input Voltage Range	V _{IN}	Guaranteed by DC voltage gain	V _{DD} = 2.7V	0	1.05	V _{P-P}	
			V _{DD} = 3V	0	1.2		
Input Current	I _{IN}	V _{IN} = 0V		0.6	10	μ A	
Input Resistance	R _{IN}			25		M Ω	
DC Voltage Gain (Note 2)	A _v	R _L = 150 Ω to GND	V _{DD} = 2.7V, 0V \leq V _{IN} \leq 1.05V	1.96	2	2.04	V/V
			V _{DD} = 3V, 0V \leq V _{IN} \leq 1.2V	1.96	2	2.04	
DC Gain Matching		Guaranteed by DC voltage gain	-2	0	+2	%	
Output Level		Measured at V _{OUT} , V _{IN} = 0V, R _L = 150 Ω to GND	0.210	0.300	0.410	V	
Output-Voltage Swing			Measured at output, V _{DD} = 2.7V, 0V \leq V _{IN} \leq 1.05V, R _L = 150 Ω to -0.2V	2.1		V _{P-P}	
			Measured at output, V _{DD} = 2.7V, 0V \leq V _{IN} \leq 1.05V, R _L = 150 Ω to V _{DD} /2	2.1			
			Measured at output, V _{DD} = 3V, 0V \leq V _{IN} \leq 1.2V, R _L = 150 Ω to -0.2V	2.4			
			Measured at output, V _{DD} = 3V, 0V \leq V _{IN} \leq 1.2V, R _L = 150 Ω to V _{DD} /2	2.4			
			Measured at output, V _{DD} = 3.135V, 0V \leq V _{IN} \leq 1.05V, R _L = 75 Ω to -0.2V	2.1			
Output Short-Circuit Current		Short to GND (sourcing)	140		mA		
		Short to V _{DD} (sinking)	70				
Output Resistance	R _{OUT}	V _{OUT} = 1.5V, -10mA \leq I _{LOAD} \leq 10mA		0.2		Ω	
Power-Supply Rejection Ratio	PSRR	2.7V \leq V _{DD} \leq 3.6V	48		dB		
		f = 1MHz, 100mV _{P-P}	29				

Dual, Triple, and Quad Standard-Definition Video Filter Amplifiers with DC-Coupled Input Buffers

ELECTRICAL CHARACTERISTICS (continued)

($V_{DD} = 3.3V$, $GND = 0V$, $R_L = \text{no load}$, $T_A = T_{MIN}$ to T_{MAX} , unless otherwise noted. Typical values are at $T_A = +25^\circ C$) (Note 1)

PARAMETER	SYMBOL	CONDITIONS	MIN	TYP	MAX	UNITS
Standard-Definition Reconstruction Filter		$\pm 1\text{dB}$ passband flatness		7		MHz
		$V_{IN} = 1V_{P-P}$, reference frequency is 100kHz	$f = 5.5\text{MHz}$		-0.5	dB
			$f = 8.5\text{MHz}$		-3	
			$f = 27\text{MHz}$		-40	
Differential Gain	DG	5-step modulated staircase of 129mV step size and 286mV peak-to-peak subcarrier amplitude, $f = 4.43\text{MHz}$		0.1		%
Differential Phase	DP	5-step modulated staircase of 129mV step size and 286mV peak-to-peak subcarrier amplitude, $f = 4.43\text{MHz}$		0.4		Degrees
2T Pulse-to-Bar K Rating		$2T = 200\text{ns}$, bar time is $18\mu\text{s}$. The beginning 2.5% and the ending 2.5% of the bar time are ignored		0.6		K%
2T Pulse Response		$2T = 200\text{ns}$		0.2		K%
2T Bar Response		$2T = 200\text{ns}$, bar time is $18\mu\text{s}$. The beginning 2.5% and the ending 2.5% of the bar time are ignored		0.2		K%
Nonlinearity		5-step staircase		0		%
Group Delay Distortion		$100\text{kHz} \leq f \leq 5.5\text{MHz}$, outputs are $2V_{P-P}$		9		ns
Peak Signal to RMS Noise		$100\text{kHz} \leq f \leq 5.5\text{MHz}$		71		dB
Output Impedance		$f = 5.5\text{MHz}$		4.8		Ω
All Hostile Crosstalk		$f = 4.43\text{MHz}$		-64		dB

Note 1: All devices are 100% production tested at $T_A = +25^\circ C$. Specifications over temperature limits are guaranteed by design.

Note 2: Voltage gain (A_V) is a two-point measurement in which the output voltage swing is divided by the input voltage swing.

Typical Operating Characteristics

($V_{DD} = \overline{\text{SHDN}} = 3.3V$, video outputs have $R_L = 150\Omega$ connected to GND, $T_A = +25^\circ C$, unless otherwise noted.)

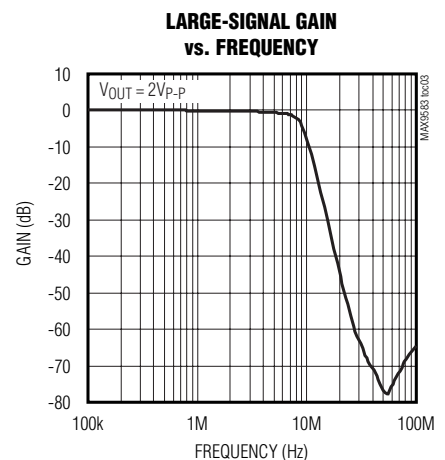
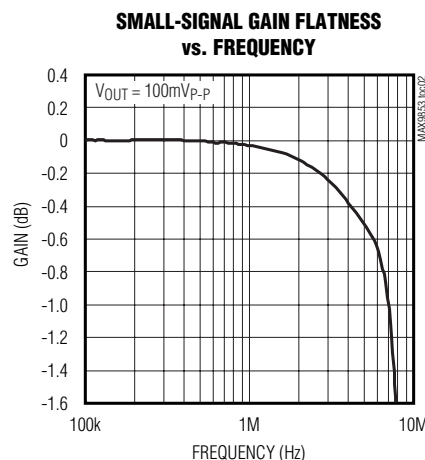
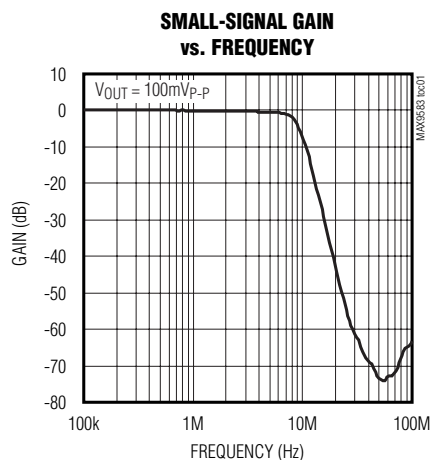

MAX9583/MAX9584/MAX9585

Dual, Triple, and Quad Standard-Definition Video Filter Amplifiers with DC-Coupled Input Buffers

Typical Operating Characteristics (continued)

($V_{DD} = \overline{\text{SHDN}} = 3.3\text{V}$, video outputs have $R_L = 150\Omega$ connected to GND, $T_A = +25^\circ\text{C}$, unless otherwise noted.)

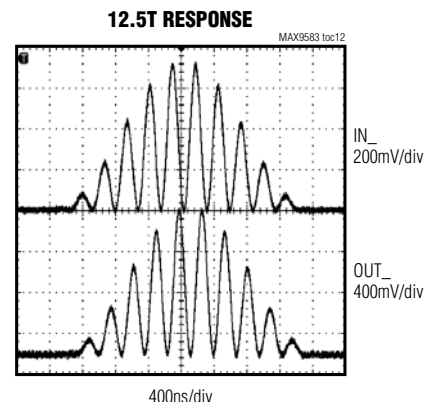
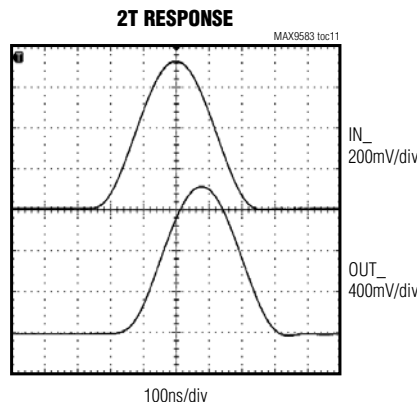
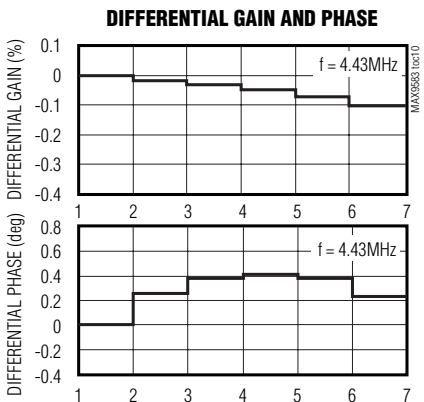
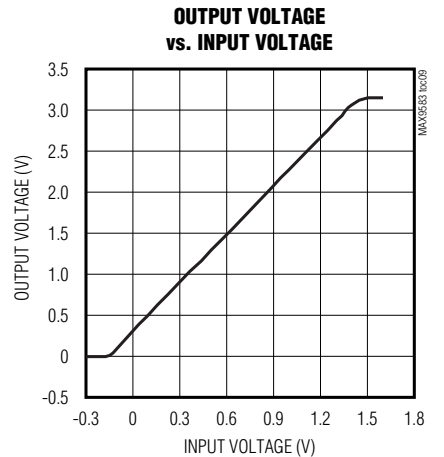
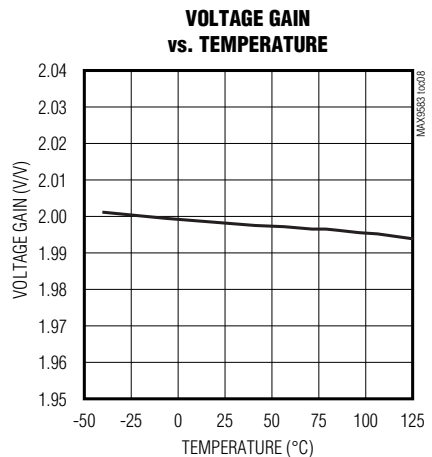
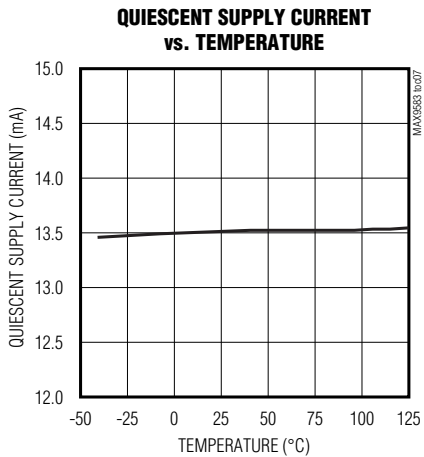
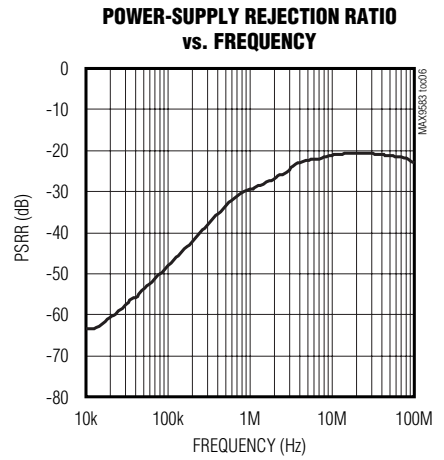
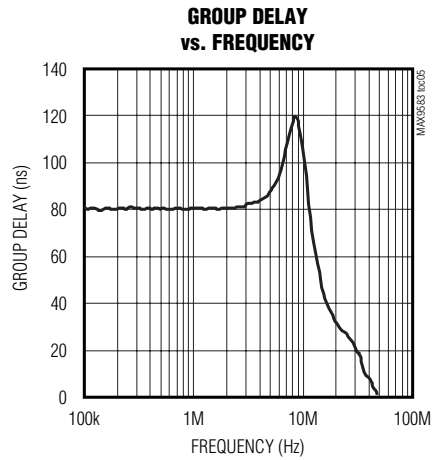
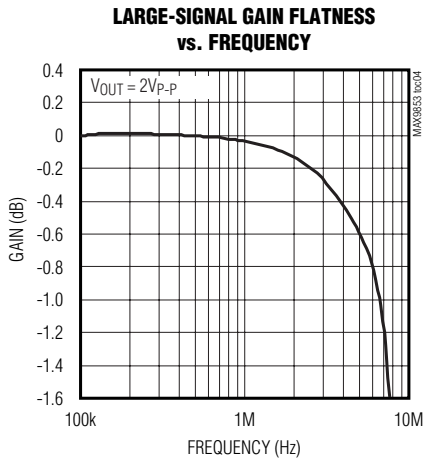

Dual, Triple, and Quad Standard-Definition Video Filter Amplifiers with DC-Coupled Input Buffers

Typical Operating Characteristics (continued)

($V_{DD} = \overline{\text{SHDN}} = 3.3\text{V}$, video outputs have $R_L = 150\Omega$ connected to GND, $T_A = +25^\circ\text{C}$, unless otherwise noted.)

NTC-7 VIDEO TEST SIGNAL ON CVBS OUTPUTS

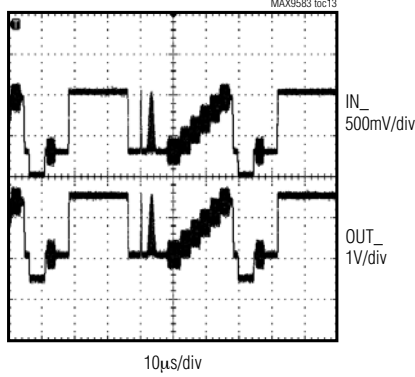

PAL MULTIBURST RESPONSE

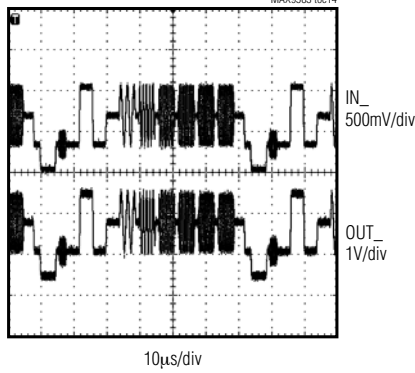

PAL COLOR BARS

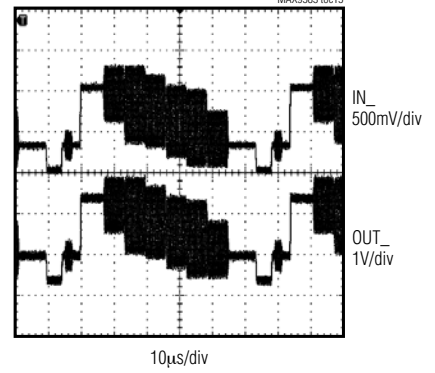

FIELD SQUARE-WAVE RESPONSE

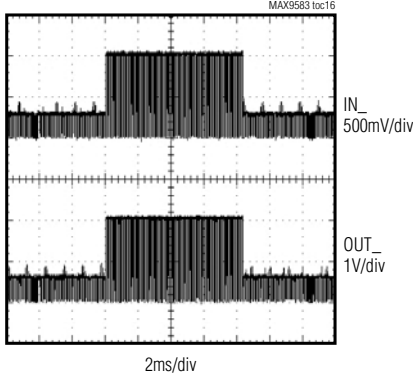

INPUT-TO-INPUT CROSSTALK vs. FREQUENCY

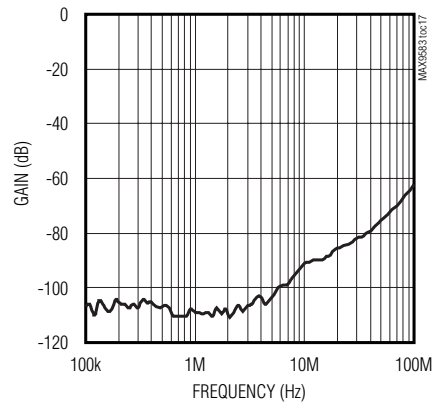

OUTPUT-TO-OUTPUT CROSSTALK vs. FREQUENCY

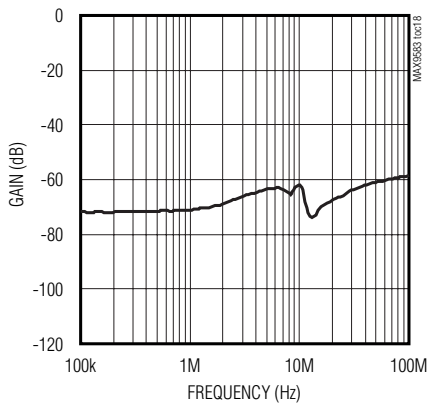

OUTPUT IMPEDANCE vs. FREQUENCY

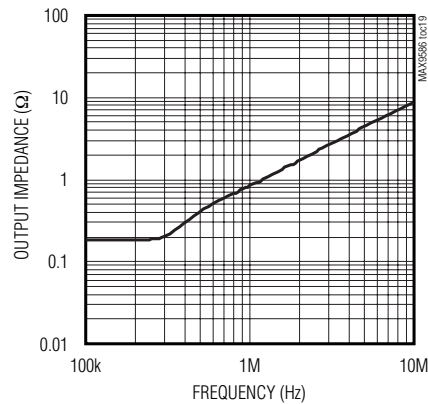

MAX9583/MAX9584/MAX9585

Dual, Triple, and Quad Standard-Definition Video Filter Amplifiers with DC-Coupled Input Buffers

Pin Description

MAX9583		MAX9584		MAX9585		NAME	FUNCTION
6 SOT23	6 μ DFN	8 μ MAX	8 μ DFN	10 μ MAX	12 TQFN		
2	2	4	4	5	7	GND	Ground
3	1	1	1	1	3	INA	Video Input A
1	3	2	2	2	4	INB	Video Input B
—	—	3	3	3	5	INC	Video Input C
—	—	—	—	4	6	IND	Video Input D
4	6	7	7	9	12	OUTA	Video Output A
6	4	6	6	8	11	OUTB	Video Output B
—	—	5	5	7	10	OUTC	Video Output C
—	—	—	—	6	9	OUTD	Video Output D
5	5	8	8	10	1	V _{DD}	Positive Power Supply. Bypass to GND with a 0.1 μ F capacitor.
—	—	—	—	—	2,8	N.C.	No Connection. Not internally connected.
—	—	—	—	—	EP	EP	Exposed Paddle. Connect EP to GND. EP is also internally connected to GND.

Typical Application Circuits

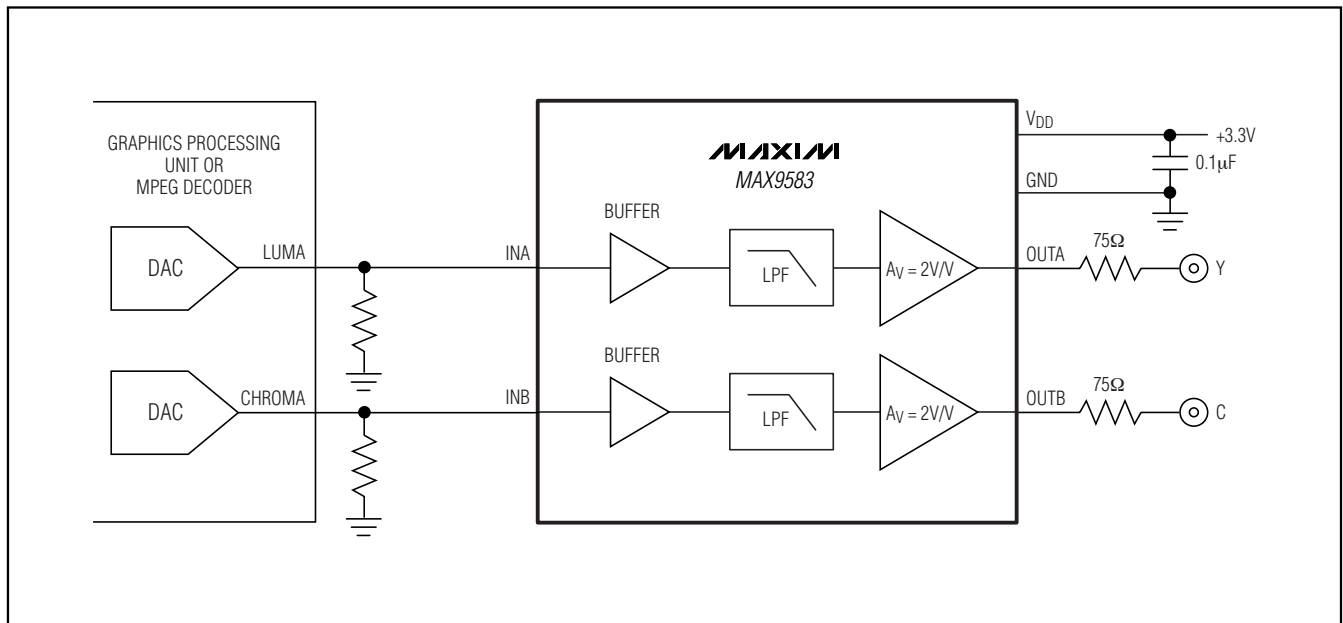

Dual, Triple, and Quad Standard-Definition Video Filter Amplifiers with DC-Coupled Input Buffers

Typical Application Circuits (continued)

MAX9583/MAX9584/MAX9585

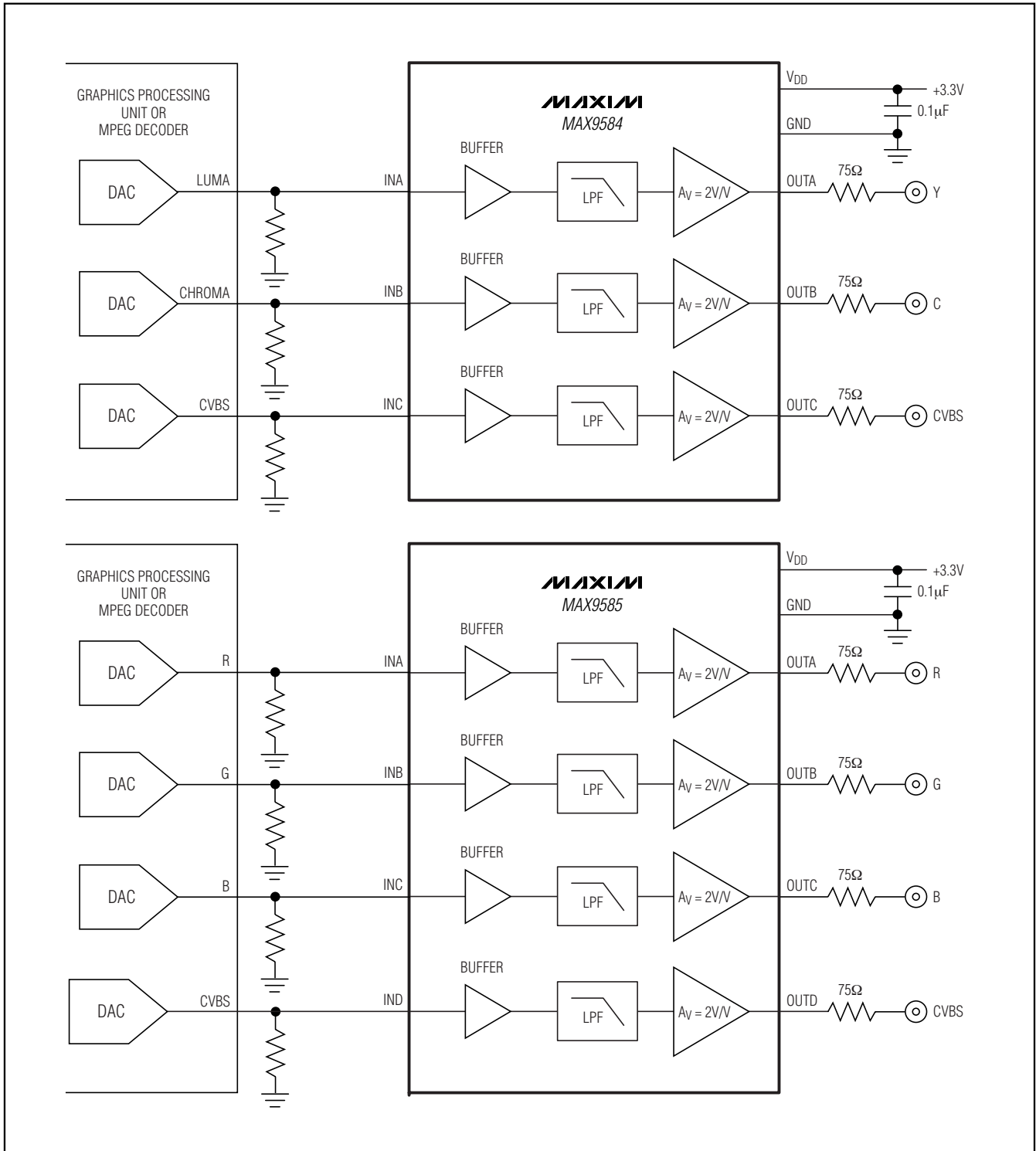

Dual, Triple, and Quad Standard-Definition Video Filter Amplifiers with DC-Coupled Input Buffers

Detailed Description

The MAX9583/MAX9584/MAX9585 filter and amplify the video DAC output in applications such as set-top boxes and televisions. These devices consist of input buffers, lowpass filters, and gain of 2V/V output amplifiers capable of driving a standard 150 Ω video load to ground.

Inputs

The video inputs should be directly connected to the output of the video current DAC. DC coupling ensures that the input signals are ground referenced so that the sync tip of composite or luma signals is within 50mV of ground and the blank level of the chroma signal is between 0.5V and 0.65V. Since the input buffers are identical, any standard-definition video signal can be applied to those inputs provided the signal is between ground and 1.05V when $V_{DD} = 2.7V$. For example, three composite video signals could be applied to INA, INB, and INC of the MAX9584. The RGB set or the YPbPr set can also be inputs to INA, INB, and INC of the MAX9584.

Video Filter

The filter passband ($\pm 1dB$) is typically 7MHz, which makes the device suitable for standard-definition video signals from all sources (e.g., broadcast and DVD). Broadcast video signals are channel limited: NTSC signals have 4.2MHz bandwidth and PAL signals have 5MHz bandwidth. Video signals from a DVD player, however, are not channel limited, so the bandwidth of DVD video signals can approach the Nyquist limit of 6.75MHz. (Recommendation ITU-R BT.601-5 specifies 13.5MHz as the sampling rate for standard-definition video). Therefore, the maximum bandwidth of the signal is 6.75MHz. To ease the filtering requirements, most modern video systems oversample by two times, clocking the video current DAC at 27MHz.

Outputs

The video output amplifiers can both source and sink load current, allowing output loads to be DC- or AC-coupled. The amplifier output stage needs approximately 300mV of headroom from either supply rail. The devices have an internal level-shift circuit that positions the sync tip at approximately 300mV at the output. The blank level of the chroma output is positioned at approximately 1.3V if the blank level of the chroma input signal is 0.5V. The blank level of the chroma output is positioned at approximately 1.5V if the blank level of the chroma input signal is 0.6V.

If the supply voltage is greater than 3.135V (5% below a 3.3V supply), each amplifier can drive two DC-coupled video loads to ground. If the supply is less than 3.135V, each amplifier can drive only one DC-coupled or AC-coupled video load.

Applications Information

Reducing Power Consumption in the Video DACs

The MAX9583/MAX9584/MAX9585 have high-impedance input buffers that work with source resistances as high as 300 Ω . To reduce power dissipation in the video DACs, the DAC output resistor can be scaled up in value. The reference resistor that sets the reference current inside the video DACs must also be similarly scaled up. For instance, if the output resistor is 37.5 Ω , the DAC must source 26.7mA when the output is 1V. If the output resistor is increased to 300 Ω , then the DAC only needs to source 3.33mA when the output is 1V.

There is parasitic capacitance from the DAC output to ground. That capacitance, in parallel with the DAC output resistor, forms a pole that can potentially roll off the frequency response of the video signal. For example, 300 Ω in parallel with 50pF create a pole at 10.6MHz. To minimize this capacitance, reduce the area of the signal trace attached to the DAC output as much as possible, and place the MAX9583/MAX9584/MAX9585 as close as possible to the video DAC outputs.

AC-Coupling the Outputs

The outputs can be AC-coupled since the output stage can source and sink current as shown in Figure 1. Coupling capacitors should be 220 μF or greater to keep the highpass filter, formed by the 150 Ω equivalent resistance of the video transmission line, to a corner frequency of 4.8Hz or below. The frame rate of PAL systems is 25Hz, and the frame rate of NTSC systems is 30Hz. The corner frequency should be well below the frame rate.

Power-Supply Bypassing and Ground

The MAX9583/MAX9584/MAX9585 operate from a single-supply voltage down to 2.7V, allowing for low-power operation. Bypass V_{DD} to GND with a 0.1 μF capacitor. Place all external components as close as possible to the device.

Dual, Triple, and Quad Standard-Definition Video Filter Amplifiers with DC-Coupled Input Buffers

MAX9583/MAX9584/MAX9585

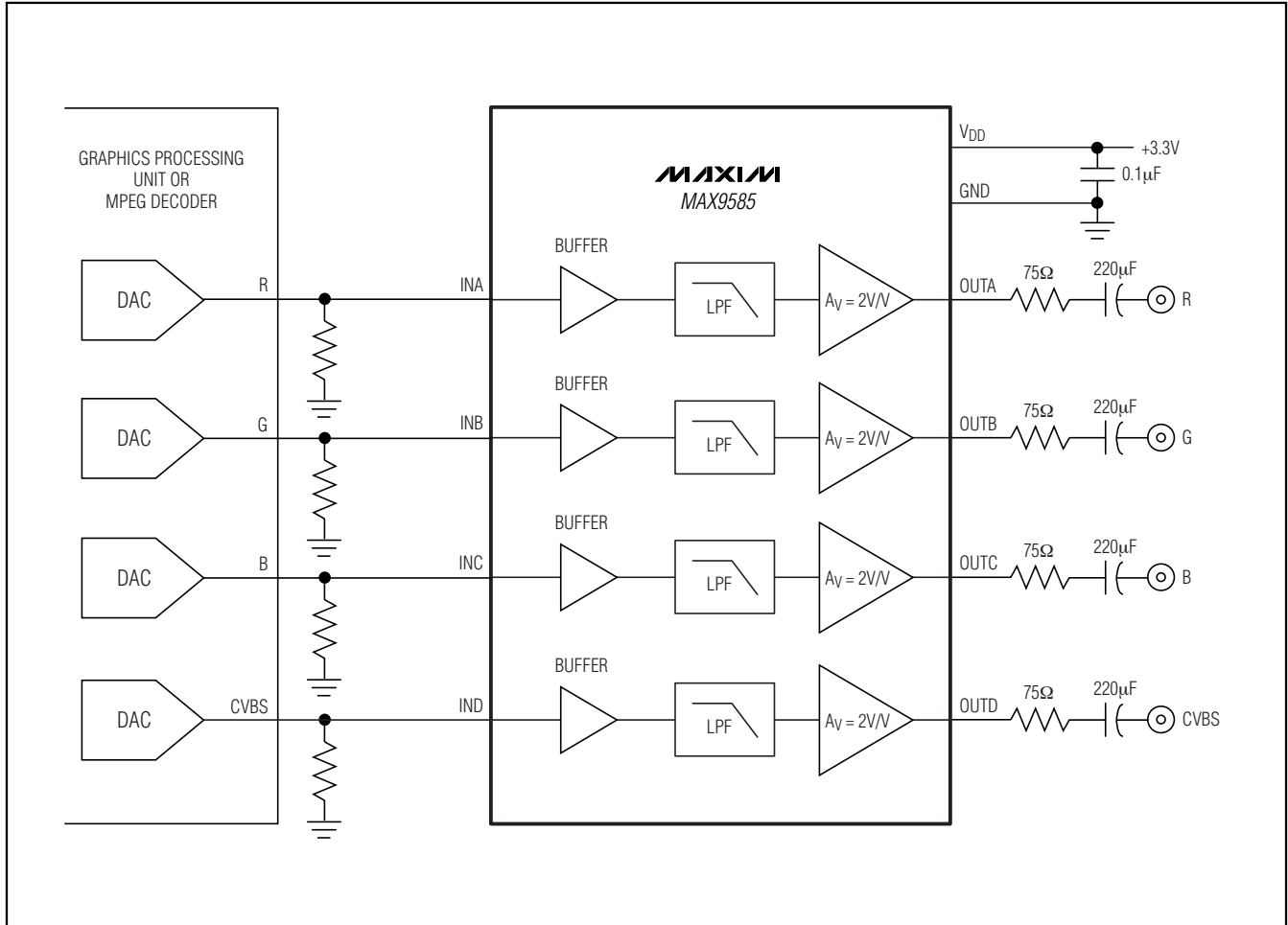
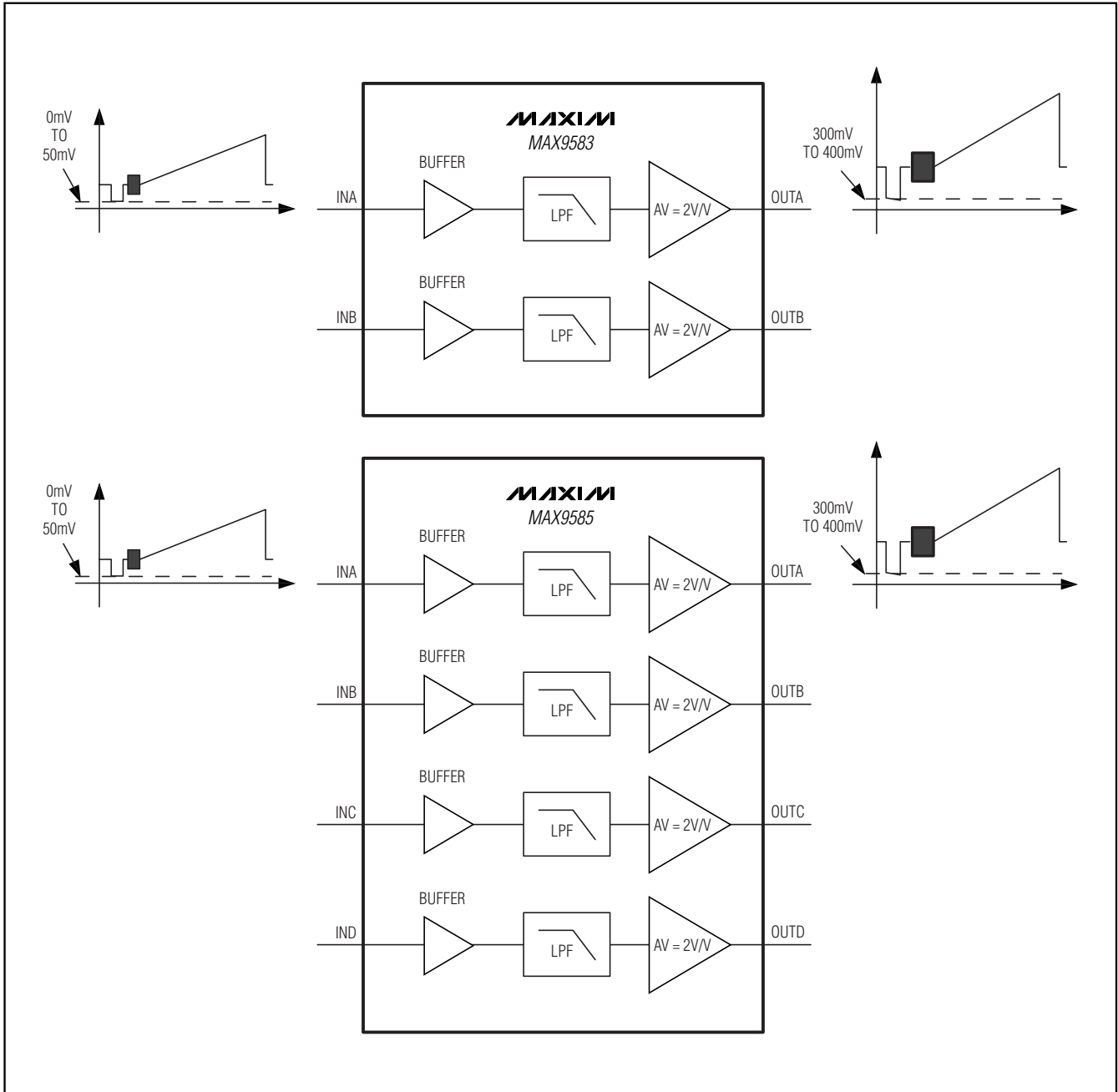

Figure 1. AC-Coupled Outputs

Dual, Triple, and Quad Standard-Definition Video Filter Amplifiers with DC-Coupled Input Buffers

Block Diagrams (continued)

MAX9583/MAX9584/MAX9585



Dual, Triple, and Quad Standard-Definition Video Filter Amplifiers with DC-Coupled Input Buffers

Pin Configurations

MAX9583/MAX9584/MAX9585

TOP VIEW

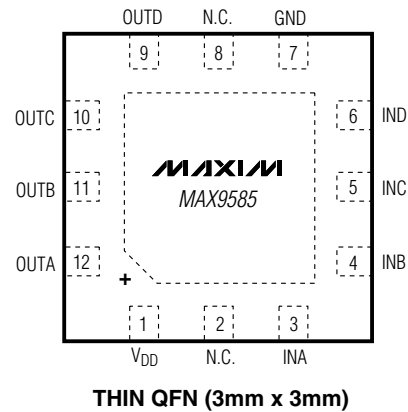
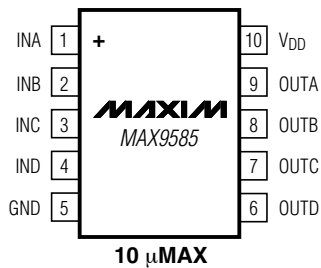
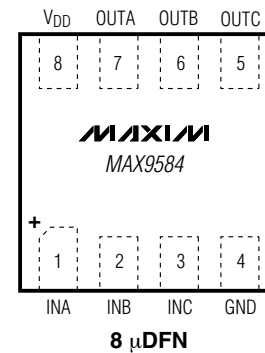
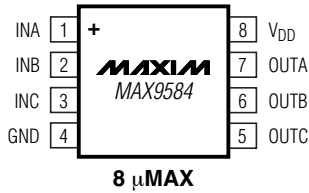
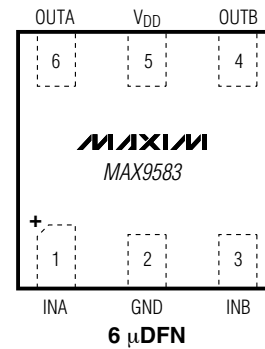
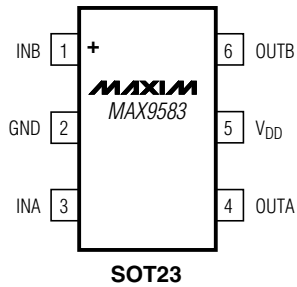

Dual, Triple, and Quad Standard-Definition Video Filter Amplifiers with DC-Coupled Input Buffers

Selector Guide

PART	PIN-PACKAGE	PACKAGE SIZE	CHANNELS	TOP MARK	PKG CODE
MAX9583AZT+	6 Thin SOT23-6	2.9mm x 1.6mm	2	AADJ	Z6+1
MAX9583ALT+*	6 μ DFN-6	2mm x 2mm	2	ACE	L622+1
MAX9584AUA+	8 μ MAX-8	3mm x 3mm	3	—	U8+1
MAX9584ALA+*	8 μ DFN-8	2mm x 2mm	3	ABV	L822+1
MAX9585AUB+	10 μ MAX-10	3mm x 3mm	4	—	U10+2
MAX9585ATC+*	12 TQFN-EP**	3mm x 3mm	4	ABG	T1233+4

Note: All devices are specified over the -40°C to +125°C operating temperature range.

+Denotes a lead-free package.

*Future product—contact factory for availability.

**EP = Exposed paddle.

Chip Information

PROCESS: BICMOS

MAX9583/MAX9584/MAX9585

Dual, Triple, and Quad Standard-Definition Video Filter Amplifiers with DC-Coupled Input Buffers

Package Information

(The package drawing(s) in this data sheet may not reflect the most current specifications. For the latest package outline information, go to www.maxim-ic.com/packages.)

MAX9583/MAX9584/MAX9585

6L THIN SOT23.EPS

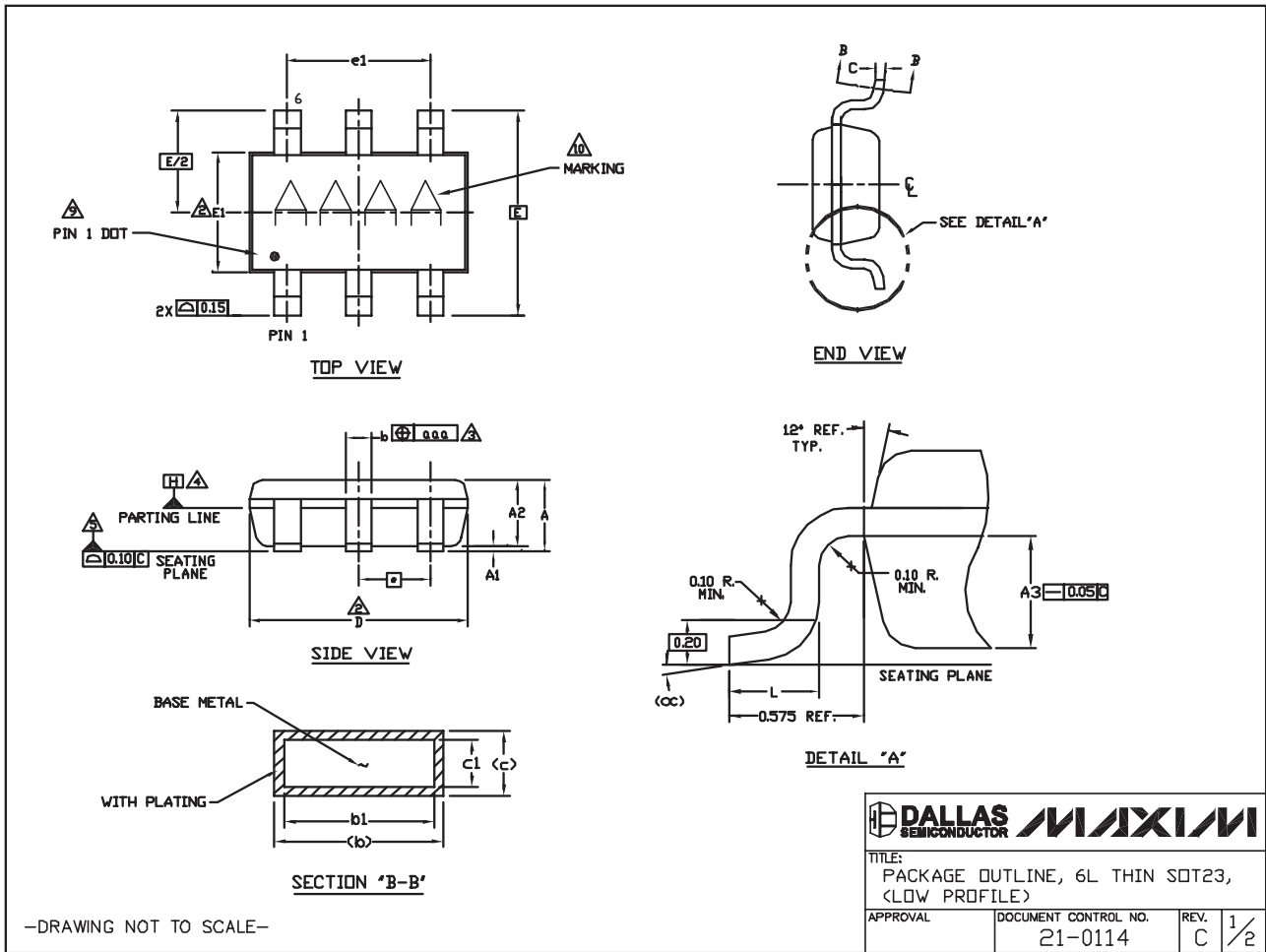

TITLE: PACKAGE OUTLINE, 6L THIN SOT23, (LOW PROFILE)		
APPROVAL	DOCUMENT CONTROL NO. 21-0114	REV. C 1/2

Dual, Triple, and Quad Standard-Definition Video Filter Amplifiers with DC-Coupled Input Buffers

Package Information (continued)

(The package drawing(s) in this data sheet may not reflect the most current specifications. For the latest package outline information, go to www.maxim-ic.com/packages.)

NOTES:

1. ALL DIMENSIONS ARE IN MILLIMETERS.

2. 'D' AND 'E1' ARE REFERENCE DATUM AND DO NOT INCLUDE MOLD FLASH OR PROTRUSIONS, AND ARE MEASURED AT THE BOTTOM PARTING LINE. MOLD FLASH OR PROTRUSION SHALL NOT EXCEED 0.15mm ON 'D' AND 0.25mm ON 'E' PER SIDE.

3. THE LEAD WIDTH DIMENSION DOES NOT INCLUDE DAMBAR PROTRUSION. ALLOWABLE DAMBAR PROTRUSION SHALL BE 0.07mm TOTAL IN EXCESS OF THE LEAD WIDTH DIMENSION AT MAXIMUM MATERIAL CONDITION.

4. DATUM PLANE 'H' LOCATED AT MOLD PARTING LINE AND COINCIDENT WITH LEAD, WHERE LEAD EXITS PLASTIC BODY AT THE BOTTOM OF PARTING LINE.

5. THE LEAD TIPS MUST LIE WITHIN A SPECIFIED TOLERANCE ZONE. THIS TOLERANCE ZONE IS DEFINED BY TWO PARALLEL LINES. ONE PLANE IS THE SEATING PLANE, DATUM [-C-] AND THE OTHER PLANE IS AT THE SPECIFIED DISTANCE FROM [-C-] IN THE DIRECTION INDICATED. FORMED LEADS SHALL BE PLANAR WITH RESPECT TO ONE ANOTHER WITH 0.10mm AT SEATING PLANE.

6. THIS PART IS COMPLIANT WITH JEDEC SPECIFICATION MO-193 EXCEPT FOR THE 'e' DIMENSION WHICH IS 0.95mm INSTEAD OF 1.00mm. THIS PART IS IN FULL COMPLIANCE TO EIAJ SPECIFICATION SC-74.

7. COPLANARITY APPLIES TO THE EXPOSED PAD AS WELL AS THE TERMINALS. COPLANARITY SHALL NOT EXCEED 0.08mm.

8. WARPAGE SHALL NOT EXCEED 0.10mm.

9. THE TERMINAL #1 IDENTIFIER AND TERMINAL NUMBERING CONVENTION SHALL CONFORM TO JEDEC 95-1 PP-012. DETAILS OF TERMINAL #1 IDENTIFIER ARE OPTIONAL. THE TERMINAL #1 IDENTIFIER MAY BE EITHER A MOLD OR MARKED FEATURE.

10. MARKING IS FOR PACKAGE ORIENTATION REFERENCE ONLY.

11. ALL DIMENSIONS APPLY TO BOTH LEADED (-) AND LEAD FREE (+) PACKAGE CODES.

SYMBOLS

	MIN	NOM	MAX
A	-	-	1.10
A1	0.00	0.075	0.10
A2	0.85	0.88	0.90
A3	0.50 BSC		
b	0.30	-	0.45
b1	0.25	0.35	0.40
c	0.15	-	0.20
c1	0.12	0.127	0.15
D	2.80	2.90	3.00
E	2.75 BSC		
E1	1.55	1.60	1.65
L	0.30	0.40	0.50
e1	1.90 BSC		
e	0.95 BSC		
OC	0°	4°	8°
aaa	0.20		
Pkg. codes: Z6-1J Z6-2			



TITLE:
PACKAGE OUTLINE, 6L THIN SOT23,
(LOW PROFILE)

APPROVAL	DOCUMENT CONTROL NO. 21-0114	REV. C	2/2
----------	---------------------------------	-----------	-----

-DRAWING NOT TO SCALE-

Dual, Triple, and Quad Standard-Definition Video Filter Amplifiers with DC-Coupled Input Buffers

Package Information (continued)

(The package drawing(s) in this data sheet may not reflect the most current specifications. For the latest package outline information, go to www.maxim-ic.com/packages.)

MAX9583/MAX9584/MAX9585

6, 8, 10L UDFN/EP

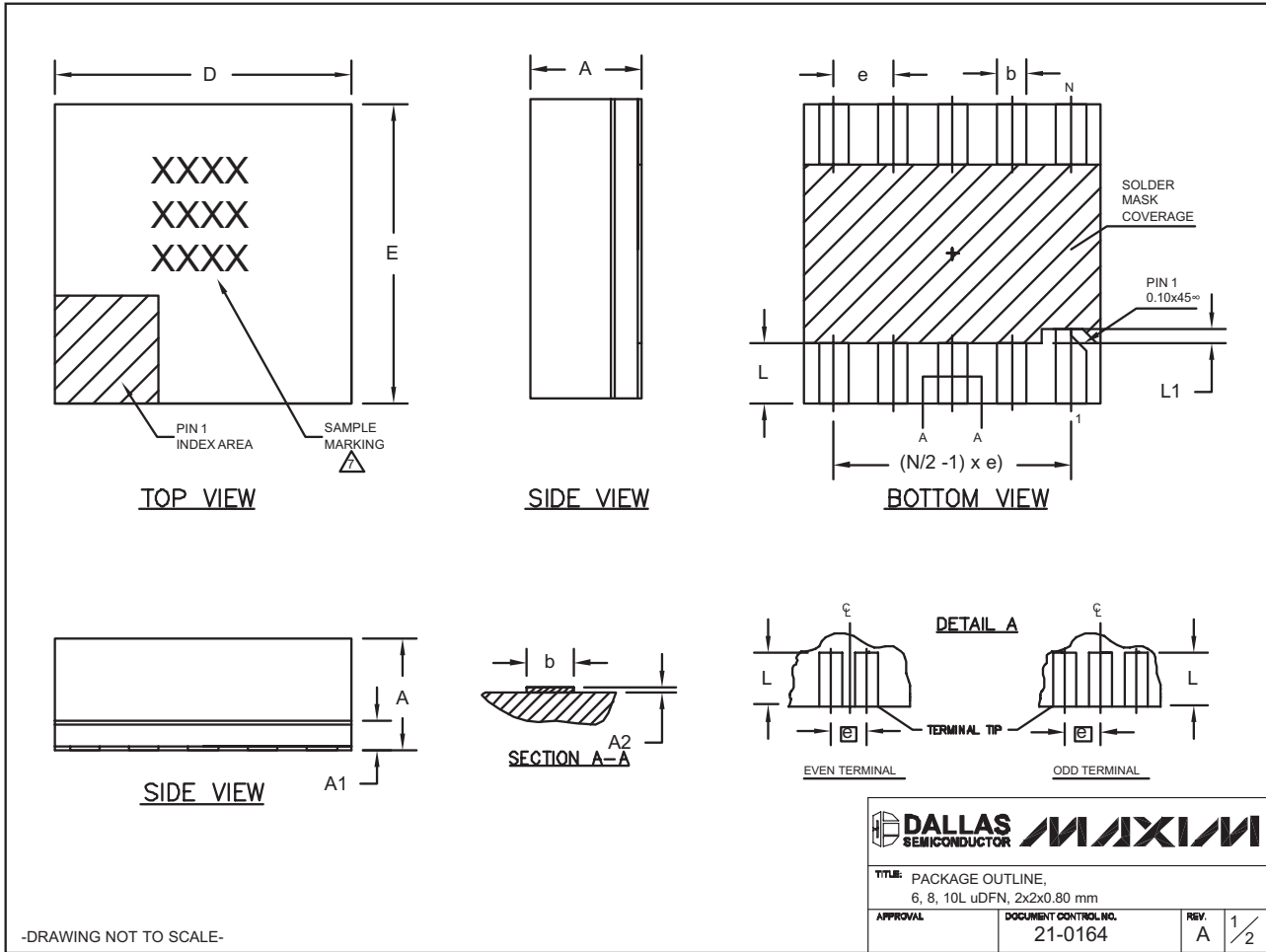

Dual, Triple, and Quad Standard-Definition Video Filter Amplifiers with DC-Coupled Input Buffers

MAX9583/MAX9584/MAX9585

Package Information (continued)

(The package drawing(s) in this data sheet may not reflect the most current specifications. For the latest package outline information, go to www.maxim-ic.com/packages.)

COMMON DIMENSIONS			
SYMBOL	MIN.	NOM.	MAX.
A	0.70	0.75	0.80
A1	0.15	0.20	0.25
A2	0.020	0.025	0.035
D	1.95	2.00	2.05
E	1.95	2.00	2.05
L	0.30	0.40	0.50
L1	0.10 REF.		

PACKAGE VARIATIONS				
PKG. CODE	N	e	b	(N/2 -1) x e
L622-1	6	0.65 BSC	0.30±0.05	1.30 REF.
L822-1	8	0.50 BSC	0.25±0.05	1.50 REF.
L1022-1	10	0.40 BSC	0.20±0.03	1.60 REF.

NOTES:

- ALL DIMENSIONS ARE IN mm. ANGLES IN DEGREES.
- COPLANARITY SHALL NOT EXCEED 0.08mm.
- WARPAGE SHALL NOT EXCEED 0.10mm.
- PACKAGE LENGTH/PACKAGE WIDTH ARE CONSIDERED AS SPECIAL CHARACTERISTIC(S).
- "N" IS THE TOTAL NUMBER OF LEADS.
- NUMBER OF LEADS SHOWN ARE FOR REFERENCE ONLY.
-  MARKING IS FOR PACKAGE ORIENTATION REFERENCE ONLY.

-DRAWING NOT TO SCALE-

DALLAS SEMICONDUCTOR		MAXIM	
TITLE: PACKAGE OUTLINE, 6, 8, 10L uDFN, 2x2x0.80 mm			
APPROVAL	DOCUMENT CONTROL NO.	REV.	2/2
	21-0164	A	

Dual, Triple, and Quad Standard-Definition Video Filter Amplifiers with DC-Coupled Input Buffers

Package Information (continued)

(The package drawing(s) in this data sheet may not reflect the most current specifications. For the latest package outline information, go to www.maxim-ic.com/packages.)

MAX9583/MAX9584/MAX9585

8LUMAXD.EPS

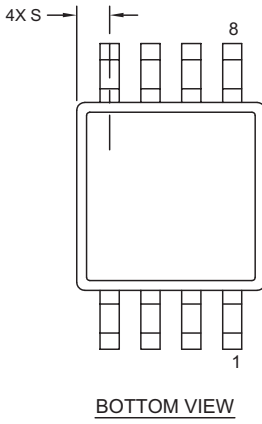
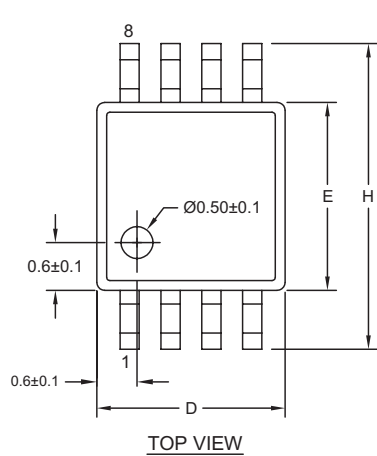

DIM	INCHES		MILLIMETERS	
	MIN	MAX	MIN	MAX
A	-	0.043	-	1.10
A1	0.002	0.006	0.05	0.15
A2	0.030	0.037	0.75	0.95
b	0.010	0.014	0.25	0.36
c	0.005	0.007	0.13	0.18
D	0.116	0.120	2.95	3.05
e	0.0256 BSC		0.65 BSC	
E	0.116	0.120	2.95	3.05
H	0.188	0.198	4.78	5.03
L	0.016	0.026	0.41	0.66
α	0°	6°	0°	6°
S	0.0207 BSC		0.5250 BSC	

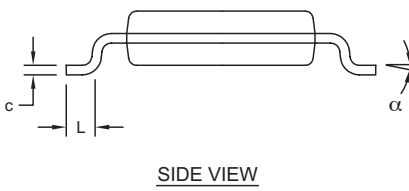
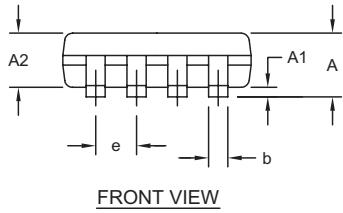

- NOTES:
1. D&E DO NOT INCLUDE MOLD FLASH.
 2. MOLD FLASH OR PROTRUSIONS NOT TO EXCEED 0.15MM (.006").
 3. CONTROLLING DIMENSION: MILLIMETERS.
 4. MEETS JEDEC MO-187C-AA.

DALLAS SEMICONDUCTOR **MAXIM**

PROPRIETARY INFORMATION

TITLE:
PACKAGE OUTLINE, 8L uMAX/uSOP

APPROVAL	DOCUMENT CONTROL NO. 21-0036	REV. J	1/1
----------	---------------------------------	--------	-----

Dual, Triple, and Quad Standard-Definition Video Filter Amplifiers with DC-Coupled Input Buffers

Package Information (continued)

(The package drawing(s) in this data sheet may not reflect the most current specifications. For the latest package outline information, go to www.maxim-ic.com/packages.)

10LUMAX.EPS

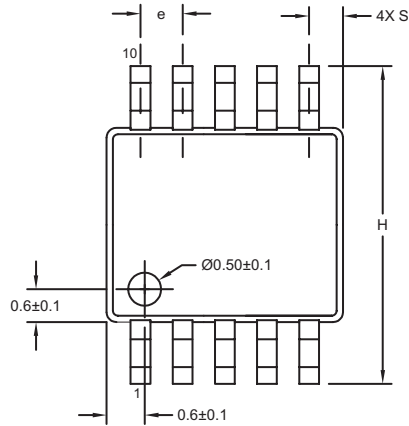

TOP VIEW

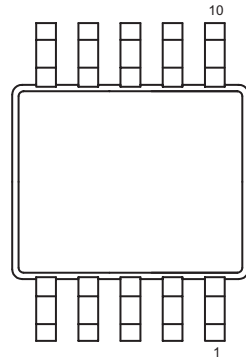

BOTTOM VIEW

DIM	INCHES		MILLIMETERS	
	MIN	MAX	MIN	MAX
A	-	0.043	-	1.10
A1	0.002	0.006	0.05	0.15
A2	0.030	0.037	0.75	0.95
D1	0.116	0.120	2.95	3.05
D2	0.114	0.118	2.89	3.00
E1	0.116	0.120	2.95	3.05
E2	0.114	0.118	2.89	3.00
H	0.187	0.199	4.75	5.05
L	0.0157	0.0275	0.40	0.70
L1	0.037 REF		0.940 REF	
b	0.007	0.0106	0.177	0.270
e	0.0197 BSC		0.500 BSC	
c	0.0035	0.0078	0.090	0.200
S	0.0196 REF		0.498 REF	
α	0°	6°	0°	6°

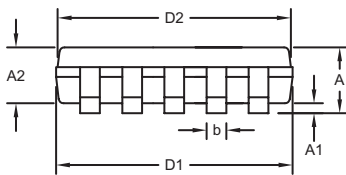

FRONT VIEW

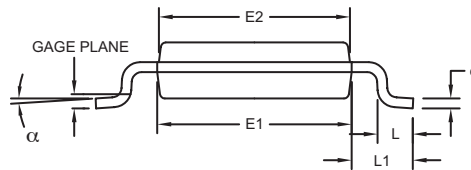

SIDE VIEW

NOTES:

1. D&E DO NOT INCLUDE MOLD FLASH.
2. MOLD FLASH OR PROTRUSIONS NOT TO EXCEED 0.15mm (.006").
3. CONTROLLING DIMENSION: MILLIMETERS.
4. MEETS JEDEC MO-187C-BA.

<small>PROPRIETARY INFORMATION</small>	
<small>TITLE:</small> PACKAGE OUTLINE, 10L uMAX/uSOP	
<small>APPROVAL</small>	<small>DOCUMENT CONTROL NO.</small> 21-0061
<small>REV.</small> I	<small>1/1</small>

Dual, Triple, and Quad Standard-Definition Video Filter Amplifiers with DC-Coupled Input Buffers

Package Information (continued)

(The package drawing(s) in this data sheet may not reflect the most current specifications. For the latest package outline information, go to www.maxim-ic.com/packages.)

MAX9583/MAX9584/MAX9585

12x16L QFN THIN:EPS

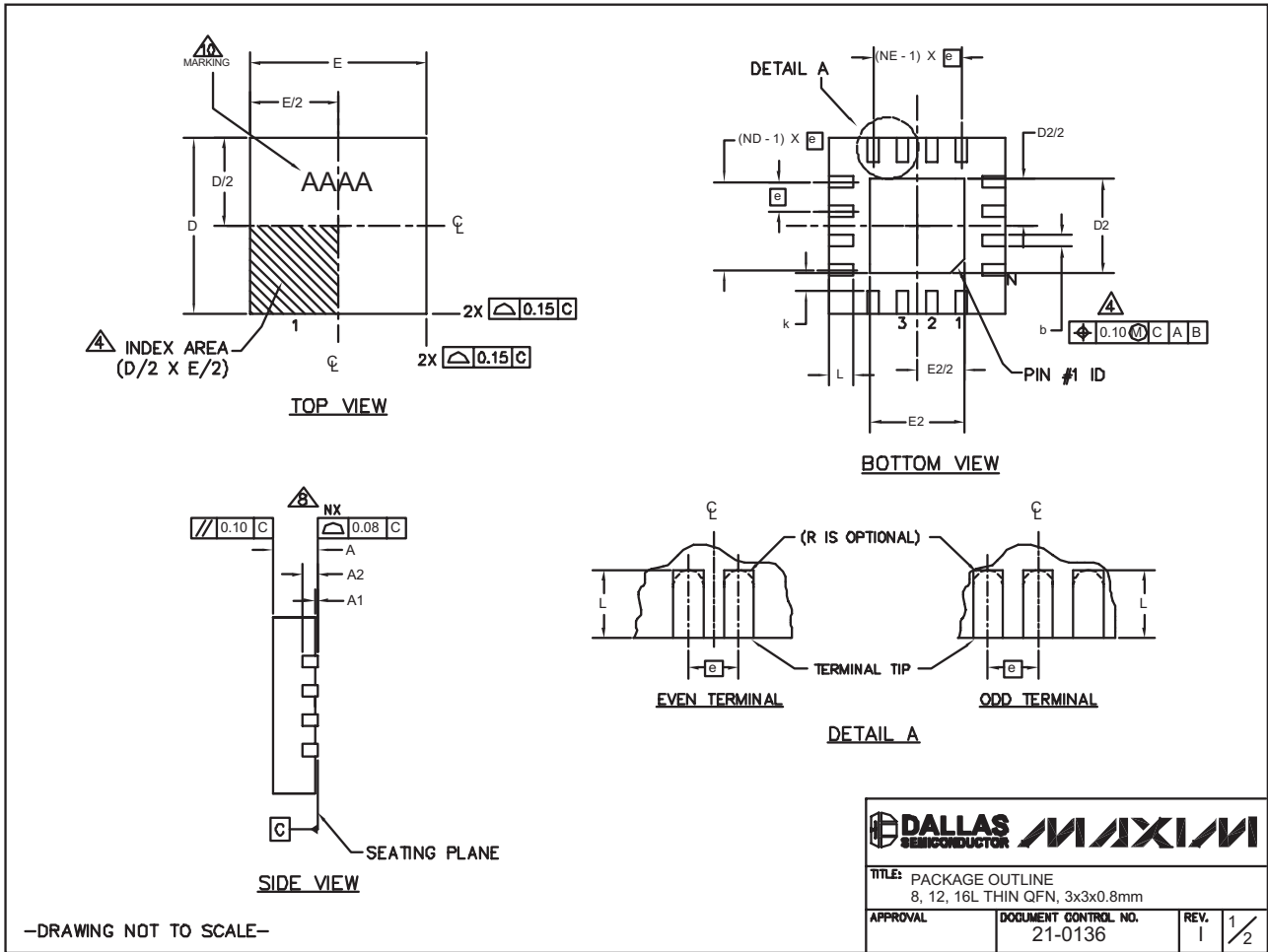

Dual, Triple, and Quad Standard-Definition Video Filter Amplifiers with DC-Coupled Input Buffers

Package Information (continued)

(The package drawing(s) in this data sheet may not reflect the most current specifications. For the latest package outline information, go to www.maxim-ic.com/packages.)

PKG	8L 3x3			12L 3x3			16L 3x3		
REF.	MIN.	NOM.	MAX.	MIN.	NOM.	MAX.	MIN.	NOM.	MAX.
A	0.70	0.75	0.80	0.70	0.75	0.80	0.70	0.75	0.80
b	0.25	0.30	0.35	0.20	0.25	0.30	0.20	0.25	0.30
D	2.90	3.00	3.10	2.90	3.00	3.10	2.90	3.00	3.10
E	2.90	3.00	3.10	2.90	3.00	3.10	2.90	3.00	3.10
e	0.65 BSC.			0.50 BSC.			0.50 BSC.		
L	0.35	0.55	0.75	0.45	0.55	0.65	0.30	0.40	0.50
N	8			12			16		
ND	2			3			4		
NE	2			3			4		
A1	0	0.02	0.05	0	0.02	0.05	0	0.02	0.05
A2	0.20 REF			0.20 REF			0.20 REF		
k	0.25	-	-	0.25	-	-	0.25	-	-

EXPOSED PAD VARIATIONS								
PKG. CODES	D2			E2			PIN ID	JEDEC
	MIN.	NOM.	MAX.	MIN.	NOM.	MAX.		
TQ833-1	0.25	0.70	1.25	0.25	0.70	1.25	0.35 x 45°	WEEC
T1233-1	0.95	1.10	1.25	0.95	1.10	1.25	0.35 x 45°	WEED-1
T1233-3	0.95	1.10	1.25	0.95	1.10	1.25	0.35 x 45°	WEED-1
T1233-4	0.95	1.10	1.25	0.95	1.10	1.25	0.35 x 45°	WEED-1
T1633-2	0.95	1.10	1.25	0.95	1.10	1.25	0.35 x 45°	WEED-2
T1633F-3	0.65	0.80	0.95	0.65	0.80	0.95	0.225 x 45°	WEED-2
T1633FH-3	0.65	0.80	0.95	0.65	0.80	0.95	0.225 x 45°	WEED-2
T1633-4	0.95	1.10	1.25	0.95	1.10	1.25	0.35 x 45°	WEED-2
T1633-5	0.95	1.10	1.25	0.95	1.10	1.25	0.35 x 45°	WEED-2

NOTES:

- DIMENSIONING & TOLERANCING CONFORM TO ASME Y14.5M-1994.
- ALL DIMENSIONS ARE IN MILLIMETERS. ANGLES ARE IN DEGREES.
- N IS THE TOTAL NUMBER OF TERMINALS.
- THE TERMINAL #1 IDENTIFIER AND TERMINAL NUMBERING CONVENTION SHALL CONFORM TO JESD 95-1 SPP-012. DETAILS OF TERMINAL #1 IDENTIFIER ARE OPTIONAL, BUT MUST BE LOCATED WITHIN THE ZONE INDICATED. THE TERMINAL #1 IDENTIFIER MAY BE EITHER A MOLD OR MARKED FEATURE.
- DIMENSION b APPLIES TO METALLIZED TERMINAL AND IS MEASURED BETWEEN 0.20 mm AND 0.25 mm FROM TERMINAL TIP.
- ND AND NE REFER TO THE NUMBER OF TERMINALS ON EACH D AND E SIDE RESPECTIVELY.
- DEPOPULATION IS POSSIBLE IN A SYMMETRICAL FASHION.
- COPLANARITY APPLIES TO THE EXPOSED HEAT SINK SLUG AS WELL AS THE TERMINALS.
- DRAWING CONFORMS TO JEDEC MO220 REVISION C.
- MARKING IS FOR PACKAGE ORIENTATION REFERENCE ONLY.
- NUMBER OF LEADS SHOWN ARE FOR REFERENCE ONLY.
- WARPAGE NOT TO EXCEED 0.10mm.

—DRAWING NOT TO SCALE—

DALLAS SEMICONDUCTOR			MAXIM		
TITLE: PACKAGE OUTLINE					
8, 12, 16L THIN QFN, 3x3x0.8mm					
APPROVAL	DOCUMENT CONTROL NO.	REV.			
	21-0136	1	2/2		

Revision History

Pages changed at Rev 1: 1, 2, 20

Maxim cannot assume responsibility for use of any circuitry other than circuitry entirely embodied in a Maxim product. No circuit patent licenses are implied. Maxim reserves the right to change the circuitry and specifications without notice at any time.

20 **Maxim Integrated Products, 120 San Gabriel Drive, Sunnyvale, CA 94086 408-737-7600**

© 2007 Maxim Integrated Products

MAXIM is a registered trademark of Maxim Integrated Products, Inc.