

# Type CD4 High-Frequency, Mica Capacitors

## Ultra-High-Frequency Capacitor for CATV and RF Applications 0.1" Lead Spacing



Nearly the textbook ideal capacitor for high-frequency applications, Type CD4 is rock stable over its full temperature and voltage range. Higher self-resonant frequency and lower equivalent series inductance makes CD4 even better than CD17 and CD18 for high-frequency applications. 0.1" lead spacing means CD4 can replace ceramic capacitors on printed circuit boards.

### Highlights

- Higher self-resonant frequency and lower equivalent series inductance than CD17 and CD18
- Low impedance to beyond 1 GHz
- Replaces other 0.1" lead-spacing capacitors
- Cool operation—Typical  $Q_s > 2000$
- Shockproof and delamination free
- Near zero capacitance change with frequency and temperature
- Meets Requirements of MIL-PRF-39001
- 100,000 V/ $\mu$ s dV/dt capability minimum
- Zero capacitance change with voltage

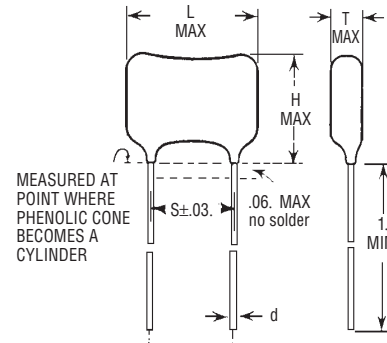

### Specifications

<b>Voltage Range:</b>	100 Vdc to 500 Vdc
<b>Capacitance Range:</b>	1 pF to 1,500 pF
<b>Capacitance Tolerance:</b>	$\pm 1/2$ pF (D), $\pm 1$ pF (C), $\pm 1/2\%$ (E), $\pm 1\%$ (F), $\pm 1\%$ (F), $\pm 2\%$ (G), $\pm 5\%$ (J)
<b>Temperature Range:</b>	-55 °C to +125 °C
<b>Reliability:</b>	Established reliability to .01%/1,000 hours failure rate

### Ratings

(pF)	Catalog Part Number	L (mm)	H (mm)	T (mm)	S (mm)	d (mm)
<b>100 Vdc</b>						
910	CD4FA911J03	.340 (8.6)	.310 (7.9)	.160 (4.1)	.100 (2.5)	.020 (.5)
1000	CD4FA102J03	.340 (8.6)	.310 (7.9)	.160 (4.1)	.100 (2.5)	.020 (.5)
1100	CD4FA112J03	.340 (8.6)	.310 (7.9)	.160 (4.1)	.100 (2.5)	.020 (.5)
1200	CD4FA122J03	.340 (8.6)	.310 (7.9)	.170 (4.3)	.100 (2.5)	.020 (.5)
1500	CD4FA152J03	.340 (8.6)	.310 (7.9)	.180 (4.6)	.100 (2.5)	.020 (.5)
<b>300 Vdc</b>						
560	CD4FC561J03	.340 (8.6)	.310 (7.9)	.160 (4.1)	.100 (2.5)	.020 (.5)
620	CD4FC621J03	.340 (8.6)	.310 (7.9)	.160 (4.1)	.100 (2.5)	.020 (.5)
680	CD4FC681J03	.340 (8.6)	.310 (7.9)	.160 (4.1)	.100 (2.5)	.020 (.5)
750	CD4FC751J03	.340 (8.6)	.310 (7.9)	.160 (4.1)	.100 (2.5)	.020 (.5)
820	CD4FC821J03	.340 (8.6)	.310 (7.9)	.160 (4.1)	.100 (2.5)	.020 (.5)
<b>500 Vdc</b>						
1	CD4CD010D03	.290 (7.4)	.220 (5.6)	.110 (2.8)	.100 (2.5)	.020 (.5)
2	CD4CD020D03	.290 (7.4)	.220 (5.6)	.110 (2.8)	.100 (2.5)	.020 (.5)
3	CD4CD030D03	.290 (7.4)	.220 (5.6)	.110 (2.8)	.100 (2.5)	.020 (.5)
4	CD4CD040D03	.290 (7.4)	.220 (5.6)	.110 (2.8)	.100 (2.5)	.020 (.5)
5	CD4CD050D03	.290 (7.4)	.220 (5.6)	.110 (2.8)	.100 (2.5)	.020 (.5)
6	CD4CD060D03	.290 (7.4)	.220 (5.6)	.110 (2.8)	.100 (2.5)	.020 (.5)
7	CD4CD070D03	.290 (7.4)	.220 (5.6)	.110 (2.8)	.100 (2.5)	.020 (.5)
8	CD4CD080D03	.290 (7.4)	.220 (5.6)	.110 (2.8)	.100 (2.5)	.020 (.5)
10	CD4CD100J03	.290 (7.4)	.220 (5.6)	.110 (2.8)	.100 (2.5)	.020 (.5)
12	CD4CD120J03	.290 (7.4)	.220 (5.6)	.110 (2.8)	.100 (2.5)	.020 (.5)
15	CD4CD150J03	.290 (7.4)	.220 (5.6)	.110 (2.8)	.100 (2.5)	.020 (.5)
18	CD4CD180J03	.290 (7.4)	.220 (5.6)	.110 (2.8)	.100 (2.5)	.020 (.5)
20	CD4ED200J03	.290 (7.4)	.220 (5.6)	.110 (2.8)	.100 (2.5)	.020 (.5)
22	CD4ED220J03	.290 (7.4)	.220 (5.6)	.110 (2.8)	.100 (2.5)	.020 (.5)
24	CD4ED240J03	.290 (7.4)	.220 (5.6)	.110 (2.8)	.100 (2.5)	.020 (.5)
27	CD4ED270J03	.290 (7.4)	.220 (5.6)	.110 (2.8)	.100 (2.5)	.020 (.5)
30	CD4ED300J03	.290 (7.4)	.220 (5.6)	.110 (2.8)	.100 (2.5)	.020 (.5)
33	CD4ED330J03	.290 (7.4)	.220 (5.6)	.110 (2.8)	.100 (2.5)	.020 (.5)
36	CD4ED360J03	.290 (7.4)	.220 (5.6)	.110 (2.8)	.100 (2.5)	.020 (.5)

(pF)	Catalog Part Number	L (mm)	H (mm)	T (mm)	S (mm)	d (mm)
39	CD4ED390J03	.290 (7.4)	.220 (5.6)	.110 (2.8)	.100 (2.5)	.020 (.5)
43	CD4ED430J03	.290 (7.4)	.220 (5.6)	.110 (2.8)	.100 (2.5)	.020 (.5)
47	CD4ED470J03	.290 (7.4)	.220 (5.6)	.110 (2.8)	.100 (2.5)	.020 (.5)
50	CD4ED500J03	.290 (7.4)	.220 (5.6)	.110 (2.8)	.100 (2.5)	.020 (.5)
51	CD4ED510J03	.290 (7.4)	.220 (5.6)	.110 (2.8)	.100 (2.5)	.020 (.5)
56	CD4ED560J03	.290 (7.4)	.220 (5.6)	.110 (2.8)	.100 (2.5)	.020 (.5)
62	CD4ED620J03	.290 (7.4)	.220 (5.6)	.110 (2.8)	.100 (2.5)	.020 (.5)
68	CD4ED680J03	.290 (7.4)	.220 (5.6)	.110 (2.8)	.100 (2.5)	.020 (.5)
75	CD4ED750J03	.290 (7.4)	.220 (5.8)	.110 (2.8)	.100 (2.5)	.020 (.5)
82	CD4ED820J03	.290 (7.4)	.220 (5.8)	.110 (2.8)	.100 (2.5)	.020 (.5)
91	CD4FD910J03	.290 (7.4)	.220 (5.8)	.110 (2.8)	.100 (2.5)	.020 (.5)
100	CD4FD101J03	.290 (7.4)	.240 (6.1)	.110 (2.8)	.100 (2.5)	.020 (.5)
110	CD4FD111J03	.290 (7.4)	.240 (6.1)	.110 (2.8)	.100 (2.5)	.020 (.5)
120	CD4FD121J03	.290 (7.4)	.240 (6.1)	.110 (2.8)	.100 (2.5)	.020 (.5)
130	CD4FD131J03	.340 (8.6)	.310 (7.9)	.160 (4.1)	.100 (2.5)	.020 (.5)
150	CD4FD151J03	.340 (8.6)	.310 (7.9)	.160 (4.1)	.100 (2.5)	.020 (.5)
160	CD4FD161J03	.340 (8.6)	.310 (7.9)	.160 (4.1)	.100 (2.5)	.020 (.5)
180	CD4FD181J03	.340 (8.6)	.310 (7.9)	.160 (4.1)	.100 (2.5)	.020 (.5)
200	CD4FD201J03	.340 (8.6)	.310 (7.9)	.160 (4.1)	.100 (2.5)	.020 (.5)
220	CD4FD221J03	.340 (8.6)	.310 (7.9)	.160 (4.1)	.100 (2.5)	.020 (.5)
240	CD4FD241J03	.340 (8.6)	.310 (7.9)	.160 (4.1)	.100 (2.5)	.020 (.5)
250	CD4FD251J03	.340 (8.6)	.310 (7.9)	.160 (4.1)	.100 (2.5)	.020 (.5)
270	CD4FD271J03	.340 (8.6)	.310 (7.9)	.160 (4.1)	.100 (2.5)	.020 (.5)
300	CD4FD301J03	.340 (8.6)	.310 (7.9)	.160 (4.1)	.100 (2.5)	.020 (.5)
330	CD4FD331J03	.340 (8.6)	.310 (7.9)	.160 (4.1)	.100 (2.5)	.020 (.5)
360	CD4FD361J03	.340 (8.6)	.310 (7.9)	.160 (4.1)	.100 (2.5)	.020 (.5)
390	CD4FD391J03	.340 (8.6)	.310 (7.9)	.160 (4.1)	.100 (2.5)	.020 (.5)
430	CD4FD431J03	.340 (8.6)	.310 (7.9)	.160 (4.1)	.100 (2.5)	.020 (.5)
470	CD4FD471J03	.340 (8.6)	.310 (7.9)	.160 (4.1)	.100 (2.5)	.020 (.5)
500	CD4FD501J03	.340 (8.6)	.310 (7.9)	.160 (4.1)	.100 (2.5)	.020 (.5)
510	CD4FD511J03	.340 (8.6)	.310 (7.9)	.160 (4.1)	.100 (2.5)	.020 (.5)

# Type CD4 High-Frequency, Mica Capacitors

## Typical Performance Curves

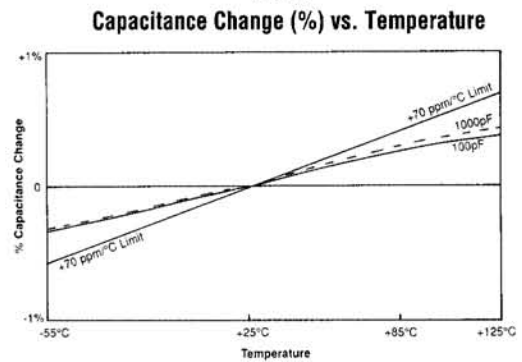
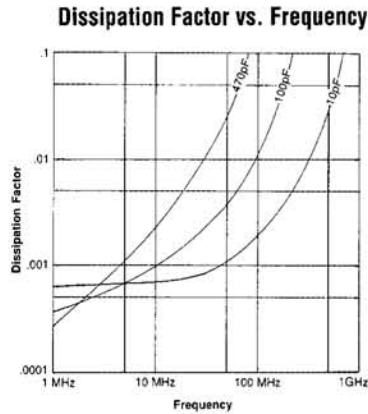
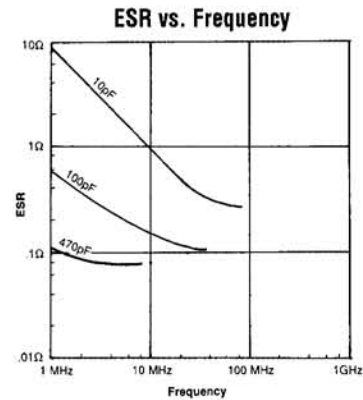
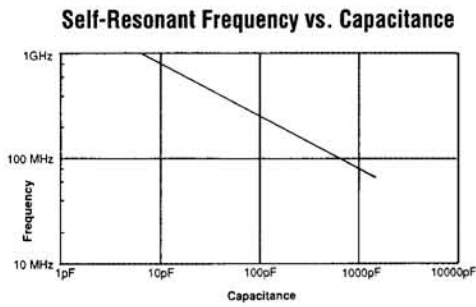

## Insertion Loss

Over the frequency range of 100 MHz to 1 GHz the insertion loss in a balanced 50  $\Omega$  or 75  $\Omega$  system is flat  $\pm 0.2$  dB. A typical test setup is below.

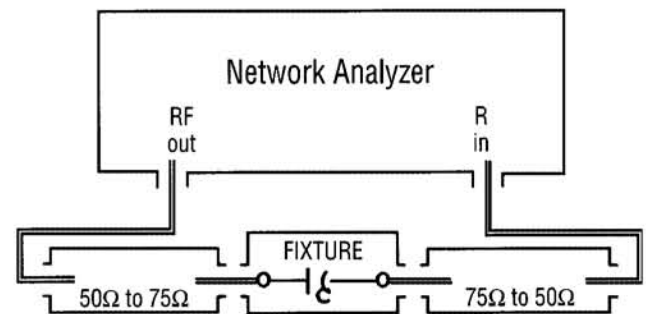
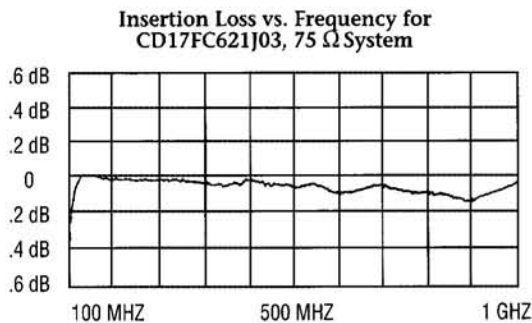

## Choosing CD4, CD16, CDV16, CD18 or CDV18

While insertion loss is flat within  $\pm 0.2$  dB through 1 GHz, you may be able to avoid the small notch by changing the capacitor type to fit your capacitance. See table at right.

TYPE	Flat to Above 1 GHz
CD17	470 pF max
CD4	620 pF max
CD16	870 pF
CDV16	870 pF
CD18	660 pF max
CDV18	1000 pF max