



5V, Step-Down, Current-Mode PWM DC-DC Converters

General Description

The MAX730A/MAX738A/MAX744A are 5V-output CMOS, step-down switching regulators. The MAX738A/MAX744A accept inputs from 6V to 16V and deliver 750mA. The MAX744A guarantees 500mA load capability for inputs above 6V and has tighter oscillator frequency limits for low-noise (radio) applications. The MAX730A accepts inputs between 5.2V and 11V and delivers 450mA for inputs above 6V. Typical efficiencies are 85% to 96%. Quiescent supply current is 1.7mA and only 6 μ A in shutdown.

Pulse-width modulation (PWM) current-mode control provides precise output regulation and excellent transient responses. Output voltage accuracy is guaranteed to be $\pm 5\%$ over line, load, and temperature variations. Fixed-frequency switching allows easy filtering of output ripple and noise, as well as the use of small external components. These regulators require only a single inductor value to work in most applications, so no inductor design is necessary.

The MAX730A/MAX738A/MAX744A also feature cycle-by-cycle current limiting, overcurrent limiting, undervoltage lockout, and programmable soft-start protection.

Applications

Portable Instruments
Cellular Phones and Radios
Personal Communicators
Distributed Power Systems
Computer Peripherals

Typical Operating Circuit

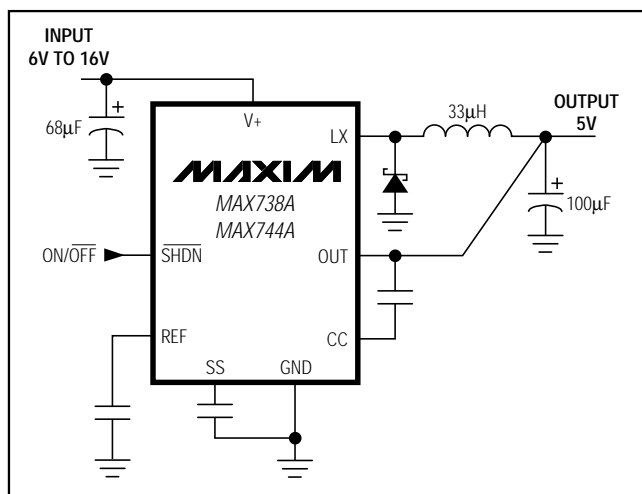

Features

- ◆ 750mA Load Currents (MAX738A/MAX744A)
- ◆ High-Frequency, Current-Mode PWM
- ◆ 159kHz to 212.5kHz Guaranteed Oscillator Frequency Limits (MAX744A)
- ◆ 85% to 96% Efficiencies
- ◆ 1.7mA Quiescent Current
- ◆ 6 μ A Shutdown Supply Current
- ◆ Single Preselected Inductor Value, No Component Design Required
- ◆ Overcurrent, Soft-Start, and Undervoltage Lockout Protection
- ◆ Cycle-by-Cycle Current Limiting
- ◆ 8-Pin DIP/SO Packages (MAX730A)

Ordering Information

PART	TEMP. RANGE	PIN-PACKAGE
MAX730ACPA	0°C to +70°C	8 Plastic DIP
MAX730ACSA	0°C to +70°C	8 SO
MAX730AC/D	0°C to +70°C	Dice*
MAX730AEP A	-40°C to +85°C	8 Plastic DIP
MAX730AES A	-40°C to +85°C	8 SO
MAX730AMJ A	-55°C to +125°C	8 CERDIP

Ordering Information continued at end of data sheet.

*Contact factory for dice specifications.

Pin Configurations

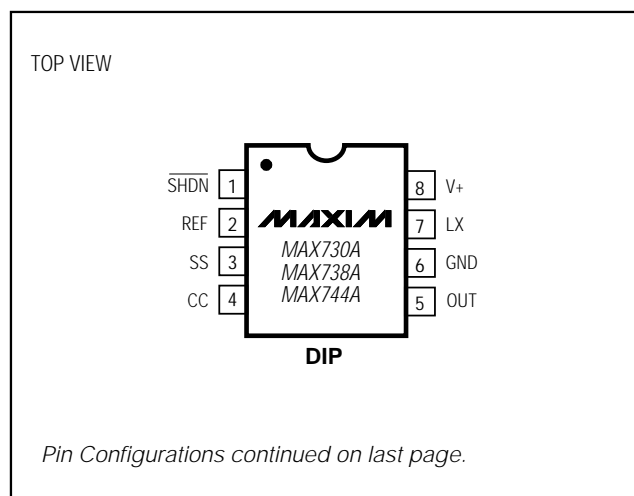

Maxim Integrated Products 1

For free samples & the latest literature: <http://www.maxim-ic.com>, or phone 1-800-998-8800

MAX730A/MAX738A/MAX744A

5V, Step-Down, Current-Mode PWM DC-DC Converters

ABSOLUTE MAXIMUM RATINGS

Pin Voltages	
V+ (MAX730A)	+12V, -0.3V
V+ (MAX738A/MAX744A)	+18V, -0.3V
LX (MAX730A)	(V+ - 12V) to (V+ + 0.3V)
LX (MAX738A/MAX744A)	(V+ - 21V) to (V+ + 0.3V)
OUT	±25V
SS, CC, SHDN	-0.3V to (V+ + 0.3V)
Peak Switch Current (I _{LX})	2A
Reference Current (I _{REF})	2.5mA
Continuous Power Dissipation (T _A = +70°C)	
8-Pin Plastic DIP (derate 9.09mW/°C above +70°C)	727mW
8-Pin SO (derate 5.88mW/°C above +70°C)	471mW
16-Pin Wide SO (derate 9.52mW/°C above +70°C)	762mW
8-Pin CERDIP (derate 8.00mW/°C above +70°C)	640mW

Operating Temperature Ranges:	
MAX7_ _AC_ _	0°C to +70°C
MAX7_ _AE_ _	-40°C to +85°C
MAX7_ _AMJA	-55°C to +125°C
Junction Temperatures:	
MAX7_ _AC_ _/AE_ _	+150°C
MAX7_ _AMJA	+175°C
Storage Temperature Range	
	-65°C to +160°C
Lead Temperature (soldering, 10sec)	
	+300°C

Stresses beyond those listed under "Absolute Maximum Ratings" may cause permanent damage to the device. These are stress ratings only, and functional operation of the device at these or any other conditions beyond those indicated in the operational sections of the specifications is not implied. Exposure to absolute maximum rating conditions for extended periods may affect device reliability.

ELECTRICAL CHARACTERISTICS

(Circuit of Figure 3, V+ = 9V for the MAX730A, V+ = 12V for the MAX738A/MAX744A, I_{LOAD} = 0mA, T_A = T_{MIN} to T_{MAX}, unless otherwise noted.)

PARAMETER	CONDITIONS		MAX730A			MAX738A			MAX744A			UNITS
			MIN	TYP	MAX	MIN	TYP	MAX	MIN	TYP	MAX	
Output Voltage	V+ = 6.0V to 11.0V	0mA < I _{LOAD} < 450mA, MAX730AC	4.75	5.00	5.25						V	
		0mA < I _{LOAD} < 450mA, MAX730AE										
		0mA < I _{LOAD} < 300mA, MAX730AM										
	V+ = 6.0V to 16.0V	0mA < I _{LOAD} < 450mA, MAX738AC/AE	4.75	5.00	5.25	4.75	5.00	5.25	4.75	5.00		5.25
		0mA < I _{LOAD} < 350mA, MAX738AM										
		0mA < I _{LOAD} < 500mA, MAX744AC/AE										
		0mA < I _{LOAD} < 375mA, MAX744AM										
	V+ = 10.2V to 16.0V, 0mA < I _{LOAD} < 750mA	4.75	5.00	5.25								
V+ = 9.0V to 16.0V	0mA < I _{LOAD} < 750mA, MAX744AC/AE	4.75	5.00	5.25				4.75	5.00	5.25		
	0mA < I _{LOAD} < 600mA, MAX744AM											
Input Voltage Range		5.2	11.0		6.0	16.0		6.0	16.0		V	
Line Regulation	V+ = 5.2V to 11.0V	0.15									%V	
	V+ = 6.0V to 16.0V				0.15			0.15				

5V, Step-Down, Current-Mode PWM DC-DC Converters

MAX730A/MAX738A/MAX744A

ELECTRICAL CHARACTERISTICS (continued)

(Circuit of Figure 3, $V_+ = 9V$ for the MAX730A, $V_+ = 12V$ for the MAX738A/MAX744A, $I_{LOAD} = 0mA$, $T_A = T_{MIN}$ to T_{MAX} , unless otherwise noted.)

PARAMETER	CONDITIONS		MAX730A			MAX738A			MAX744A			UNITS	
			MIN	TYP	MAX	MIN	TYP	MAX	MIN	TYP	MAX		
Load Regulation	$I_{LOAD} = 0mA$ to $300mA$		0.0005									%mA	
	$I_{LOAD} = 0mA$ to $750mA$					0.0005			0.0005				
Efficiency	$V_+ = 9.0V$, $I_{LOAD} = 300mA$		92			90			90			%	
	$V_+ = 12V$, $I_{LOAD} = 750mA$					87			87				
Supply Current (includes switch current)			1.7	3.0		1.7	3.0		1.7	3.0		mA	
	$V_+ = 6.0V$ to $9.0V$	MAX744AC/AE							1.2	2.5			
		MAX744AM							3.0				
	$V_+ = 9.0V$ to $12.0V$	MAX744AC/AE							3.0				
		MAX744AM							3.5				
	$V_+ = 12.0V$ to $16.0V$	MAX744AC							4.0				
		MAX744AE							4.3				
		MAX744AM							4.5				
Standby Current	$\overline{SHDN} = 0V$ (Note 1)		6.0	100.0		6.0	100.0		6.0	100.0	μA		
Shutdown Input Threshold	V_{IH}		2.0			2.0			2.0			V	
	V_{IL}		0.25			0.25			0.25				
Shutdown Input Leakage Current			1.0			1.0			1.0			μA	
Short-Circuit Current			1.5			1.5			1.5			A	
Undervoltage Lockout	V_+ rising		4.7	5.2		5.7	6.0		5.7	6.0	V		
	V_+ falling								5.0	5.7			
LX On Resistance	$I_{LX} = 500mA$		0.5			0.5			0.5			Ω	
LX Leakage Current	$V_+ = 12V$, $LX = 0V$		1.0			1.0			1.0			μA	
Reference Voltage	$V_+ = 12V$, $T_A = +25^\circ C$		1.15	1.23	1.30	1.15	1.23	1.30	1.15	1.23	1.30	V	
Reference Drift			50			50			50			ppm/ $^\circ C$	
Oscillator Frequency			130	170	210	130	160	190				kHz	
	$V_+ = 6.0V$ to $16.0V$	MAX744AC/AE							159.0	185.0	212.5		
MAX744AM								159.0	216.5				
Compensation Pin Impedance			7500			7500			7500			Ω	

Note 1: The standby current typically settles to $25\mu A$ (over temperature) within 2 seconds; however, to decrease test time, the part is guaranteed at a $100\mu A$ maximum value.

5V, Step-Down, Current-Mode PWM DC-DC Converters

Typical Operating Characteristics

(Circuit of Figure 3, $T_A = +25^\circ\text{C}$, unless otherwise noted.)

MAX730A
EFFICIENCY vs. OUTPUT CURRENT

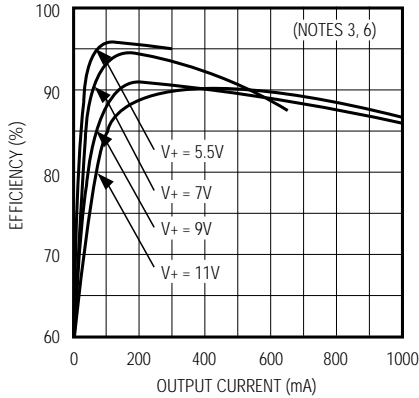

MAX738A
EFFICIENCY vs. OUTPUT CURRENT

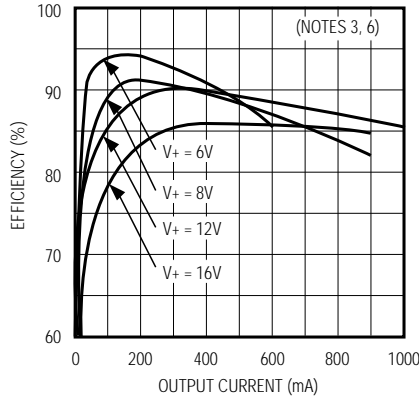

MAX744A
EFFICIENCY vs. OUTPUT CURRENT

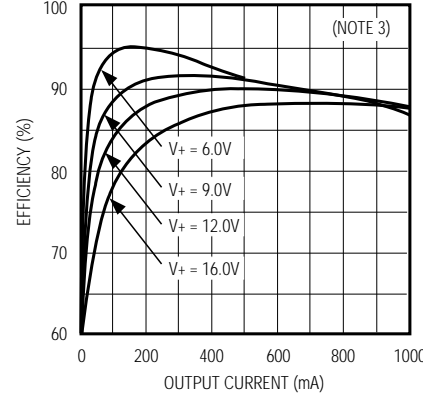

MAXIMUM OUTPUT CURRENT vs. SUPPLY VOLTAGE

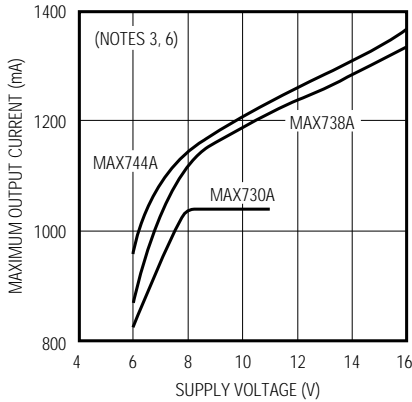

MAXIMUM OUTPUT CURRENT vs. SUPPLY VOLTAGE, NO R1

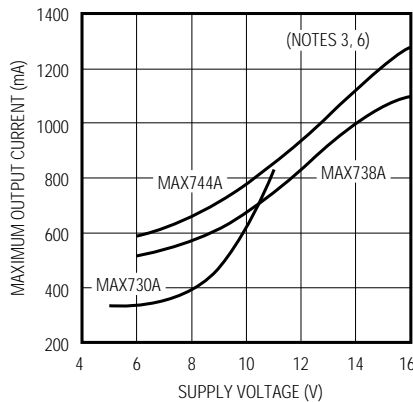

QUIESCENT SUPPLY CURRENT vs. TEMPERATURE

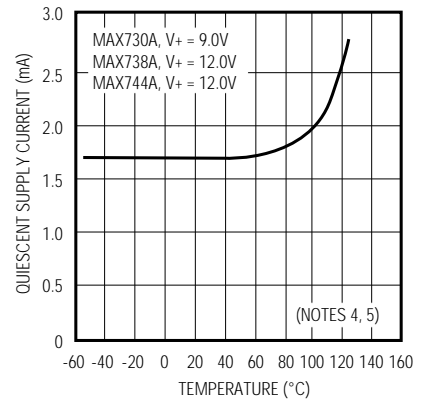

MAX738A/MAX744A
QUIESCENT SUPPLY CURRENT vs. SUPPLY VOLTAGE

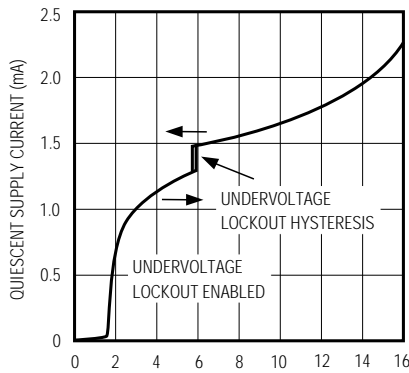

MAX738A/MAX744A
PEAK INDUCTOR CURRENT vs. OUTPUT CURRENT

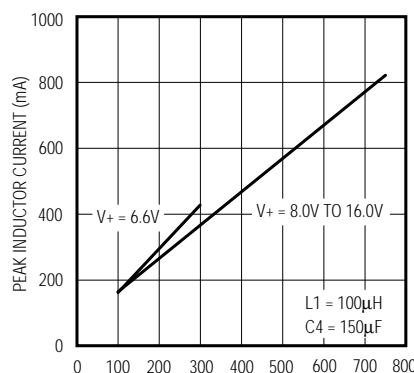

STANDBY SUPPLY CURRENT vs. TEMPERATURE

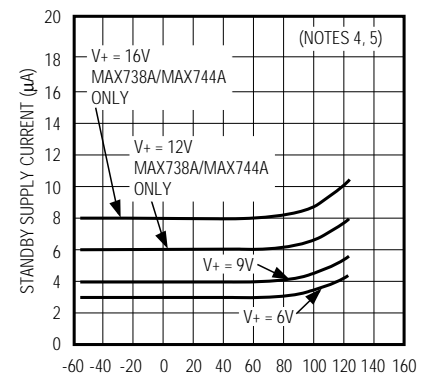

5V, Step-Down, Current-Mode PWM DC-DC Converters

Typical Operating Characteristics (continued)

(Circuit of Figure 3, $T_A = +25^\circ\text{C}$, unless otherwise noted.)

MAX730A/MAX738A/MAX744A

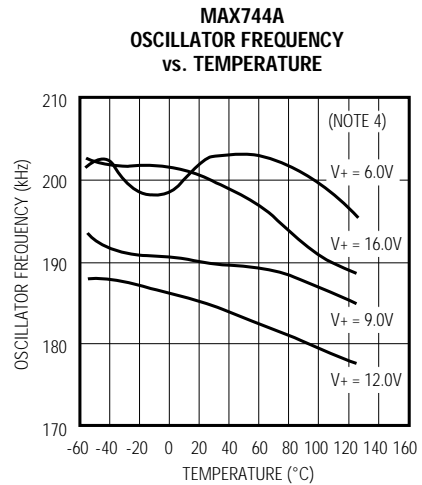
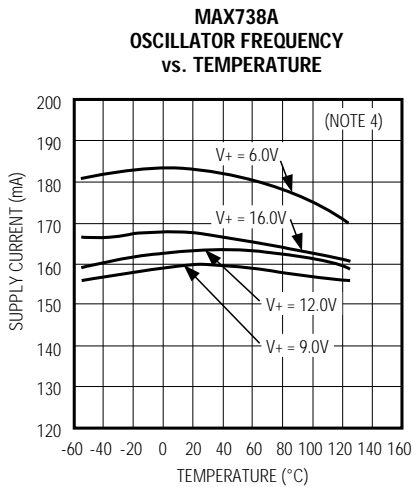
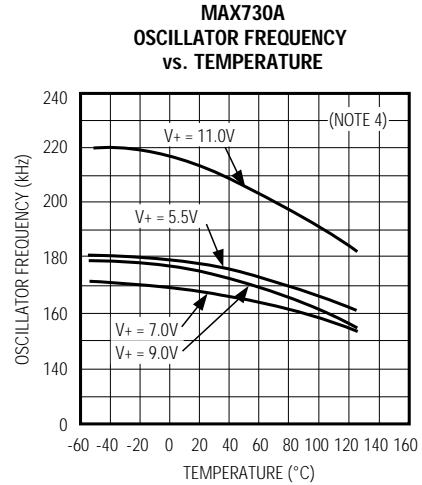
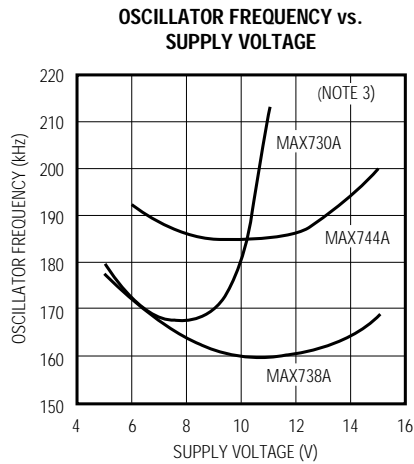

Note 3: Commercial temperature range external component values in Table 3.

Note 4: Wide temperature range external component values in Table 3.

Note 5: Standby and shutdown current includes all external component leakage currents. Capacitor leakage currents dominate at $T_A > +85^\circ\text{C}$. Sanyo OS-CON capacitors were used.

Note 6: Operation beyond the specifications listed in the electrical characteristics may exceed the power dissipation ratings of the device.

5V, Step-Down, Current-Mode PWM DC-DC Converters

MAX730A/MAX738A/MAX744A

Typical Operating Characteristics (continued)

(Circuit of Figure 3, $T_A = +25^\circ\text{C}$, unless otherwise noted.)

**MAX738A/MAX744A
SWITCHING WAVEFORMS,
CONTINUOUS CONDITION**

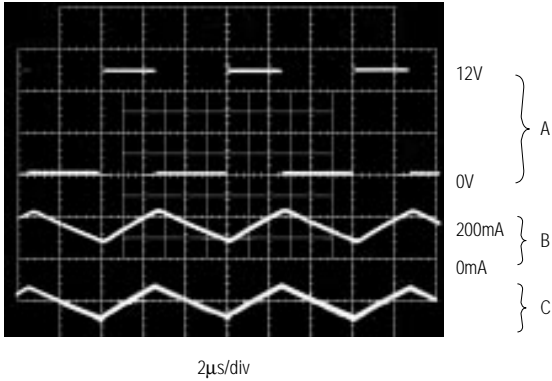

A: SWITCH VOLTAGE (LX PIN), 5V/div, 0V TO +12V
B: INDUCTOR CURRENT, 200mA/div
C: OUTPUT VOLTAGE RIPPLE, 50mV/div, AC-COUPLED

$C_{OUT} = 390\mu\text{F}$,
 $V_+ = 12\text{V}$, $I_{OUT} = 150\mu\text{A}$

**MAX738A/MAX744A
SWITCHING WAVEFORMS,
DISCONTINUOUS CONDITION**

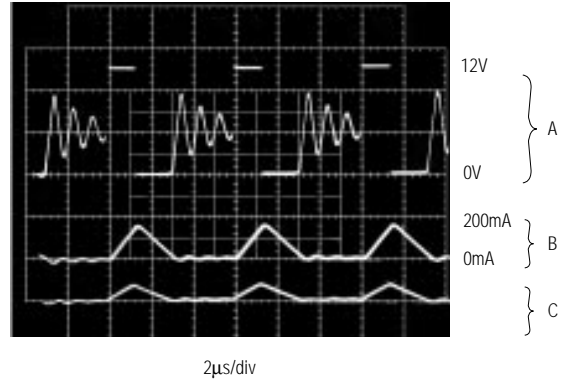

A: SWITCH VOLTAGE (LX PIN), 5V/div, 0V TO +12V
B: INDUCTOR CURRENT, 200mA/div
C: OUTPUT VOLTAGE RIPPLE, 50mV/div, AC-COUPLED

$C_{OUT} = 390\mu\text{F}$,
 $V_+ = 12\text{V}$, $I_{OUT} = 150\mu\text{A}$

MAX730A LINE-TRANSIENT RESPONSE

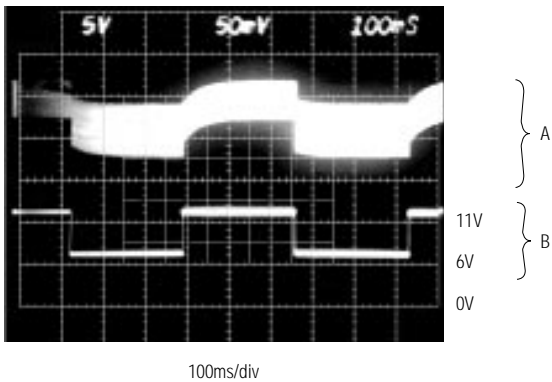

A: V_{OUT} , 50mV/div, DC-COUPLED
B: V_+ , 5V/div, 6.0V TO 11.0V

$I_{OUT} = 300\text{mA}$

MAX738A/MAX744A LINE-TRANSIENT RESPONSE

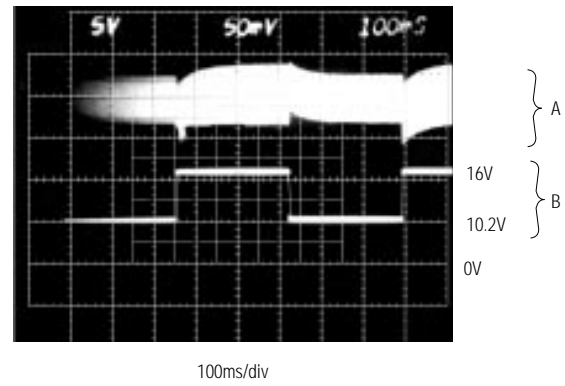

A: V_{OUT} , 50mV/div, DC-COUPLED
B: V_+ , 5V/div, 10.2V TO 16.0V

$I_{OUT} = 750\text{mA}$

5V, Step-Down, Current-Mode PWM DC-DC Converters

Typical Operating Characteristics (continued)

(Circuit of Figure 3, $T_A = +25^\circ\text{C}$, unless otherwise noted.)

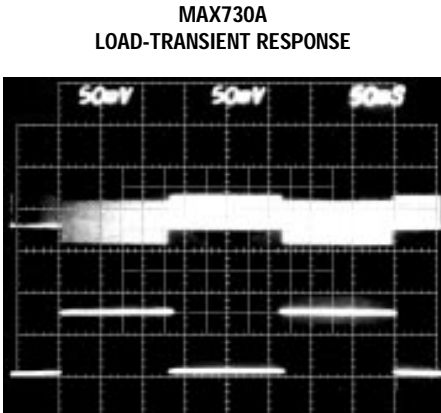

50ms/div

A: V_{OUT} , 50mV/div, DC-COUPLED
B: I_{OUT} , 200mA/div, 20mA TO 300mA

$V_+ = 9\text{V}$

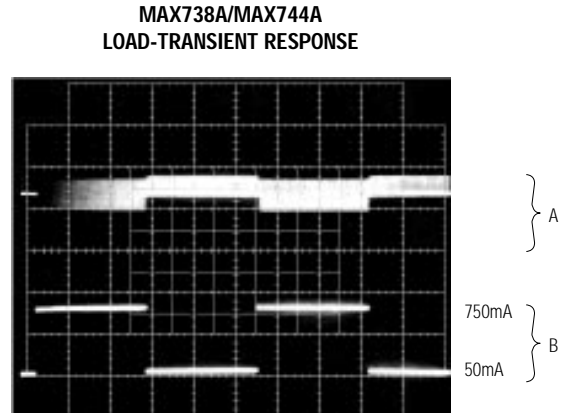

50ms/div

A: V_{OUT} , 50mV/div, DC-COUPLED
B: I_{OUT} , 500mA/div, 50mA TO 750mA

$V_+ = 12\text{V}$

MAX730A/MAX738A/MAX744A

Pin Description

PIN		NAME	FUNCTION
8-PIN DIP/SO	16-PIN WIDE SO		
1	2	$\overline{\text{SHDN}}$	Shutdown—active low. Ground to power-down chip, tie to V_+ for normal operation. Output voltage falls to 0V when $\overline{\text{SHDN}}$ is low.
2	3	REF	Reference-Voltage Output (+1.23V) supplies up to 100 μA for extended loads. Bypass to GND with a capacitor that does not exceed 0.047 μF .
3	7	SS	Soft-Start. Capacitor between SS and GND provides soft-start and short-circuit protection. 510k Ω resistor from SS to $\overline{\text{SHDN}}$ provides current boost.
4	8	CC	Compensation Capacitor Input externally compensates the outer feedback loop. Connect to OUT with a 330pF capacitor.
5	9	OUT	Output Voltage Sense Input provides regulation feedback sensing. Connect to +5V output.
6	10, 11	GND	Ground pins are internally connected. Connect both pins to ground.
7	12, 13, 14	LX	Drain of internal P-channel power MOSFET.
8	1, 15, 16	V_+	Supply-Voltage Input. Bypass to GND with 1 μF ceramic and large-value electrolytic capacitors in parallel. The 1 μF capacitor must be as close to V_+ and GND pins as possible.
	4, 5, 6	N.C.	No Connect—no internal connections to these pins.

5V, Step-Down, Current-Mode PWM DC-DC Converters

Detailed Description

The MAX730A/MAX738A/MAX744A switch-mode regulators use a current-mode pulse-width-modulation (PWM) control system coupled with a simple step-down (buck) regulator topography. They convert an unregulated DC voltage from 5.2V to 11V for the MAX730A, and from 6V to 16V for the MAX738A/MAX744A. The current-mode PWM architecture provides cycle-by-cycle current limiting, improved load-transient response characteristics, and simpler outer-loop design.

The controller consists of two feedback loops: an inner (current) loop that monitors the switch current via the current-sense resistor and amplifier, and an outer (voltage) loop that monitors the output voltage through the error amplifier (Figure 1). The inner loop performs cycle-by-cycle current limiting, truncating the power transistor on-time when the switch current reaches a predetermined threshold. This threshold is determined by the outer loop. For example, a sagging output voltage produces an error signal that raises the threshold, allowing the circuit to store and transfer more energy during each cycle.

Programmable Soft-Start

Figures 1 and 2 show a capacitor and a resistor connected to the soft-start (SS) pin to ensure an orderly power-up. Typical values are 0.1 μ F and 510k Ω . SS controls both the SS timing and the maximum output current that can be delivered while maintaining regulation.

The charging capacitor slowly raises the clamp on the error-amplifier output voltage, limiting surge currents at power-up by slowly increasing the cycle-by-cycle current-limit threshold. The 510k Ω resistor sets the SS clamp at a value high enough to maintain regulation, even at currents exceeding 1A. This resistor is not necessary for lower-current loads. Refer to the Maximum Output Current vs. Supply Voltage graph in the *Typical Operating Characteristics*. Table 1 lists timing characteristics for selected capacitor values and circuit conditions.

The overcurrent comparator trips when the load exceeds approximately 1.5A. An SS cycle begins when either an undervoltage or overcurrent fault condition triggers an internal transistor to momentarily discharge the SS capacitor to ground. An SS cycle also begins at power-up and when coming out of shutdown mode.

Overcurrent Limiting

The overcurrent comparator triggers when the load current exceeds approximately 1.5A. On each clock cycle, the output FET turns on and attempts to deliver current until cycle-by-cycle or overcurrent limits are exceeded. Note that the SS capacitor must be greater than 0.01 μ F

for overcurrent protection to function properly. A typical value is 0.1 μ F.

Undervoltage Lockout

The MAX738A/MAX744A's undervoltage-lockout feature monitors the supply voltage at V+, and allows operation to start when V+ rises above 5.7V (6V guaranteed). When V+ falls, operation continues until the supply voltage falls below 5.45V (see the MAX738A/MAX744A Quiescent Supply Current vs. Supply Voltage graph in the *Typical Operating Characteristics*). The MAX730A is similar, starting operation at V+ > 4.7V and continuing to operate down to 4.45V. When an undervoltage condition is detected, control logic turns off the output power FET and discharges the SS capacitor to ground. This prevents partial turn-on of the power MOSFET and avoids excessive power dissipation. The control logic holds the output power FET off until the supply voltage rises above approximately 4.7V (MAX730A) or 5.7V (MAX738A/MAX744A), at which time an SS cycle begins.

Shutdown Mode

The MAX730A/MAX738A/MAX744A are shut down by keeping $\overline{\text{SHDN}}$ at ground. In shutdown mode, the output drops to 0V and the output power FET is held in an off state. The internal reference also turns off, which causes the SS capacitor to discharge. Typical standby current in shutdown mode is 6 μ A. The actual design limit for standby current is much less than the 100 μ A specified in the *Electrical Characteristics* (see Standby Current vs. Temperature in the *Typical Operating Characteristics*). However, testing to tighter limits is prohibitive because the current takes several seconds to settle to a final value. For normal operation, connect $\overline{\text{SHDN}}$ to V+. Note that coming out of shutdown mode initiates an SS cycle.

Continuous-/Discontinuous-Conduction Modes

The input voltage, output voltage, load current, and inductor value determine whether the IC operates in continuous or discontinuous mode. As the inductor value or load current decreases, or the input voltage increases, the MAX730A/MAX738A/MAX744A tend to operate in discontinuous-conduction mode (DCM). In DCM, the inductor current slope is steep enough so it decays to zero before the end of the transistor off-time. In continuous-conduction mode (CCM), the inductor current never decays to zero, which is typically more efficient than DCM. CCM allows the MAX730A/MAX738A/MAX744A to deliver maximum load current, and is also slightly less noisy than DCM, because the peak-to-average inductor current ratio is reduced.

5V, Step-Down, Current-Mode PWM DC-DC Converters

MAX730A/MAX738A/MAX744A

Table 1. Typical Soft-Start Times

MAX730A CIRCUIT CONDITIONS				SOFT-START TIME (ms) vs. C1 (μF)			
R1 (kΩ)	V+ (V)	I _{OUT} (mA)	C4 (μF)	C1 = 0.01	C1 = 0.047	C1 = 0.1	C1 = 0.47
510	6	0	100	2	6	11	28
510	9	0	100	1	4	6	15
510	11	0	100	1	2	4	11
510	9	150	100	1	4	8	21
510	9	300	100	1	5	9	27
510	9	150	390	3	6	9	23
510	9	150	680	4	6	9	24
None	6	0	100	16	34	51	125
None	9	0	100	10	22	34	82
None	11	0	100	8	18	28	66
None	9	150	100	34	134	270	1263
None	9	150	390	39	147	280	1275
None	9	150	680	40	152	285	1280

MAX738A/MAX744A CIRCUIT CONDITIONS				SOFT-START TIME (ms) vs. C1 (μF)			
R1 (kΩ)	V+ (V)	I _{OUT} (mA)	C4 (μF)	C1 = 0.01	C1 = 0.047	C1 = 0.1	C1 = 0.47
510	7	0	100	1	4	6	18
510	12	0	100	1	2	3	8
510	16	0	100	1	1	2	6
510	12	300	100	1	3	5	3
510	12	750	100	1	5	8	21
None	7	0	100	12	27	40	100
None	12	0	100	7	16	25	54
None	16	0	100	6	13	20	68
None	12	300	100	27	112	215	1114

Internal Reference

The +1.23V bandgap reference supplies up to 100μA at REF. Connect a 0.01μF bypass capacitor from REF to GND.

Oscillator

The internal oscillator of the MAX730A typically operates at 170kHz (160kHz for the MAX738A and 185kHz for the MAX744A). The MAX744A is guaranteed to operate at a minimum of 159kHz and a maximum of 212.5kHz over the operating voltage and temperature range, making it ideal for use in portable communications systems. The *Typical Operating Characteristics* graphs indicate oscillator frequency stability over temperature and supply voltage.

Applications Information

Figure 3 shows the standard 5V step-down application circuits. Table 3 lists the components for the desired operating temperature range. These circuits are useful in systems that require high current at high efficiency and are powered by an unregulated supply, such as a battery or wall-plug AC-DC transformer. These circuits operate over the entire line, load, and temperature ranges using the single set of component values shown in Figure 3 and listed in Table 3.

Inductor Selection

The MAX730A/MAX738A/MAX744A require no inductor design because they are tested in-circuit, and are guaranteed to deliver the power specified in the Electrical Characteristics with high efficiency using a

5V, Step-Down, Current-Mode PWM DC-DC Converters

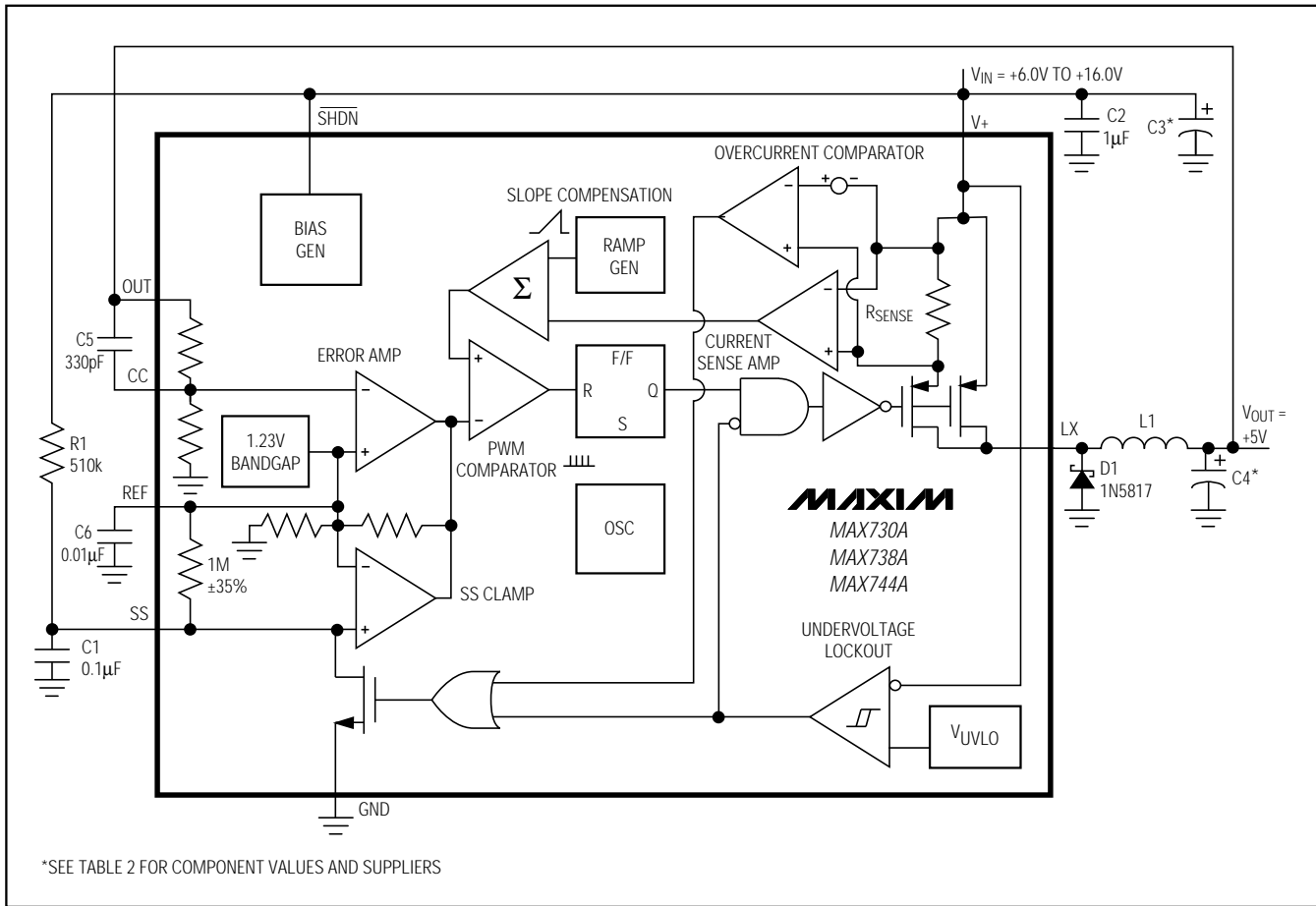

Figure 1. Detailed Block Diagram with External Components

single 100 μ H (MAX7__AC) or 33 μ H (MAX7__AE/AM) inductor. The inductor's incremental saturation current rating should be greater than 1A, and its DC resistance should be less than 0.8 Ω . Table 2 lists inductor types and suppliers for various applications. The surface-mount inductors have nearly equivalent efficiencies to the larger through-hole inductors.

Output Filter Capacitor Selection

The primary criterion for selecting the output filter capacitor is low equivalent series resistance (ESR). The product of the inductor current variation and the output capacitor's ESR determines the amplitude of the sawtooth ripple seen on the output voltage. Also, minimize the output filter capacitor's ESR to maintain AC stability. The capacitor's ESR should be less than 0.25 Ω to keep the output ripple less than 50mVp-p over the entire current range (using a 100 μ H inductor).

Capacitor ESR rises as the temperature falls, and excessive ESR is the most likely cause of trouble at temperatures below 0 $^{\circ}$ C. Sanyo OS-CON series through-hole and surface-mount tantalum capacitors exhibit low ESR at temperatures below 0 $^{\circ}$ C. Refer to Table 2 for recommended capacitor values and suggested capacitor suppliers.

Other Components

The catch diode should be a Schottky or high-speed silicon rectifier with a peak current rating of at least 1.5A for full-load (750mA) operation. The 1N5817 is a good choice. The 330pF outer-loop compensation capacitor provides the widest input voltage range and best transient characteristics. For low-current applications, the 510k Ω resistor may be omitted (see the Maximum Output Current vs. Supply Voltage graph (R1 removed) in the *Typical Operating Characteristics*).

5V, Step-Down, Current-Mode PWM DC-DC Converters

MAX730A/MAX738A/MAX744A

Table 2. Component Values and Suppliers

Production Method	MAX730AC/MAX738AC/MAX744AC Commercial Temp. Range		MAX730AE/M, MAX738AE/M, MAX744AE/M Wide Temp. Range	
	Inductors	Capacitors	Inductors	Capacitors
Surface Mount	L1 = 33μH to 100μH Sumida (708) 956-0666 CD54-101KC (MAX730AC) CD105-101KC (MAX738AC/MAX744AC) Coiltronics (407) 241-7876 CTX100 series	C3 = 68μF, 16V C4 = 100μF, 6.3V Matsuo (714) 969-2491 267 series Sprague (603) 224-1961 595D/293D series	L1 = 33μH Sumida (708) 956-0666 CD54-330N (MAX730AC) CD105-330N (MAX738AE/M, MAX744AE/M) Coiltronics (407) 241-7876 CTX50 series	C3 = 68μF, 16V C4 = 100μF, 6.3V Matsuo (714) 969-2491 267 series Sprague (603) 224-1961 595D/293D series
Miniature Through-Hole	L1 = 33μH to 100μH Sumida (708) 956-0666 RCH654-101K (MAX730A) RCH895-101K (MAX738A/MAX744A)	C3 = 150μF, 16V C4 = 150μF, 16V or 390μF, 6.3V Nichicon (708) 843-7500 PL series Low-ESR electrolytics	L1 = 33μH Sumida (708) 956-0666 RCH654-330M (MAX730A) RCH895-330M (MAX738A/MAX744A)	C3 = 150μF, 16V C4 = 220μF, 10V Sanyo (619) 661-6322 OS-CON series Low-ESR organic semiconductor (Rated from -55°C to +105°C) Mallory (317) 273-0090 THF series C3 = 100μF, 20V C4 = 220μF, 10V (Rated from -55°C to +125°C)
Low-Cost Through-Hole	L1 = 100μH Maxim MAXL001 100μH iron-power toroid Renco (516) 586-5566 RL1284-100	C3 = 150μF, 16V C4 = 390μF, 6.3V Maxim MAXC001 150μF, low-ESR electrolytic United Chemicon (708) 843-7500		

Printed Circuit Layouts

A good layout is essential for clean, stable operation. The layouts and component placement diagrams given in Figures 4, 5, 6, and 7 have been successfully tested over a wide range of operating conditions. Note that the 1μF bypass capacitor (C2) must be positioned as close to the V+ and GND pins as possible. Also, place the output capacitor as close to the OUT and GND pins as possible. The traces connecting the input and output filter capacitors and the catch diode must be short to minimize inductance and capacitance. For this reason, avoid using sockets, and solder the IC directly to the PC board. Use an uninterrupted ground plane if possible.

Output-Ripple Filtering

A simple lowpass pi-filter (Figure 3) can be added to the output to reduce output ripple to about 5mVp-p. The cutoff frequency shown is 21kHz. Since the filter inductor is in series with the circuit output, its resistance should be minimized so the voltage drop across it is not excessive.

5V, Step-Down, Current-Mode PWM DC-DC Converters

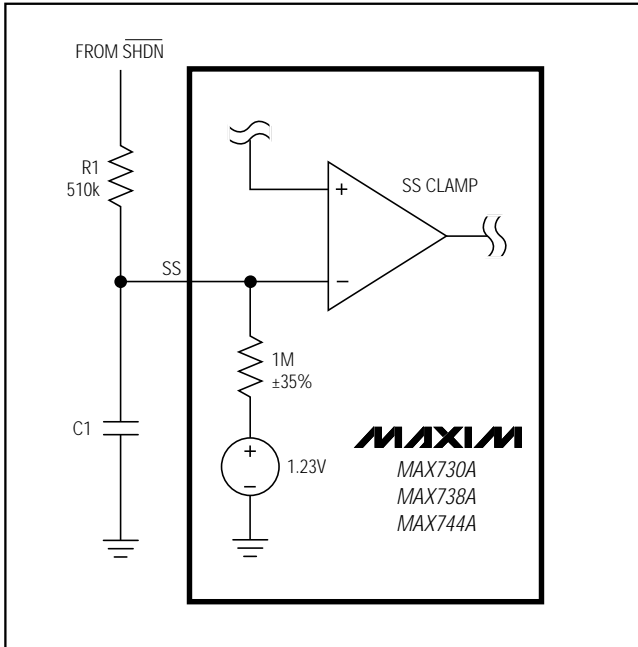
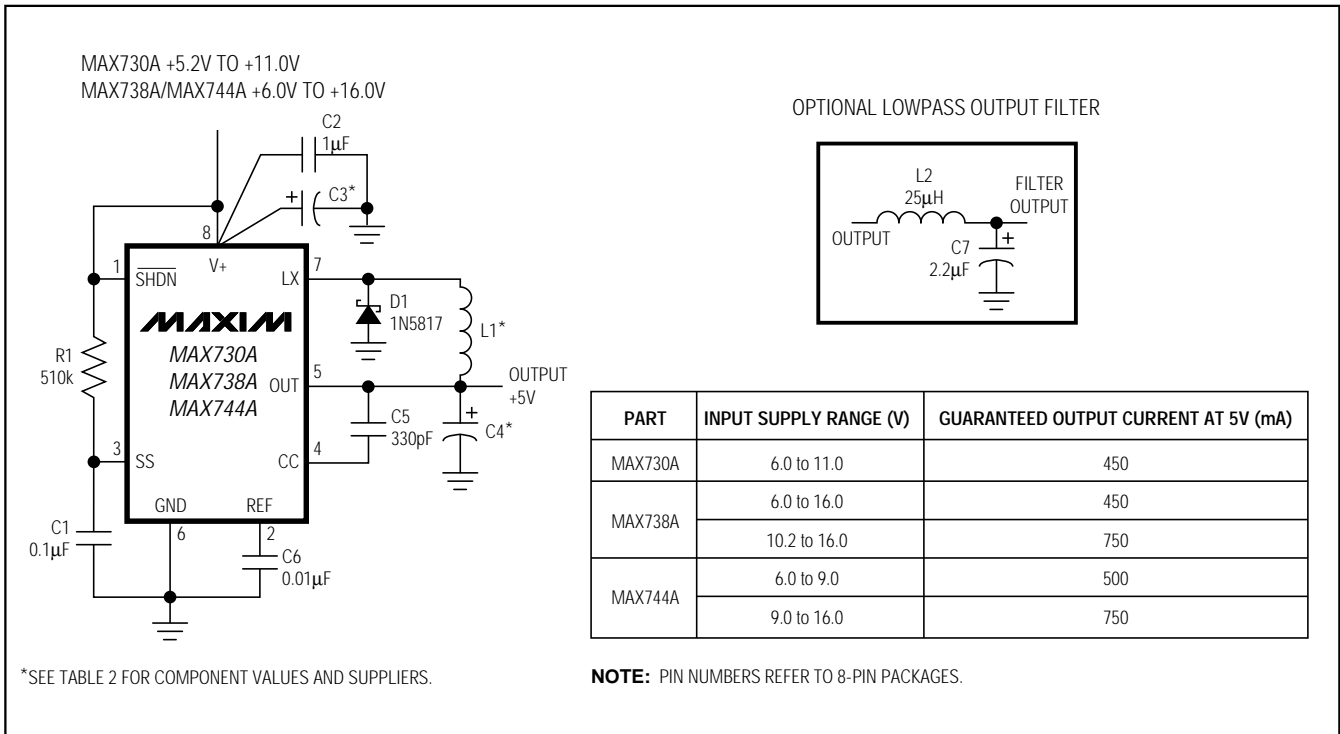

Figure 2. Block Diagram of Soft-Start Circuitry



*SEE TABLE 2 FOR COMPONENT VALUES AND SUPPLIERS.

NOTE: PIN NUMBERS REFER TO 8-PIN PACKAGES.

Figure 3. Standard +5V Step-Down Application Circuit

5V, Step-Down, Current-Mode PWM DC-DC Converters

MAX730A/MAX738A/MAX744A

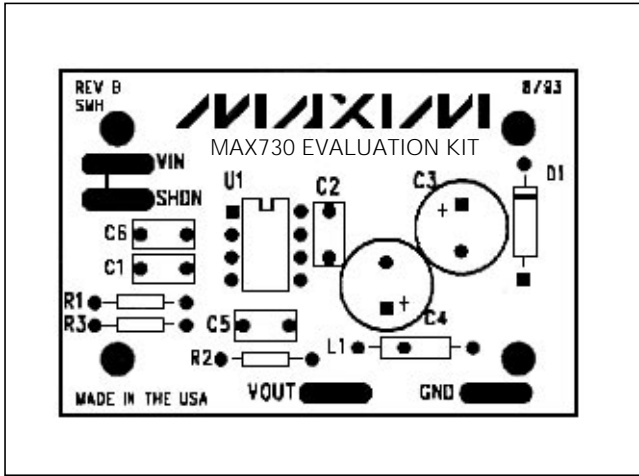

Figure 4. DIP PC Layout, Through-Hole Component Placement Diagram (1x scale)

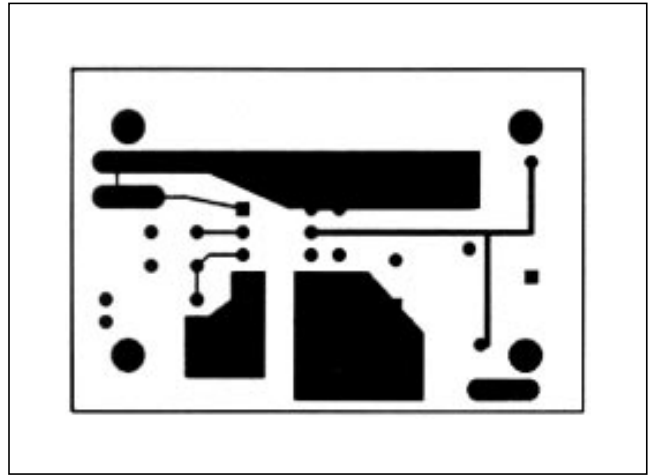

Figure 5. DIP PC Layout, Component Side (1x scale)

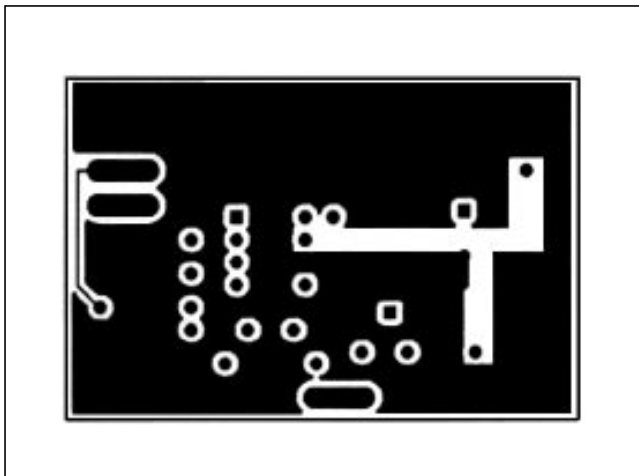

Figure 6. DIP PC Layout, Solder Side (1x scale)

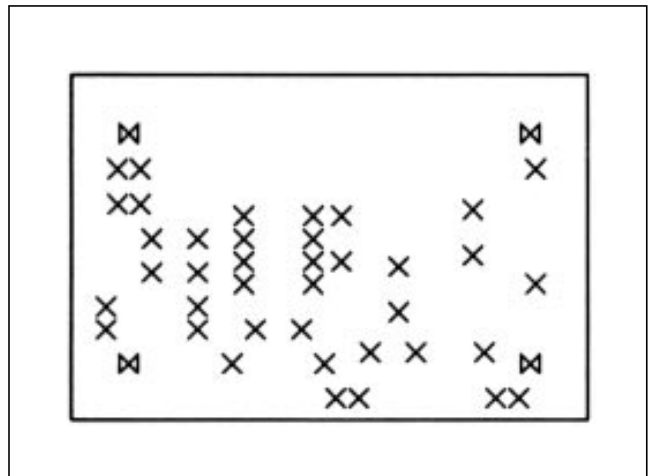
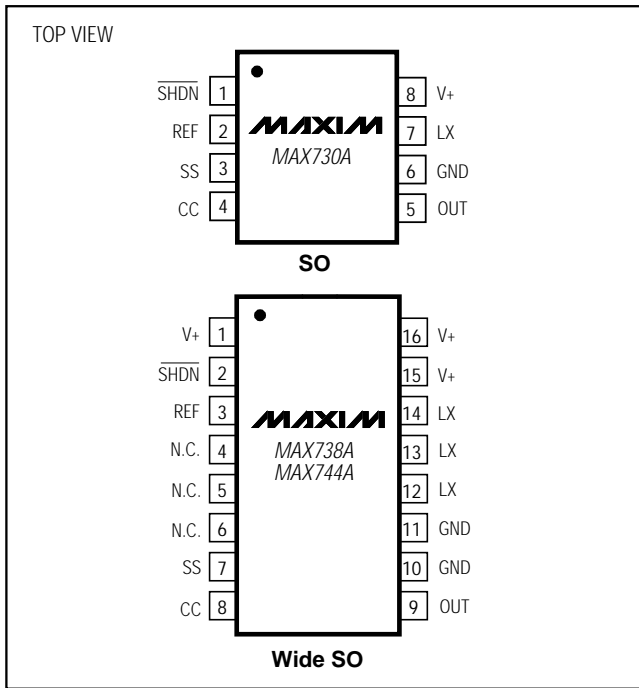

Figure 7. DIP PC Layout, Drill Guide (1x scale)

5V, Step-Down, Current-Mode PWM DC-DC Converters

Pin Configurations (continued)



Ordering Information (continued)

PART	TEMP. RANGE	PIN-PACKAGE
MAX738ACPA	0°C to +70°C	8 Plastic DIP
MAX738ACWE	0°C to +70°C	16 Wide SO
MAX738AC/D	0°C to +70°C	Dice*
MAX738AEPA	-40°C to +85°C	8 Plastic DIP
MAX738AEWE	-40°C to +85°C	16 Wide SO
MAX738AMJA	-55°C to +125°C	8 CERDIP
MAX744ACPA	0°C to +70°C	8 Plastic DIP
MAX744ACWE	0°C to +70°C	16 Wide SO
MAX744AC/D	0°C to +70°C	Dice*
MAX744AEPA	-40°C to +85°C	8 Plastic DIP
MAX744AEWE	-40°C to +85°C	16 Wide SO
MAX744AMJA	-55°C to +125°C	8 CERDIP

*Contact factory for dice specifications.

Chip Topographies

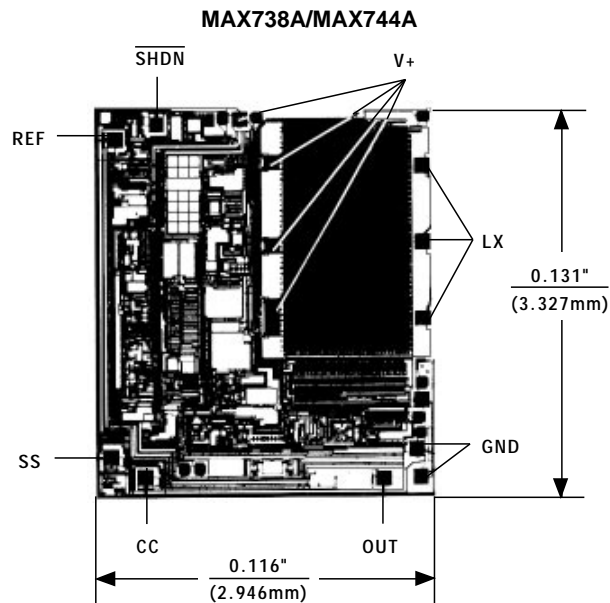
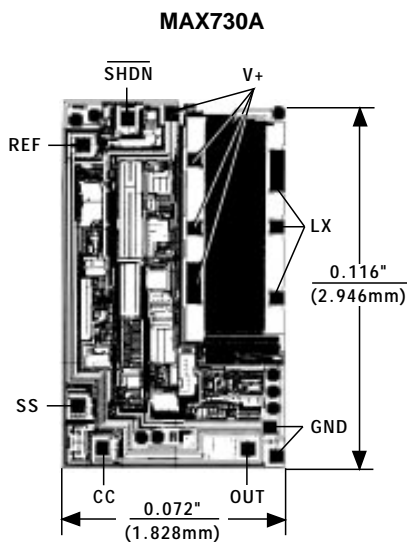

TRANSISTOR COUNT: 274 (MAX730A)
286 (MAX738A/MAX744A);
SUBSTRATE CONNECTED TO V+.

5V, Step-Down, Current-Mode PWM DC-DC Converters

Package Information

MAX730A/MAX738A/MAX744A

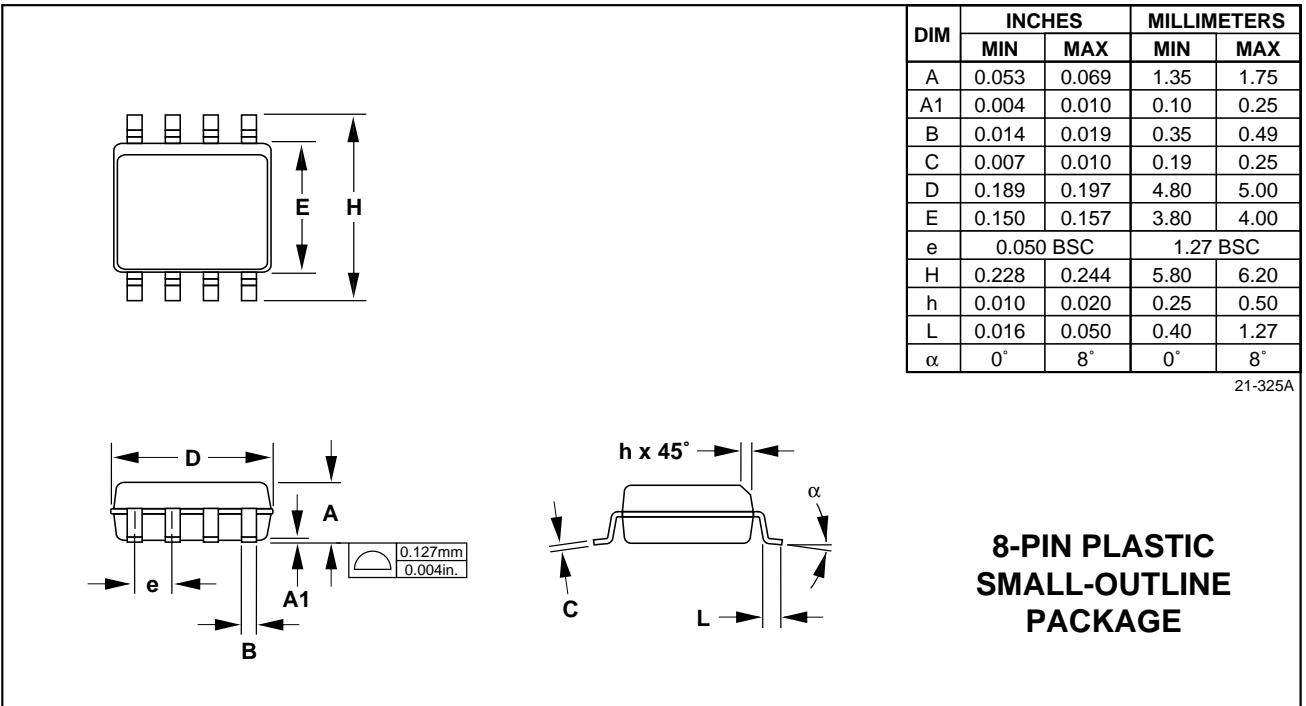
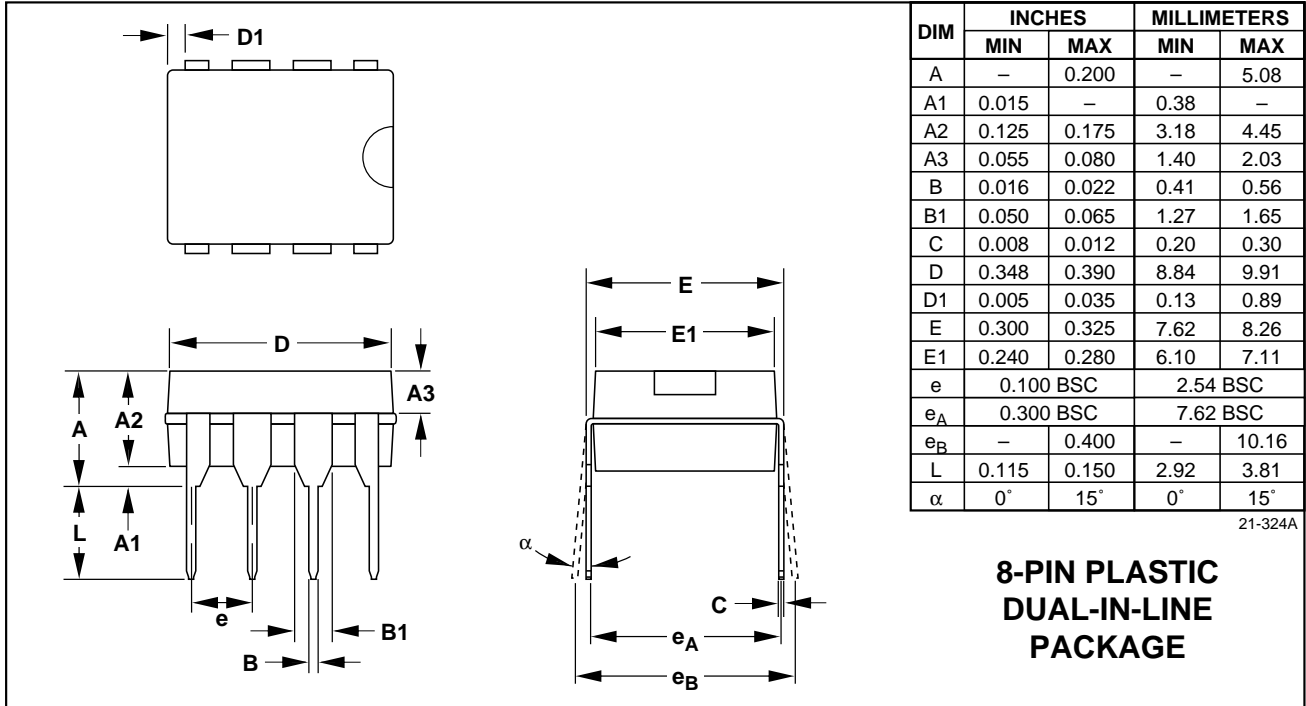

5V, Step-Down, Current-Mode PWM DC-DC Converters

Package Information (continued)

DIM	INCHES		MILLIMETERS	
	MIN	MAX	MIN	MAX
A	–	0.200	–	5.08
B	0.014	0.023	0.36	0.58
B1	0.038	0.065	0.97	1.65
B2	0.023	0.045	0.58	1.14
C	0.008	0.015	0.20	0.38
D	–	0.405	–	10.29
E	0.220	0.310	5.59	7.87
E1	0.290	0.320	7.37	8.13
e	0.100 BSC		2.54 BSC	
L	0.125	0.200	3.18	5.08
L1	0.150	–	3.81	–
Q	0.015	0.060	0.38	1.52
S	–	0.055	–	1.40
S1	0.005	–	0.13	–
α	0°	15°	0°	15°

21-326D

**8-PIN CERAMIC
DUAL-IN-LINE
PACKAGE**

DIM	INCHES		MILLIMETERS	
	MIN	MAX	MIN	MAX
A	0.093	0.104	2.35	2.65
A1	0.004	0.012	0.10	0.30
B	0.014	0.019	0.35	0.49
C	0.009	0.013	0.23	0.32
D	0.398	0.413	10.10	10.50
E	0.291	0.299	7.40	7.60
e	0.050 BSC		1.27 BSC	
H	0.394	0.419	10.00	10.65
h	0.010	0.030	0.25	0.75
L	0.016	0.050	0.40	1.27
α	0°	8°	0°	8°

21-589B

**16-PIN PLASTIC
SMALL-OUTLINE
(WIDE)
PACKAGE**

Maxim cannot assume responsibility for use of any circuitry other than circuitry entirely embodied in a Maxim product. No circuit patent licenses are implied. Maxim reserves the right to change the circuitry and specifications without notice at any time.

16 Maxim Integrated Products, 120 San Gabriel Drive, Sunnyvale, CA 94086 (408) 737-7600

© 1996 Maxim Integrated Products

Printed USA

MAXIM is a registered trademark of Maxim Integrated Products.