

16-Port, 36V Constant-Current LED Driver with LED Fault Detection and Watchdog

General Description

The MAX6983 serial-interfaced LED driver provides 16 open-drain, constant-current-sinking LED driver outputs rated at 36V. The MAX6983 operates from a 3V to 5.5V supply. The MAX6983 supply and the LEDs' supply can power up in any order. The constant-current outputs are programmed together to up to 55mA using a single external resistor. The MAX6983 operates with a 25Mb, industry-standard, 4-wire serial interface.

The MAX6983 includes circuitry that automatically detects open-circuit LEDs. Fault status is loaded into the serial-interface shift register when LE goes high and is automatically shifted out on DOUT when the next data transmission is shifted in.

The MAX6983 includes a fail-safe feature for safety-related applications, which blanks the display if the serial interface fails. If the serial interface becomes inactive for more than 1s, all driver output latches are automatically cleared. This turns off all LEDs connected to the outputs. The shift register data is not disturbed. The outputs remain off until the driver output latches are updated with data turning them on, so recovery is automatic if the transmission failure is temporary. The watchdog function requires no software change to the application driving the MAX6983.

The MAX6983 uses the industry-standard shift-register-plus-latch-type serial interface. The driver accepts data shifted into a 16-bit shift register using data input DIN and clock input CLK. Input data appears at the output DOUT 16 clock cycles later to allow cascading of multiple MAX6983s. The latch-enable input, LE, loads the 16 bits of shift-register data into a 16-bit output latch to set which LEDs are on and which are off. The output-enable input, \overline{OE} , gates all 16 outputs on and off, and is fast enough to be used as a PWM input for LED intensity control.

The MAX6983 is one of a family of 12 shift-register-plus-latch-type LED drivers. The family includes 8-port and 16-port types, with 5.5V- or 36V-rated LED outputs, with and without open-circuit LED detection and watchdog. All versions operate from a 3V to 5.5V supply, and are specified over the -40°C to +125°C temperature range.

Applications

- Variable Message Signs
- Marquee Displays
- Point-of-Order Signs
- Traffic Signs
- Gaming Features
- Architectural Lighting

Features

- ◆ 25Mb Industry-Standard, 4-Wire Serial Interface
- ◆ 3V to 5.5V Logic Supply
- ◆ 16 Constant-Current LED Outputs Rated at 36V
- ◆ Up to 55mA Continuous Current per Output
- ◆ Output Current Programmed by Single Resistor
- ◆ 3% Current Matching Between Outputs
- ◆ 6% Current Matching Between ICs
- ◆ Watchdog Clears Display if Interface Fails
- ◆ Reports Open-Circuit LED Faults
- ◆ High-Dissipation, 24-Pin Packages
- ◆ -40°C to +125°C Temperature Range

MAX6983

Ordering Information

PART	TEMP RANGE	PIN- PACKAGE	PKG CODE
MAX6983AUG	-40°C to +125°C	24 TSSOP	—
MAX6983ANG	-40°C to +125°C	24 Narrow PDIP	—

Typical Application Circuit and Selector Guide appear at end of data sheet.

Pin Configuration

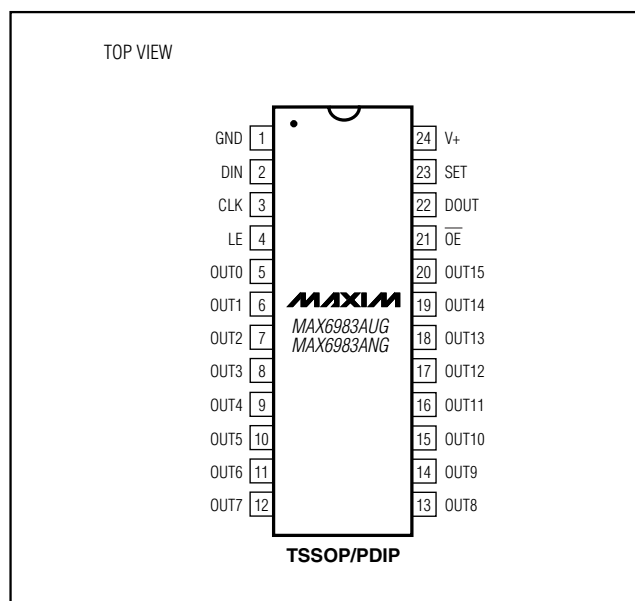

16-Port, 36V Constant-Current LED Driver with LED Fault Detection and Watchdog

MAX6983

ABSOLUTE MAXIMUM RATINGS

Voltage (with respect to GND)		Continuous Power Dissipation ($T_A = +70^\circ\text{C}$)	
V+	-0.3V to +6V	24-Pin PDIP (derate 13.3mW/ $^\circ\text{C}$ over $+70^\circ\text{C}$).....	1067mW
OUT_	-0.3V to +40V	24-Pin TSSOP (derate 12.2mW/ $^\circ\text{C}$ over $+70^\circ\text{C}$)	975mW
DIN, CLK, LE, $\overline{\text{OE}}$, SE	-0.3V to (V+ + 0.3V)	Operating Temperature Range	-40 $^\circ\text{C}$ to +125 $^\circ\text{C}$
DOUT_ Current	$\pm 10\text{mA}$	Junction Temperature	+150 $^\circ\text{C}$
OUT_ Sink Current	60mA	Storage Temperature Range	-65 $^\circ\text{C}$ to +150 $^\circ\text{C}$
Total GND Current	960mA	Lead Temperature (soldering, 10s)	+300 $^\circ\text{C}$

Stresses beyond those listed under "Absolute Maximum Ratings" may cause permanent damage to the device. These are stress ratings only, and functional operation of the device at these or any other conditions beyond those indicated in the operational sections of the specifications is not implied. Exposure to absolute maximum rating conditions for extended periods may affect device reliability.

ELECTRICAL CHARACTERISTICS

(Typical Operating Circuit, V+ = 3V to 5.5V, $T_A = T_{\text{MIN}}$ to T_{MAX} , unless otherwise noted. Typical values are at V+ = 5V, $T_A = +25^\circ\text{C}$.) (Note 1)

PARAMETER	SYMBOL	CONDITIONS	MIN	TYP	MAX	UNITS
Operating Supply Voltage	V+		3.0		5.5	V
Output Voltage	V _{OUT}				36	V
Standby Current (Interface Idle, All Output Ports High Impedance, R _{SET} = 360 Ω)	I ₊	All logic inputs at V+ or GND, DOUT_ unloaded		5.7	8	mA
Standby Current (Interface Running, All Output Ports High Impedance, R _{SET} = 360 Ω)	I ₊	f _{CLK} = 25MHz, $\overline{\text{OE}}$ = V+, DIN and LE = V+ or GND, DOUT_ unloaded		6	6.5	mA
Supply Current (Interface Idle, All Output Ports Active Low, R _{SET} = 360 Ω)	I ₊	All logic inputs at V+ or GND, DOUT_ unloaded		18	25	mA
Input High Voltage DIN_, CLK_, LE_, $\overline{\text{OE}}$ _	V _{IH}		0.7 x V+			V
Input Low Voltage DIN_, CLK_, LE_, $\overline{\text{OE}}$ _	V _{IL}				0.3 x V+	V
Hysteresis Voltage DIN_, CLK_, LE_, $\overline{\text{OE}}$ _	ΔV_I			0.8		V
Input Leakage Current DIN_, CLK_, LE_, $\overline{\text{OE}}$ _	I _{IH} , I _{IL}		-1		+1	μA
Output High-Voltage DOUT_	V _{OH}	I _{SOURCE} = 4mA	V+ -0.5V			V
Output Low-Voltage	V _{OL}	I _{SINK} = 4mA			0.5	V
Output Current OUT_	I _{OUT}	V+ = 3V - 5.5V, V _{OUT} = 0.8V - 2.5V, R _{SET} = 360 Ω	37	50	61	mA
Output Leakage Current OUT_	I _{LEAK}	$\overline{\text{OE}}$ = V+			1	μA
Watchdog Timeout	t _{WD}		0.1	1	2.5	s

16-Port, 36V Constant-Current LED Driver with LED Fault Detection and Watchdog

5V TIMING CHARACTERISTICS

(Typical Operating Circuit, $V_+ = 4.5V$ to $5.5V$, $T_A = T_{MIN}$ to T_{MAX} , unless otherwise noted.) (Notes 1, 2)

PARAMETER	SYMBOL	CONDITIONS	MIN	TYP	MAX	UNITS
CLK_ Clock Period	t _{CP}		40			ns
CLK_ Pulse-Width High	t _{CH}		19			ns
CLK_ Pulse-Width Low	t _{CL}		19			ns
DIN_ Setup Time	t _{DS}		4			ns
DIN_ Hold Time	t _{DH}		8			ns
DOUT_ Propagation Delay	t _{DO}		12		32	ns
DOUT_ Rise and Fall Time		C _{DOUT} = 10pF, 20% to 80%			10	ns
LE Setup Time	t _{LS}		10			ns
LE Rising to OUT_ Rising Delay	t _{LRR}	(Note 3)			100	ns
LE Rising to OUT_ Falling Delay	t _{LRF}	(Note 3)			300	ns
CLK_ Rising to OUT_ Rising Delay	t _{CRR}	(Note 3)			100	ns
CLK_ Rising to OUT_ Falling Delay	t _{CRF}	(Note 3)			310	ns
\overline{OE} _ Rising to OUT_ Rising Delay	t _{OE\overline{H}}	(Note 3)			100	ns
\overline{OE} _ Falling to OUT_ Falling Delay	t _{OE\overline{L}}	(Note 3)			320	ns
LED Output OUT_ Turn-On Fall Time	t _f	80% to 20%; pullup resistor = 65 Ω (Note 3)			120	ns
LED Output OUT_ Turn-Off Rise Time	t _r	20% to 80%; pullup resistor = 65 Ω (Note 3)			120	ns

MAX6983

16-Port, 36V Constant-Current LED Driver with LED Fault Detection and Watchdog

MAX6983

3.3V TIMING CHARACTERISTICS

(Typical Operating Circuit, $V_+ = 3V$ to $5.5V$, $T_A = T_{MIN}$ to T_{MAX} , unless otherwise noted.) (Notes 1, 2)

PARAMETER	SYMBOL	CONDITIONS	MIN	TYP	MAX	UNITS
CLK_ Clock Period	t_{CP}		52			ns
CLK_ Pulse-Width High	t_{CH}		24			ns
CLK_ Pulse-Width Low	t_{CL}		24			ns
DIN_ Setup Time	t_{DS}		4			ns
DIN_ Hold Time	t_{DH}		8			ns
DOUT_ Propagation Delay	t_{DO}		12		50	ns
DOUT_ Rise and Fall Time		$C_{DOUT} = 10pF$, 20% to 80%			12	ns
LE Setup Time	t_{LS}		15			ns
LE Rising to OUT_ Rising Delay		(Note 3)			120	ns
LE Rising to OUT_ Falling Delay		(Note 3)			310	ns
CLK_ Rising to OUT_ Rising Delay		(Note 3)			120	ns
CLK_ Rising to OUT_ Falling Delay		(Note 3)			330	ns
\overline{OE}_- Rising to OUT_ Rising Delay	t_{OE_H}	(Note 3)			120	ns
\overline{OE}_- Falling to OUT_ Falling Delay	t_{OE_L}	(Note 3)			330	ns
LED Output OUT_ Turn-On Fall Time	t_f	80% to 20% (Note 3)			120	ns
LED Output OUT_ Turn-Off Rise Time	t_r	20% to 80% (Note 3)			120	ns

Note 1: All parameters tested at $T_A = +25^\circ C$. Specifications over temperature are guaranteed by design.

Note 2: See Figure 3.

Note 3: A 65Ω pullup resistor is connected from OUT_ to 5.5V.

Typical Operating Characteristics

($T_A = +25^\circ C$, unless otherwise noted.)

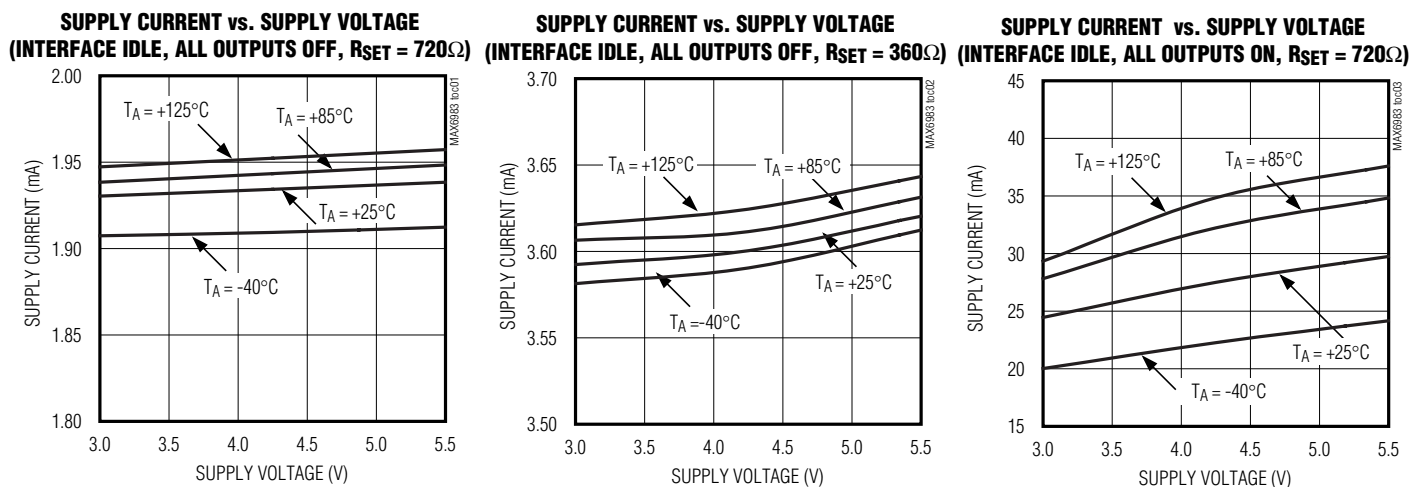

16-Port, 36V Constant-Current LED Driver with LED Fault Detection and Watchdog

Typical Operating Characteristics (continued)

($T_A = +25^\circ\text{C}$, unless otherwise noted.)

SUPPLY CURRENT vs. SUPPLY VOLTAGE
(INTERFACE IDLE, ALL OUTPUTS ON, $R_{SET} = 360\Omega$)

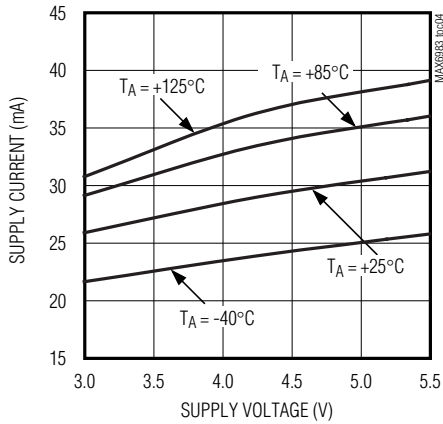

PORT OUTPUT CURRENT vs. PORT OUTPUT VOLTAGE
($R_{SET} = 720\Omega$, $V_+ = 3.3\text{V}$)

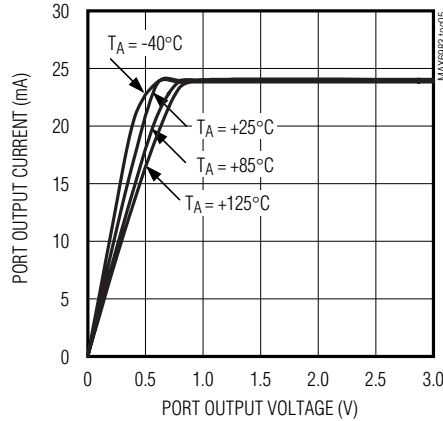

PORT OUTPUT CURRENT vs. PORT OUTPUT VOLTAGE
($R_{SET} = 360\Omega$, $V_+ = 3.3\text{V}$)

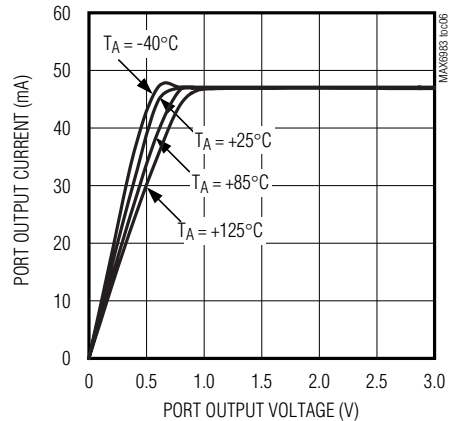

PORT OUTPUT CURRENT vs. PORT OUTPUT VOLTAGE
($R_{SET} = 720\Omega$, $V_+ = 5.0\text{V}$)

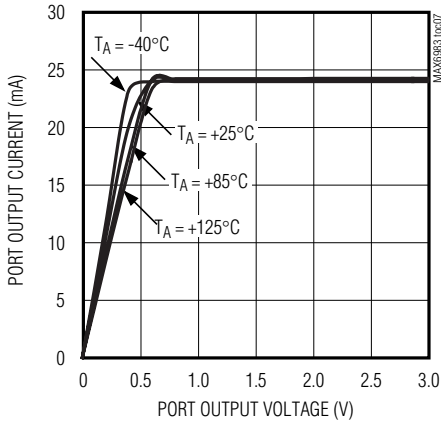

PORT OUTPUT CURRENT vs. PORT OUTPUT VOLTAGE
($R_{SET} = 360\Omega$, $V_+ = 5.0\text{V}$)

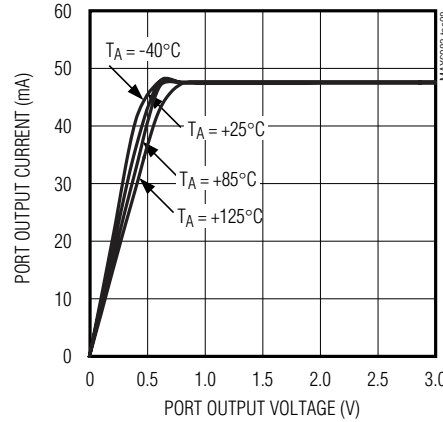

PORT OUTPUT CURRENT vs. PORT OUTPUT VOLTAGE
($R_{SET} = 720\Omega$, $V_{OUT} = 2\text{V}$)

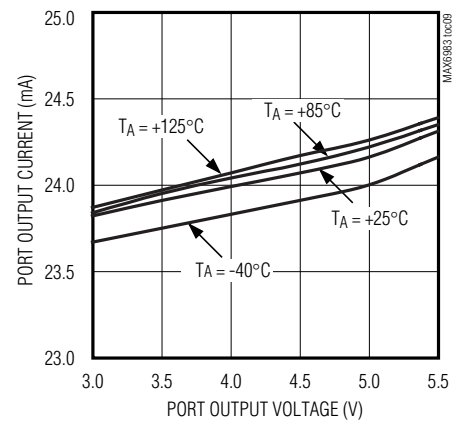

PORT OUTPUT CURRENT vs. PORT OUTPUT VOLTAGE
($R_{SET} = 360\Omega$, $V_{OUT} = 2\text{V}$)

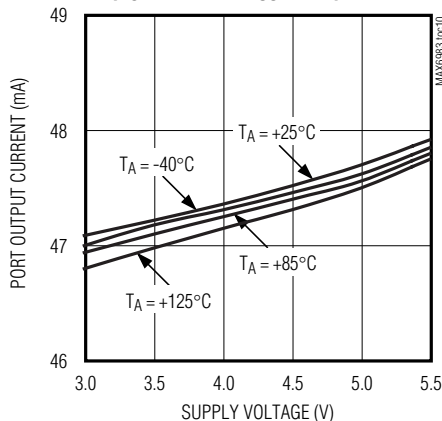

PORT OUTPUT CURRENT vs. R_{SET} RESISTANCE
($V_+ = 5.0\text{V}$)

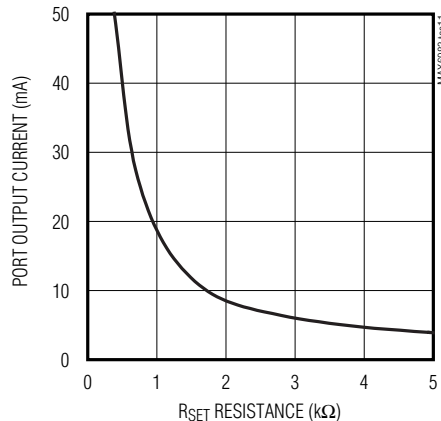

16-Port, 36V Constant-Current LED Driver with LED Fault Detection and Watchdog

MAX6983

Pin Description

PIN	NAME	FUNCTION
1	GND	Ground
2	DIN	Serial-Data Input. Data is loaded into the internal 16-bit shift register on CLK's rising edge.
3	CLK	Serial-Clock Input. Data is loaded into the internal 16-bit shift register on CLK's rising edge.
4	LE	Load-Enable Input. Data is loaded transparently from the internal shift register(s) to the output latch(es) while LE is high. Data is latched into the output latch(es) on LE's falling edge, and retained while LE is low.
5–20	OUT0–OUT15	LED Driver Outputs. OUT0 to OUT15 are open-drain, constant-current sinking outputs rated to 28V.
21	\overline{OE}	Output Enable Input. High forces outputs OUT0 to OUT15 high impedance, without altering the contents of the output latches. Low enables outputs OUT0 to OUT15 to follow the state of the output latches.
22	DOUT	Serial-Data Output. Data is clocked out of the 16-bit internal shift-register to DOUT on CLK's rising edge.
23	SET	LED Current Setting. Connect SET to GND through a resistor (RSET) to set the maximum LED current.
24	V+	Positive Supply Voltage. Bypass V+ to GND with a 0.1 μ F ceramic capacitor.

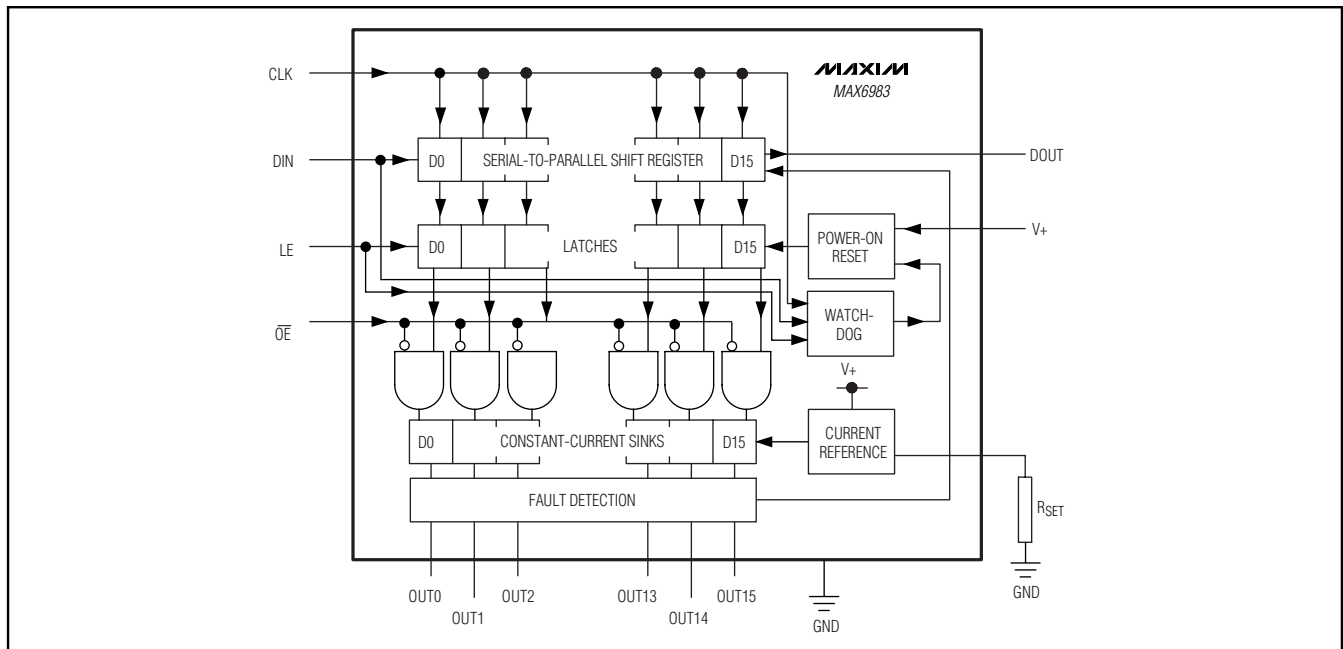

Figure 1. Block Diagram

16-Port, 36V Constant-Current LED Driver with LED Fault Detection and Watchdog

MAX6983

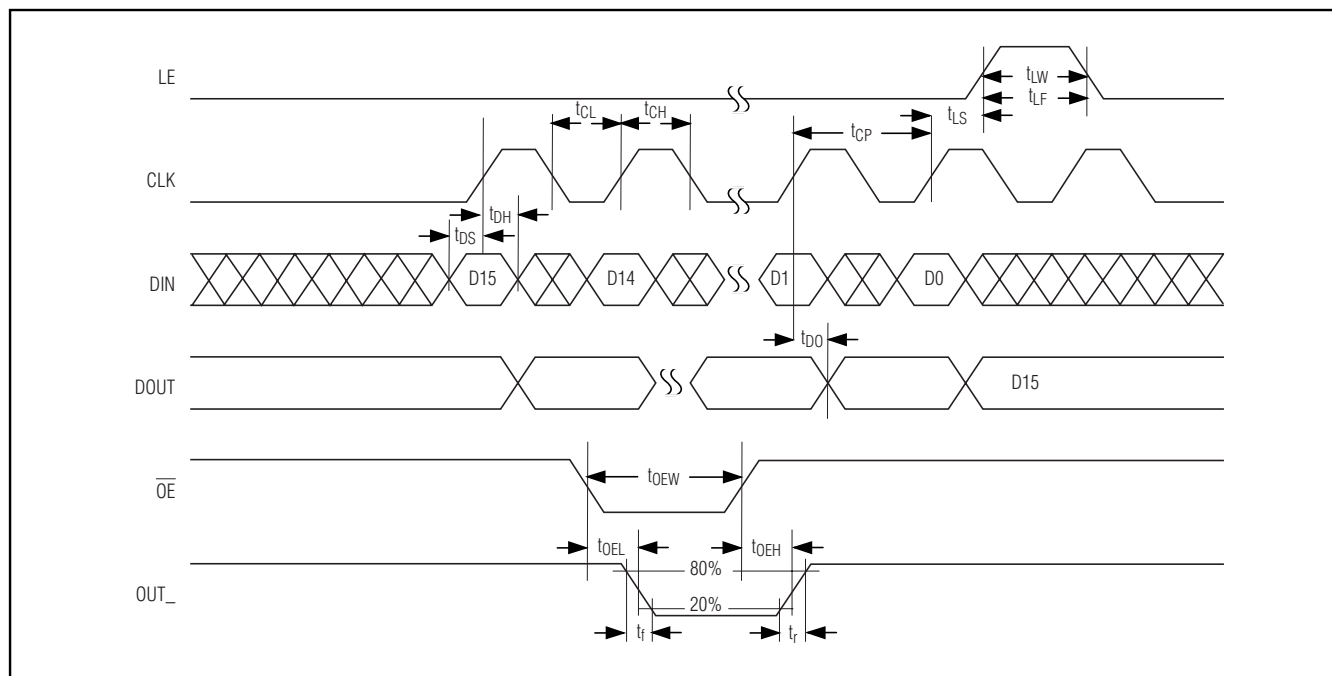

Figure 2. 4-Wire Serial-Interface Timing Diagram

Detailed Description

The MAX6983 LED driver comprises a 4-wire serial interface driving eight constant-current sinking open-drain output ports. The outputs drive LEDs in either static or multiplex applications (Figure 1). The constant-current outputs are guaranteed for current accuracy not only with chip-supply voltage variations ($5V \pm 10\%$ and $3V$ to $5.5V$), but also over a realistic range of driver output voltage drop ($0.8V$ to $2.5V$). The drivers use current-sensing feedback circuitry (not simple current mirrors) to ensure very small current variations over the full allowed range of output voltage (see the *Typical Operating Characteristics*).

The 4-wire serial interface comprises a 16-bit shift register and a 16-bit transparent latch. The shift register is written through a clock input CLK and a data input DIN and the data propagates to a data output DOUT. The data output allows multiple drivers to be cascaded and operated together. The contents of the 16-bit shift register are loaded into the transparent latch through a latch-enable input LE. The latch is transparent to the shift register outputs when high, and latches the current state on the falling edge of LE.

Each driver output is an open-drain, constant-current sink that should be connected to the cathode of either

a single LED or a series string of multiple LEDs. The LED anode can be connected to a supply voltage of up to $36V$, independent of the MAX6983 supply, $V+$. The constant-current capability is up to $55mA$ per output, set for all 16 outputs by an external resistor, R_{SET} .

4-Wire Serial Interface

The serial interface on the MAX6983 is a 4-wire serial interface using four inputs (DIN, CLK, LE, and \overline{OE}) and a data output (DOUT). This interface is used to write display data to the MAX6983. The serial-interface data word length is 16 bits, D0–D15. See Figure 2.

The functions of the five interface pins are as follows. DIN is the serial-data input, and must be stable when it is sampled on the rising edge of CLK. Data is shifted in, MSB first. This means that data bit D15 is clocked in first, followed by 15 more data bits, finishing with the LSB D0.

CLK is the serial-clock input, which shifts data at DIN into the MAX6983 16-bit shift register on its rising edge.

LE is the latch load input of the MAX6983, which transfers data from the MAX6983 16-bit shift register to its 16-bit latch when LE is high (transparent latch), and latches the data on the falling edge of LE (Figure 2).

16-Port, 36V Constant-Current LED Driver with LED Fault Detection and Watchdog

MAX6983

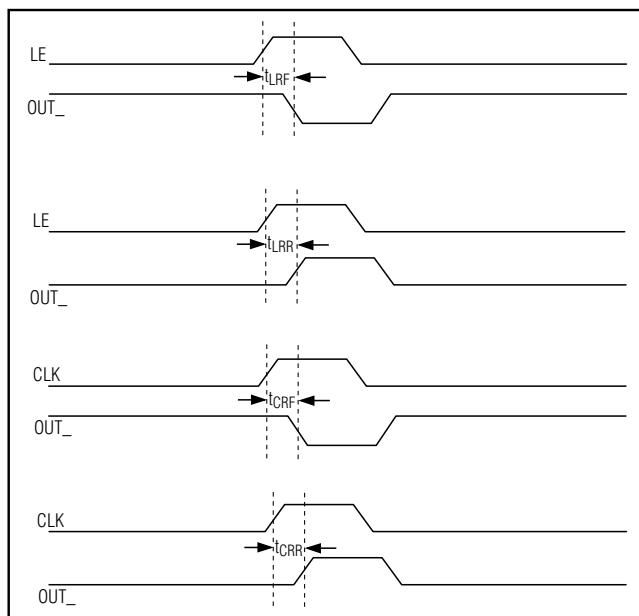

Figure 3. LE and CLK to OUT_ Timing

The fourth input provides output-enable control of the output drivers. \overline{OE} is high to force outputs OUT0–OUT15 high impedance, without altering the contents of the output latches, and low to enable outputs OUT0–OUT15 to follow the state of the output latches.

\overline{OE} is independent of the operation of the serial interface. Data can be shifted into the serial-interface shift register and latched regardless of the state of \overline{OE} .

DOUT is the serial-data output, which shifts data out from the MAX6983's 16-bit shift register on the rising edge of CLK. Data at DIN is propagated through the shift register and appears at DOUT 16 clock cycles later. See Figure 2.

Watchdog

The MAX6983 includes a watchdog circuit that monitors the CLK, DIN, and LE inputs. If there is no transition on any one of these inputs for nominally 1s, the output latches are cleared and outputs OUT0–OUT15 go high impedance like the initial power-up condition. This turns off all LEDs connected to the outputs. The shift-register data does not change, just the output-latch data.

The watchdog is intended to be used as a fail-safe feature for applications that prefer a blank display to an incorrect display if the serial interface fails. When the watchdog triggers, the outputs remain off until the driver output latches are updated with data turning them

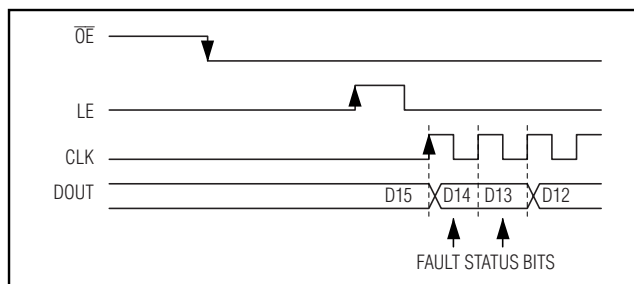

Figure 4. Fault Timing

on. Recovery is therefore automatic if the transmission failure is temporary because the MAX6983 does not lock up in the watchdog timeout state. The MAX6983 operates correctly when the serial interface is next activated, and the watchdog circuit is reset and starts monitoring the serial interface again. The watchdog function requires no software change to the application driving the MAX6983.

LED Fault Detection

The MAX6983 includes circuitry that detects open-circuit LEDs automatically. An open-circuit fault occurs when an output is programmed to sink current but less than about 50% of the programmed current flows. Open circuits are checked just after the falling edge of \overline{OE} . The fault data is latched on the rising edge of LE and is shifted out when new LED data is loaded into the output latches from the shift register. If one or more output ports are detected with an open-circuit fault, the D14 and D13 bits of DOUT go high. If no open-circuit faults are detected, D14 and D13 are set to low. The data in the other 14 bit positions in DOUT are not altered.

Fault status is shifted out on DOUT when the next data transmission is shifted in after the rising edge of LE. LE is normally taken high after all 16 bits of new LED data have been clocked into the shift register(s), and then DOUT outputs data bit D15. On the next two rising edges of CLK, the 2 fault status bits, D14 and D13, are clocked out in that order, followed by the remaining 13 unchanged data bits D12 to D0.

A typical fault-detecting application tests all the shifted out data. Bits D0–D12 and D15 are checked against the originally transmitted data to check data-link integrity. Bits D13 and D14 are checked first to see that they contain the same data (validating the status) and second, whether faults are reported or not by the actual logic level.

Figure 4 is the LE and CLK to OUT_ timing diagram.

16-Port, 36V Constant-Current LED Driver with LED Fault Detection and Watchdog

MAX6983

Table 1. 4-Wire Serial-Interface Truth Table

SERIAL DATA INPUT DIN	CLOCK INPUT CLK	SHIFT REGISTER CONTENTS						LOAD INPUT LE	LATCH CONTENTS						BLANKING INPUT \overline{OE}	OUTPUT CONTENTS							
		D ₀	D ₁	D ₂	...	D _{n-1}	D _n		D ₀	D ₁	D ₂	...	D _{n-1}	D _n		D ₀	D ₁	D ₂	...	D _{n-1}	D _n		
H		H	R ₁	R ₂	...	R _{n-2}	R _{n-1}	—	—	—	—	—	—	—	—	—	—	—	—	—	—	—	—
L		L	R ₁	R ₂	...	R _{n-2}	R _{n-1}	—	—	—	—	—	—	—	—	—	—	—	—	—	—	—	—
X		R ₀	R ₁	R ₂	...	R _{n-1}	R _n	—	—	—	—	—	—	—	—	—	—	—	—	—	—	—	—
—	—	X	X	X	...	X	X	H	R ₀	R ₁	R ₂	...	R _{n-1}	R _n	—	—	—	—	—	—	—	—	—
—	—	P ₁	P ₂	P ₃	...	P _{n-1}	P _n	L	P ₀	P ₁	P ₂	...	P _{n-1}	P _n	L	$\overline{P_0}$	$\overline{P_1}$	$\overline{P_2}$...	$\overline{P_{n-1}}$	$\overline{P_n}$	—	—
—	—	—	—	—	—	—	—	—	X	X	X	...	X	X	H	Hi-Z	Hi-Z	Hi-Z	...	Hi-Z	Hi-Z	—	—

L = Low-logic level; H = High-logic level; X = Don't care; P = Present state; R = Previous state.

Applications Information

Selecting External Component R_{SET} to Set LED Output Current

The MAX6983 uses an external resistor, R_{SET}, to set the LED current for outputs OUT₀–OUT₁₅. The minimum allowed value of R_{SET} is 327.3Ω, which sets the output currents to 55mA. The maximum allowed value of R_{SET} is 5kΩ. The reference value, 360Ω, sets the output currents to 50mA. To set a different output current, use the formula:

$$R_{SET} = 18,000 / I_{OUT}$$

where I_{OUT} is the desired output current in mA.

Computing Power Dissipation

The upper limit for power dissipation (P_D) for the MAX6983 is determined by the following equation:

$$P_D = (V_+ \times I_+) + (V_{OUT} \times DUTY \times I_{OUT} \times N)$$

where:

V₊ = supply voltage

I₊ = operating supply current when sinking I_{OUT} LED drive current into N outputs

DUTY = PWM duty cycle applied to \overline{OE}

N = number of MAX6983 outputs driving LEDs at the same time (maximum is 16)

V_{OUT} = MAX6983 port output voltage when driving load LED(s)

I_{OUT} = LED drive current programmed by R_{SET}

P_D = power dissipation, in mW if currents are in mA

Dissipation example:

$$I_{OUT} = 20\text{mA}, N = 16, DUTY = 1, \\ V_{OUT} = 2\text{V}, V_+ = 5.25\text{V}$$

$P_D = (5.25\text{V} \times 25\text{mA}) + (2\text{V} \times 1 \times 20\text{mA} \times 16) = 0.77\text{W}$
Thus, for a 24-pin TSSOP package ($T_{JA} = 1 / 0.0122 = +82^\circ\text{C}/\text{W}$ from the *Absolute Maximum Ratings*), the maximum allowed ambient temperature T_A is given by:

$$T_{J(\text{MAX})} = T_A + (P_D \times T_{JA}) = +150^\circ\text{C} = \\ T_A + (0.77 \times 82^\circ\text{C}/\text{W})$$

so T_A = +85°C.

Overtemperature Cutoff

The MAX6983 contains an internal temperature sensor that turns off all outputs when the die temperature exceeds approximately +165°C. The outputs are enabled again when the die temperature drops below approximately +140°C. Register contents are not affected, so when a driver is overdissipating, the external symptom is the load LEDs cycling between on and off as the driver repeatedly overheats and cools, alternately turning the LEDs off and then back on again.

Power-Supply Considerations

The MAX6983 operates with a chip supply V₊, and one or more LED supplies. Bypass each supply to GND with a 0.1μF capacitor as close to the MAX6983 as possible. This is normally adequate for static LED driving. For multiplex or PWM applications, it is necessary to add an additional bulk electrolytic capacitor of 4.7μF or more to each supply for every 4 to 16 MAX6983s. The necessary capacitance depends on the LED load current, PWM switching frequency, and serial interface speed. Inadequate V₊ decoupling can cause timing problems, and very noisy LED supplies can affect LED current regulation.

16-Port, 36V Constant-Current LED Driver with LED Fault Detection and Watchdog

MAX6983

Selector Guide

PART	NUMBER OF OUTPUTS	MAX OUTPUT VOLTAGE (V)	MAX OUTPUT CURRENT	LED FAULT DETECTION	WATCHDOG
MAX6968	8	5.5	55mA	—	—
MAX6977				Yes	—
MAX6978				Yes	Yes
MAX6970*	8	36		—	—
MAX6981*				Yes	—
MAX6980*				Yes	Yes
MAX6969	16	5.5		—	—
MAX6979				Yes	Yes
MAX6971	16	36		—	—
MAX6983			Yes	Yes	

*Future product—contact factory for availability.

Typical Application Circuit

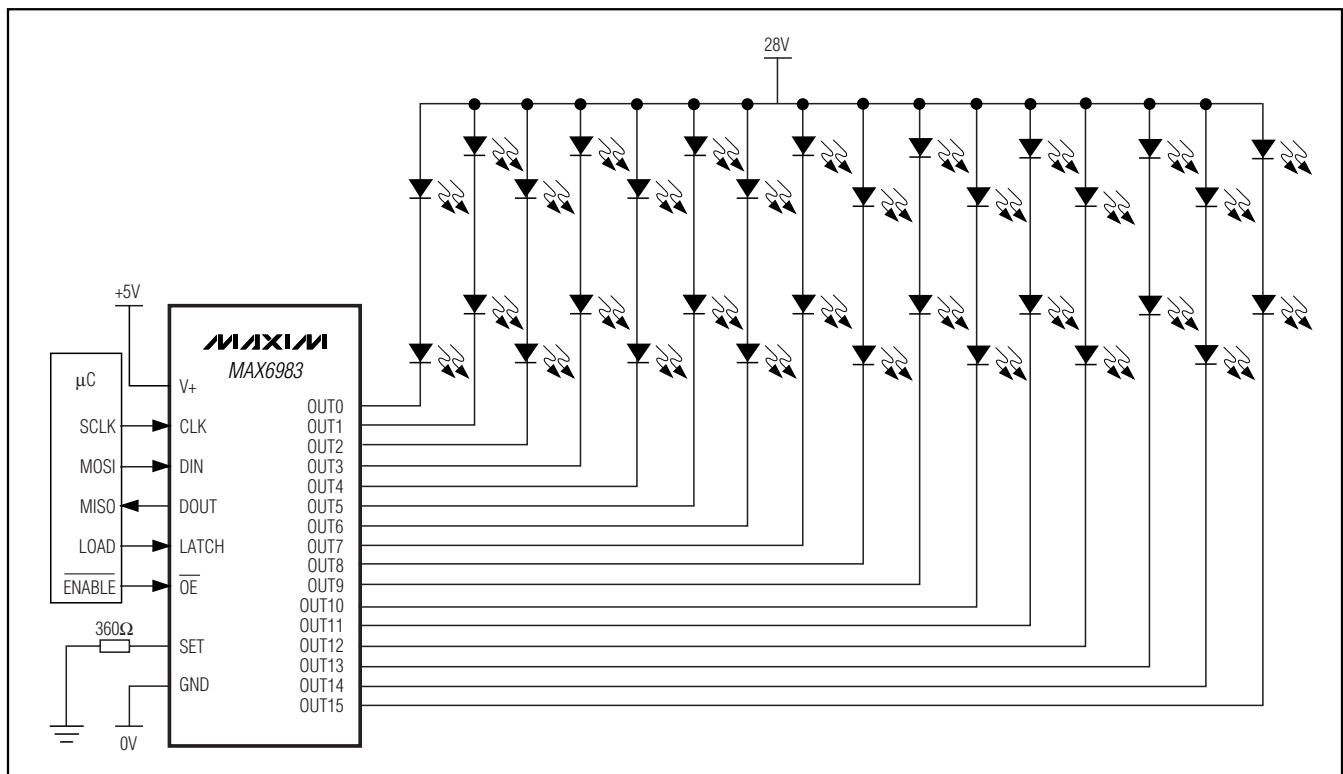

Chip Information

PROCESS: BiCMOS

16-Port, 36V Constant-Current LED Driver with LED Fault Detection and Watchdog

Package Information

(The package drawing(s) in this data sheet may not reflect the most current specifications. For the latest package outline information go to www.maxim-ic.com/packages.)

MAX6983

TOP VIEW

BOTTOM VIEW

SIDE VIEW

END VIEW

DETAIL A

LEAD TIP DETAIL

DIMENSION	MILLIMETERS		INCHES	
	MIN.	MAX.	MIN.	MAX.
A	—	1.10	—	.043
A ₁	0.05	0.15	.002	.006
A ₂	0.85	0.95	.033	.037
b	0.19	0.30	.007	.012
b ₁	0.19	0.25	.007	.010
c	0.09	0.20	.004	.008
c ₁	0.09	0.14	.004	.006
D	SEE VARIATIONS		SEE VARIATIONS	
E	4.30	4.50	.169	.177
e	.65 BSC		.026 BSC	
H	6.25	6.55	.246	.258
L	0.50	0.70	.020	.028
N	SEE VARIATIONS		SEE VARIATIONS	
α	0°	8°	0°	8°

JEDEC	N	VARIATIONS				
		MILLIMETERS		INCHES		
		MIN.	MAX.	MIN.	MAX.	
AB-1	14	D	4.90	5.10	.193	.201
AB	16	D	4.90	5.10	.193	.201
AC	20	D	6.40	6.60	.252	.260
AD	24	D	7.70	7.90	.303	.311
AE	28	D	9.60	9.80	.378	.386

NOTES:

1. DIMENSIONS D AND E DO NOT INCLUDE FLASH
2. MOLD FLASH OR PROTRUSIONS NOT TO EXCEED 0.15mm PER SIDE
3. CONTROLLING DIMENSION, MILLIMETER
4. MEETS JEDEC OUTLINE MO-153. SEE JEDEC VARIATIONS TABLE
5. "N" REFERS TO NUMBER OF LEADS
6. THE LEAD TIPS MUST LIE WITHIN A SPECIFIED ZONE. THIS TOLERANCE ZONE IS DEFINED BY TWO PARALLEL PLANES. ONE PLANE IS THE SEATING PLANE, DATUM [-C-]; THE OTHER PLANE IS AT THE SPECIFIED DISTANCE FROM [-C-] IN THE DIRECTION INDICATED

-DRAWING NOT TO SCALE-

DALLAS SEMICONDUCTOR **MAXIM**

TITLE: PACKAGE OUTLINE, TSSOP 4.40mm BODY

APPROVAL: _____ DOCUMENT CONTROL NO. 21-0066 REV. G 1/1

TSSOP4.40mm.EPS

16-Port, 36V Constant-Current LED Driver with LED Fault Detection and Watchdog

MAX6983

Package Information (continued)

(The package drawing(s) in this data sheet may not reflect the most current specifications. For the latest package outline information go to www.maxim-ic.com/packages.)

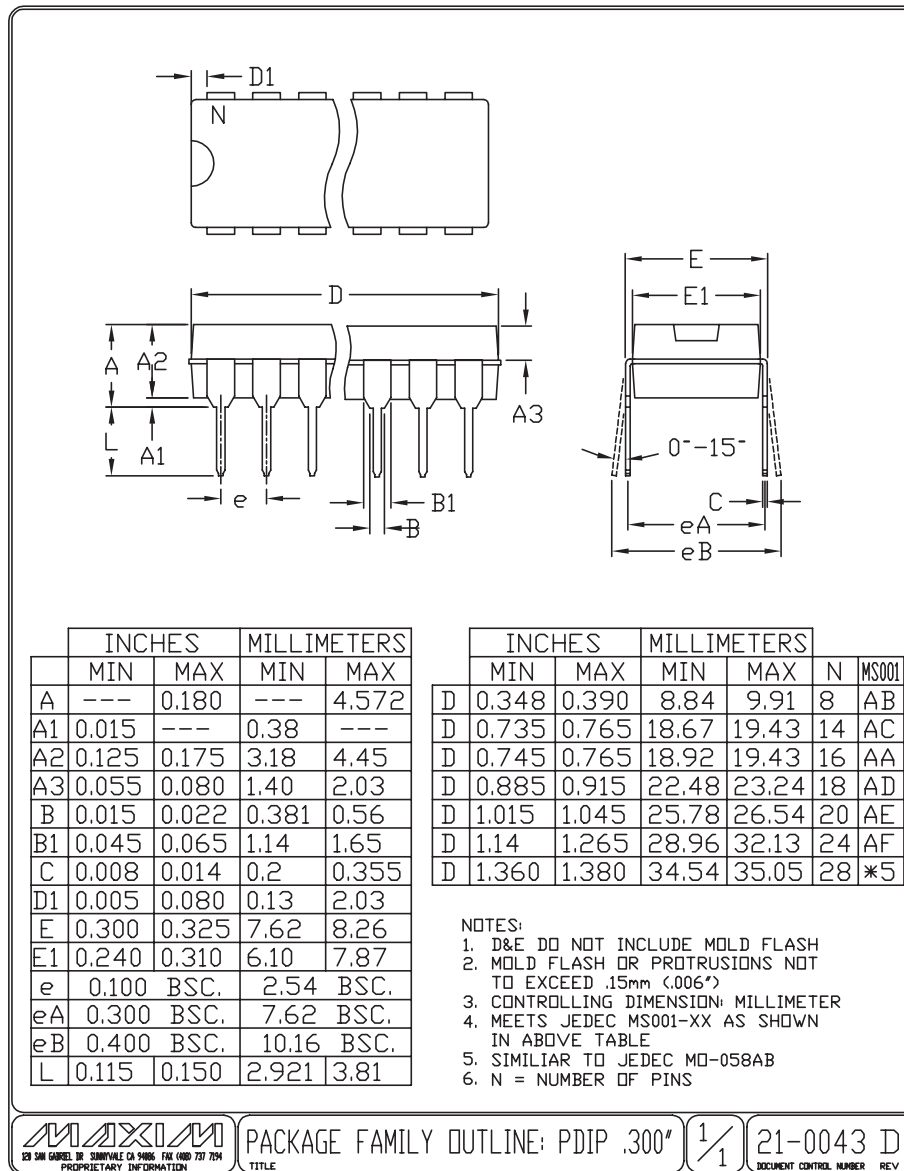

PACKAGE FAMILY OUTLINE: PDIP .300"



21-0043 D
DOCUMENT CONTROL NUMBER REV

Maxim cannot assume responsibility for use of any circuitry other than circuitry entirely embodied in a Maxim product. No circuit patent licenses are implied. Maxim reserves the right to change the circuitry and specifications without notice at any time.

12 Maxim Integrated Products, 120 San Gabriel Drive, Sunnyvale, CA 94086 408-737-7600